

SGC 120 Mk II

Single Genset Controller

Data sheet

4921240652-E



1. SGC 120 Mk II

1.1 About.....	3
1.1.1 Software version.....	3
1.2 Single-line application diagrams.....	3
1.3 Functions.....	4
1.4 Display, buttons, and LEDs.....	6
1.5 Protections overview.....	7

2. Technical specifications

2.1 Electrical specifications.....	9
2.2 Environmental specifications.....	12
2.3 Terminals.....	13
2.4 Approvals.....	14
2.5 Dimensions and weight.....	15

3. Legal information

1. SGC 120 Mk II

1.1 About

The SGC 120 Mk II controller has all the functions needed to protect and control a genset, a genset breaker, and a mains breaker. The values and alarms are shown on the LCD display screen and operators can easily control the system from the display.

Use the controller to monitor engine safety parameters, for example, engine temperature and oil pressure. The controller can also measure voltage and frequency for mains and gensets.

The Smart Connect Mk II software allows you to configure parameters, log data, add custom sensor curves, and supervise live data. M-Logic is also available from the software, which you can use to create functions using predefined events and outputs. The analogue comparator can be used to create custom alarms and logic functions.

1.1.1 Software version

The information in this document relates to software version:

Software	Version
Application software	R18

1.2 Single-line application diagrams

Island mode

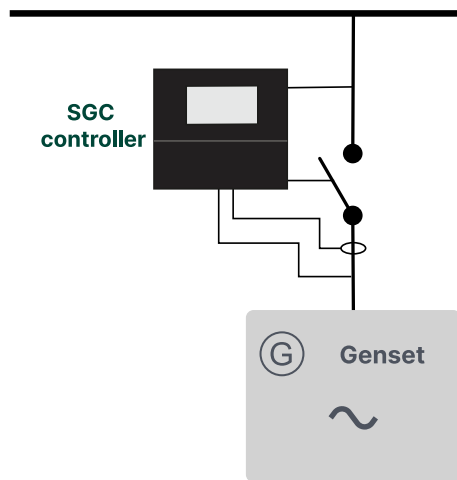

Island: Island mode is typically used in power plants that are isolated from other power generation systems.

Engine drive

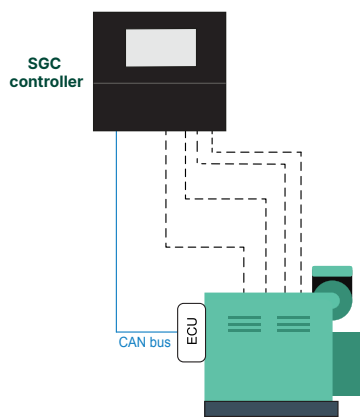

Engine drive: Use the controller to control one engine. The controller has all the necessary functions to control and protect the engine.

Automatic mains failure (AMF), remote start/stop, and auto exercise mode

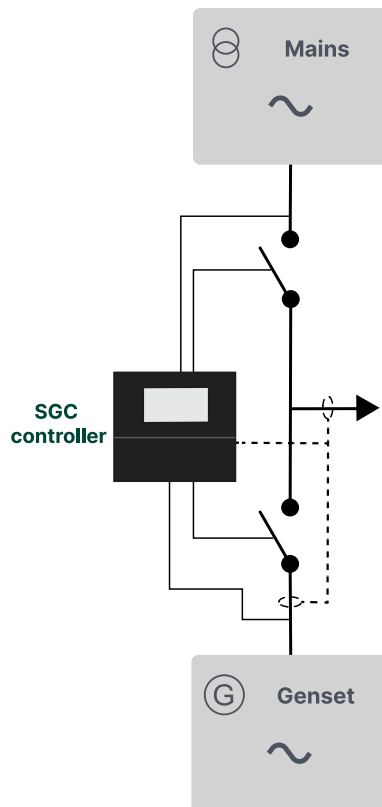

AMF: If there is a significant loss of mains power or a total blackout, the controller automatically changes the supply to the generator. This makes sure that there is power during a mains failure and prevents damage to electrical equipment.

Remote start/stop: Activate the configured start/stop inputs to remotely start or stop the genset.

Auto exercise mode: Use the auto exercise mode to schedule a maximum of two start/stop sequences for the genset. You can also configure the load transfer on the mains/genset.

You can place the CT on the line from the genset or on the load side.

1.3 Functions

Genset functions

Start/stop sequences

Input for genset alternator voltage or D+ charging alternator

Counters, including:

- Engine running hours
- Start attempts
- Energy (kWh, kVAh, kvarh)
- Maintenance

Input for fuel reference selection

Fuel theft alarm

Monitoring of engine and alternator parameters

Idle speed control

Coolant temperature control

Automatic fuel transfer

Mains functions

Mains support (voltage and frequency)

Mains monitoring

Energy counter (kWh, kVAh, kvarh)

General functions

Configurable analogue inputs (mA and V DC, and resistive)

Digital switch inputs

Digital outputs

Event logs with real-time clock

EEPROM for extended event logs

2-level password protection

Change the running mode on the fly

Display and language functions

Supports multiple languages, for example, English, Chinese, and Spanish

Graphical display

Parameters can be changed on the display

Display views change automatically after an adjustable delay time

Deep sleep mode

Smart Connect Mk II

USB interface to PC

Free utility software

Data logging

Configuration comparison tool to compare customised values with default values

Customise and configure the controller display language and the software language

Possible to configure multiple profiles

Custom sensor curves can be added

M-Logic

Logic configuration tool

Selectable input events

Selectable output events

Analogue comparator to compare analogue values, and create custom alarms and logic functions

Use logic rungs to create custom logic

Running modes

MANUAL

AUTO

Modes of operation

Island

Automatic mains failure (AMF)

Remote start/stop

Modes of operation

Auto exercise

Engine drive

Communication

RS-485 for Modbus

USB interface to PC

CAN

Remote Display Controller (RDC)

Remote display functionality using an SGC controller

SGC controller can be configured as a remote display for another SGC master controller

Mirrors operating values, alarms, and system status from the master controller

Can be configured to send control commands to the master controller



Communication via CAN (J1939)





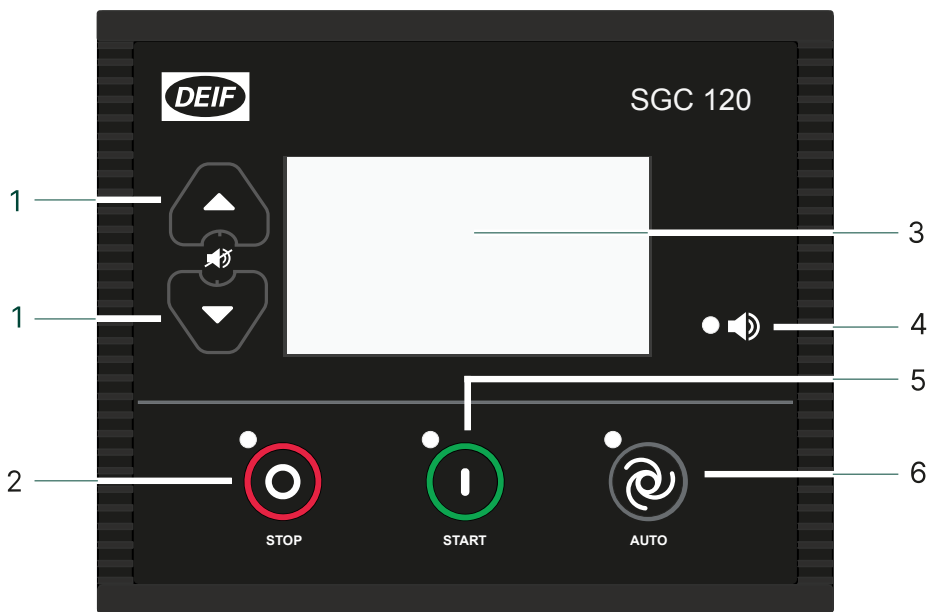



Universal RDC 100 application software available for the SGC series

Any SGC controller can be configured as a remote display using RDC 100

1.4 Display, buttons, and LEDs



No.	Name	Function
1	Navigation	Move the selector up and down on the screen.
2	Stop	Stops the genset if MANUAL or AUTO mode is selected. When you push the button in AUTO, the running mode changes to MANUAL mode.
2	Configuration	To go to the <i>Configuration menu</i> , make sure the controller is in MANUAL mode, and then push and hold the Stop  button until you see the configuration screen. Push the Start  button to select a parameter and to save the changes you have made. To go back to MANUAL mode, push and hold the Stop  button.

No.	Name	Function
		To see the <i>Event log</i> , make sure the controller is in the <i>Configuration menu</i> . Then push the <i>Up</i>  button and the <i>Down</i>  button at the same time and hold until you see the event log. To go back to the <i>Configuration menu</i> , push the <i>Down</i>  and <i>Up</i>  buttons at the same time and hold.
2 and 1	Programming	To go to the <i>Programming menu</i> , make sure the controller is in MANUAL mode. Then push the <i>Down</i>  button and the <i>Stop</i>  button at the same time and hold until you see the programming screen. To go back to MANUAL mode, push the <i>Down</i>  and <i>Up</i>  buttons at the same time and hold.
3	Display	Graphical
4	Alarm LED	The LED is red when there is an active alarm.
5	Start	Starts the genset if MANUAL mode is selected.
6	Mode selection	Push to change the running mode.

1.5 Protections overview

Generator protections

Protections	No. of	ANSI
Under-voltage	x2	27P
Over-voltage	x2	59
Under-frequency	x2	81U
Over-frequency	x2	81O
Unbalanced load	x1	-
Over-current	x1	50TD
Overload	x1	32F
Low load	x1	-
Reverse power	x1	32R
Phase reversal detection	x1	-

Engine protections

Protections	No. of	ANSI
Under-speed	x1	14
Over-speed	x1	12
Configurable crank connect	x1	-
Battery monitoring	x1	-
Charging alternator	x1	-
Pre-heat	x1	-
Coolant temperature	x1	-
Lube oil pressure	x1	-
Fuel level detection	x1	-
Fuel theft detection	x1	-

Protections	No. of	ANSI
ECU communication failure	x1	-
ECU diagnostic lamps	x1	-

Mains protections

Protections	No. of	ANSI
Under-voltage	x1	27P
Over-voltage	x1	59
Under-frequency	x1	81U
Over-frequency	x1	81O
Phase reversal detection	x1	-

2. Technical specifications

2.1 Electrical specifications

Power supply	
Controller terminals	1 (Ground) 2 (Battery or DC+)
Supply voltage range	Nominal voltage: 12/24 V DC Operating range: 8 to 28 V DC
Cranking dropout period	50 ms
Maximum reverse voltage protection	-32 V DC
Measurement accuracy (battery voltage)	±1 % full scale
Resolution	0.1 V
Maximum current consumption	~ 200 mA, 12/24 V DC (not including the current load for the DC outputs)
Standby current consumption (LCD backlight off)	124 mA, 12 V DC 123 mA, 24 V DC
Deep sleep current	20 mA, 12/24 V DC

Genset voltage and frequency measurements	
Controller terminals	27 (Neutral) 28 (L3) 29 (L2) 30 (L1)
Measurement type	True RMS
Phase-to-neutral voltage	32 to 300 V AC RMS
Phase-to-phase voltage	32 to 520 V AC RMS
Voltage accuracy	±1 % of full scale for phase-to-neutral ±2 % of full scale for phase-to-phase
Voltage resolution	1 V AC RMS for phase-to-neutral 2 V AC RMS for phase-to-phase
Frequency range	5 to 75 Hz
Frequency accuracy	0.25 % of full scale
Frequency resolution	0.1 Hz

NOTE For single phase applications, it is mandatory to connect:

- The genset phase (L1) to terminal 30 on the controller.
- The genset neutral to terminal 27 on the controller.

Genset current measurements	
Controller terminals	39 and 40 (for phase L1) 37 and 38 (for phase L2) 35 and 36 (for phase L3)
Measurement type	True RMS
Maximum CT secondary current rating	-/5 A CT -/1 A CT

Genset current measurements

Burden	0.25 VA
Measurement accuracy	±1.4 % of nominal

NOTE Use the recommended phase sequence when you connect the current transformer (CT).

Mains voltage and frequency measurements

Controller terminals	31 (Neutral) 32 (L3) 33 (L2) 34 (L1)
Measurement type	True RMS
Phase-to-neutral voltage	32 to 300 V AC RMS
Phase-to-phase voltage	32 to 520 V AC RMS
Voltage accuracy	±2 % of full scale for phase-to-neutral ±2.5 % of full scale for phase-to-phase
Voltage resolution	1 V AC RMS for phase-to-neutral 2 V AC RMS for phase-to-phase
Frequency range	5 to 75 Hz
Frequency accuracy	0.25 % of full scale
Frequency resolution	0.1 Hz

NOTE For single phase applications, it is mandatory to connect:

- The mains phase (L1) to terminal 34 on the controller.
- The mains neutral to terminal 31 on the controller.

Digital inputs

Controller terminals	10, 11, 12, 21, and 22
Number of inputs	5
Type	Negative switching
Maximum input voltage	+32 V
Minimum input voltage	-24 V
Current source	2.42 mA to 7.27 mA (depends on the battery voltage)
Configurable parameters with software	For example, high water temperature

Analogue resistive sensor inputs

Controller terminals	24, 25, and 26 (configurable)
Number of inputs	3
Type	Ratio-metric sensing
Range	0 to 5000 Ω
Open circuit detection	Above 5.5 k Ω
Measurement accuracy	±2 % of full scale (up to 1000 Ω)

Analogue inputs used as digital inputs

You can use analogue inputs as digital inputs. See **Analogue inputs used as digital inputs** in the SGC 120 Mk II User manual for how to wire the analogue inputs and configure the parameters.

Analogue voltage/current inputs

Controller terminal	23 (configurable)
Measurement type	Analogue voltage/current sensing
Range	0 to 5 V DC 4 to 20 mA
Accuracy	±2 % of full scale voltage ±1.25 % of full scale current
Resolution	0.1 V 0.1 mA

Magnetic pickup (MPU) input / W-point frequency input

Controller terminal	42
Measurement type	Single-ended
Frequency range	10 Hz to 10 kHz
Input voltage range	200 mV to 45 V AC RMS

D+ charger alternator

Controller terminal	7
Voltage range	0 to V_{BATT} $V_{BATT} = 8$ to 32 V DC
Excitation	PWM (power limited to 3 W, 12 V/250 mA)
Accuracy	±1 % of full scale

Sensor common point (SCP)

Controller terminal	41
Range	±2 V
Accuracy	±2 % of full scale

NOTE Connect terminal 41 (SCP) to a solidly grounded point on the engine, for example the engine frame. Do not share the cable used for this connection with other electrical connections.

Communication ports

USB	USB 2.0 type B for connection to PC with Smart Connect Mk II
RS-485 serial port	Half duplex Max. baud rate: 115200 bps Data connection: 2-wire Maximum distance of line: 200 m Bus-pin fault protection: max. ±70 V Common-mode operating range Built-in termination resistor of 120 Ω between output terminals A and B (internally mounted)
Controller terminals	15 and 16

Communication ports

CAN	Baud rate: 250 kbps Packet size: 8 bytes Built-in termination resistor of 120 Ω between output terminals A and B (internally mounted)
Controller terminals for CAN	13 and 14

Digital outputs

Controller terminals	3, 4, 5, 6, 8, and 9
Number of outputs	6
Type	DC outputs
Maximum current rating	Max. for each output: 500 mA Total max.: 1 A
Configurable parameters with software	For example, start relay or fuel relay.

2.2 Environmental specifications

Operation conditions

Operating temperature	-20 to +65 °C (-4 to +149 °F). To IEC 60068-2-1, 2
Storage temperature	-30 to +75 °C (-22 to +167 °F). To IEC 60068-2-1, 2
Vibration	3G in X, Y and Z axes for 8 to 500 Hz. To IEC 60068-2-6
Shock	15 g for 11 ms. To IEC 60068-2-27
Humidity	0 to 95 % RH. To IEC 60068-2-78
Protection degree	IP65 (front of module when installed into the control panel with the supplied sealing gasket). To IEC 60529
EMI/EMC	IEC 61000-6-2, 4

2.3 Terminals

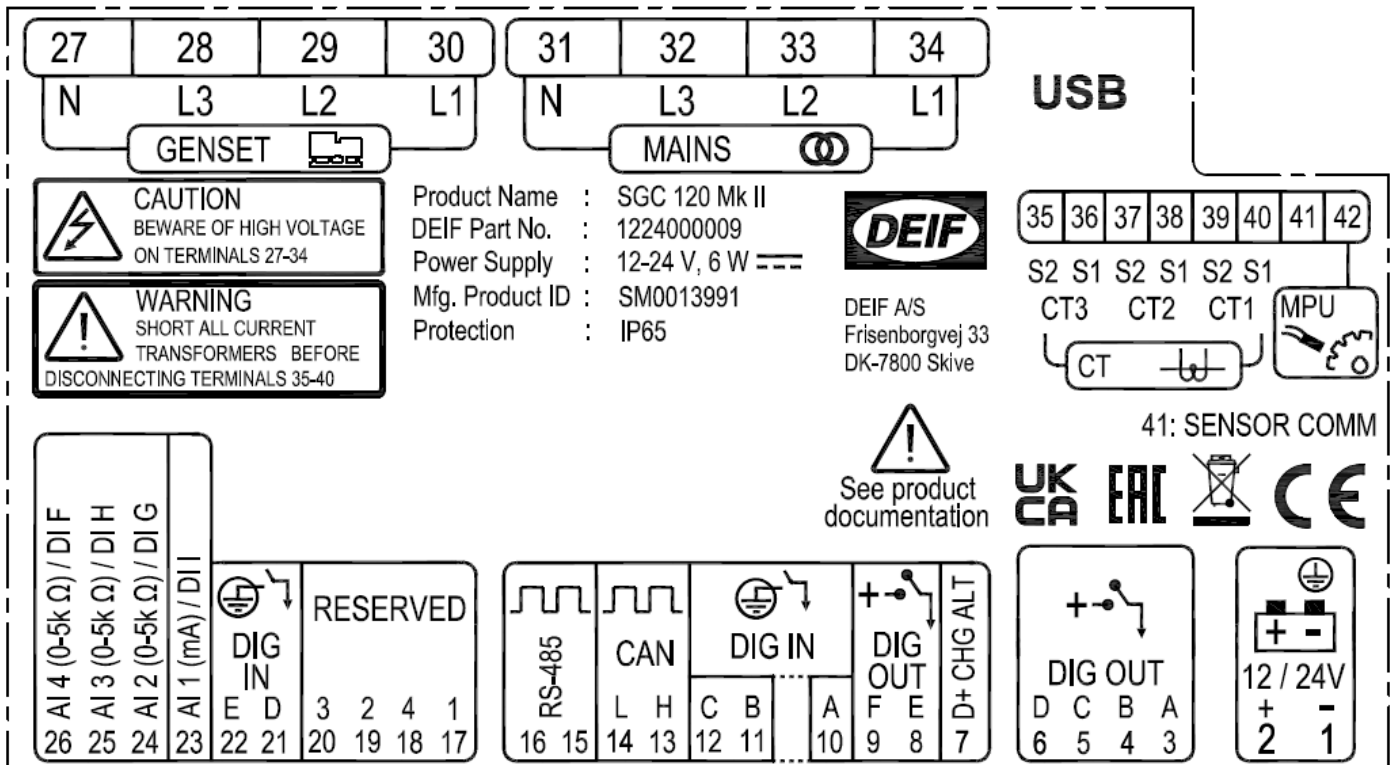

Terminal	Text	Description
1	GND	Power ground
2	BATT +	Power supply positive
3	DIG OUT A	DC output - A
4	DIG OUT B	DC output - B
5	DIG OUT C	DC output - C
6	DIG OUT D	DC output - D
7	D+ CHG ALT	Input for charging alternator control
8	DIG OUT E	DC output - E
9	DIG OUT F	DC output - F
10	DIG IN A	Input from switch A
11	DIG IN B	Input from switch B
12	DIG IN C	Input from switch C
13	CAN H	CAN high
14	CAN L	CAN low
15	RS-485 B	RS-485 B
16	RS-485 A	RS-485 A
17	Reserved	-
18	Reserved	-
19	Reserved	-
20	Reserved	-

Terminal	Text	Description
21	DIG IN D	Input from switch D
22	DIG IN E	Input from switch E
23	AI 1 (mA) / DI I	Analogue input from list of sensors/digital input I
24	AI 2 (0-5k Ω) / DI G	Analogue input from list of sensors/digital input G
25	AI 3 (0-5k Ω) / DI H	Analogue input from list of sensors/digital input H
26	AI 4 (0-5k Ω) / DI F	Analogue input from list of sensors/digital input F
27	GENSET N	Voltage input from generator neutral
28	GENSET L3	Voltage input from generator phase L3
29	GENSET L2	Voltage input from generator phase L2
30	GENSET L1	Voltage input from generator phase L1
31	MAINS N	Voltage input from mains neutral
32	MAINS L3	Voltage input from mains phase L3
33	MAINS L2	Voltage input from mains phase L2
34	MAINS L1	Voltage input from mains phase L1
35	CT3 S2	CT input 2 from generator phase L3 (max. 2.5 mm ²)
36	CT3 S1	CT input 1 from generator phase L3 (max. 2.5 mm ²)
37	CT2 S2	CT input 2 from generator phase L2 (max. 2.5 mm ²)
38	CT2 S1	CT input 1 from generator phase L2 (max. 2.5 mm ²)
39	CT1 S2	CT input 2 from generator phase L1 (max. 2.5 mm ²)
40	CT1 S1	CT input 1 from generator phase L1 (max. 2.5 mm ²)
41	SENSOR COMM	Sensor common point
42	MPU	MPU input

2.4 Approvals

Standards
CE
UL/cUL Recognized to UL/ULC6200:2019 1st edition

NOTE Refer to deif.com for the most recent approvals.

2.5 Dimensions and weight

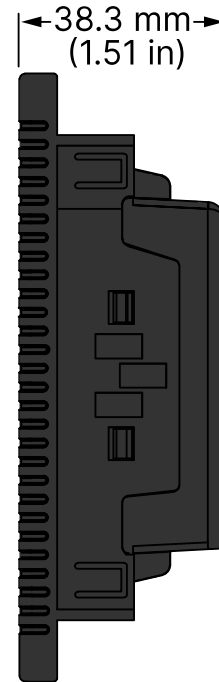
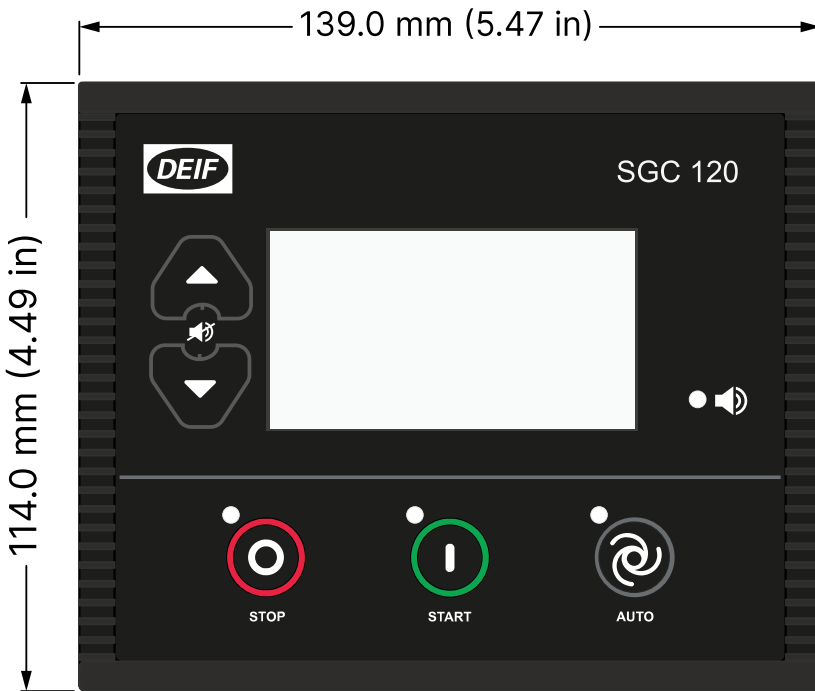
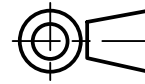

Dimensions

Dimensions	Length: 139.0 mm (5.47 in) Height: 114.0 mm (4.49 in) Depth: 38.3 mm (1.51 in)
Panel cut-out	Length: 118.0 mm (4.65 in) Height: 93.0 mm (3.66 in) Tolerance: ± 0.3 mm (0.01 in)
Weight	With lock: 289 g Without lock: 276 g

3. Legal information

Warranty

NOTICE



Warranty

The controller is not to be opened by unauthorised personnel. If opened anyway, the warranty will be lost.

Disclaimer

DEIF A/S reserves the right to change any of the contents of this document without prior notice.

The English version of this document always contains the most recent and up-to-date information about the product. DEIF does not take responsibility for the accuracy of translations, and translations might not be updated at the same time as the English document. If there is a discrepancy, the English version prevails.

Copyright

© Copyright DEIF A/S. All rights reserved.