

Interfacing DEIF equipment to governors and AVR

Application notes



1. Delimitation	
1.1 Scope of application notes Interfacing DEIF equipment to governors and AVRs.....	5
2. General information	
2.1 Warnings, legal information and safety.....	6
2.1.1 Warnings and notes.....	6
2.1.2 Legal information and disclaimer.....	6
2.1.3 Safety issues.....	6
2.1.4 Electrostatic discharge awareness.....	6
2.1.5 Factory settings.....	7
2.2 About the Application Notes.....	7
2.2.1 General purpose.....	7
2.2.2 Intended users.....	7
3. Abbreviations and names	
4. General comments regarding adjustment of governors and AVRs	
4.1 DEIF PI step regulators.....	9
4.2 DEIF PI analogue output regulators.....	9
5. Commissioning	
5.1 The prime mover and generator.....	10
5.2 Speed droop on speed governor.....	10
5.3 Voltage droop on AVR.....	10
5.4 Initial setting of speed governor/AVR.....	10
5.4.1 With relay output(s) directly connected.....	10
5.4.2 With analogue output.....	10
5.4.3 With Multi-line 2 PPU/PPM/GPC/AGC PWM output for Caterpillar®.....	11
5.5 Adjusting DEIF controllers.....	11
5.5.1 Delomatic/PPU/PPM/GPC/AGC/AGC 200/BGC.....	11
5.5.2 Analogue output PI.....	11
5.5.3 Relay output PI step.....	12
5.5.4 Resulting speed/voltage curve upon load change.....	12
5.6 Adjusting Uni-line load sharers and synchronisers.....	13
5.6.1 Resulting speed/voltage curve upon load change.....	14
6. Governor interface basic circuits	
6.1 Direct analogue controls.....	15
6.2 Combined analogue controls.....	15
7. Governor interfaces	
7.1 Barber-Colman DYNA 1.....	17
7.2 Barber-Colman DYNA DPG 2200 governor.....	17
7.3 Barber-Colman DYNA 8000 governor.....	17
7.4 Barber-Colman DYNA 1 digital controllers.....	18
7.4.1 Model DYN1 10502/3/4/6.....	18
7.4.2 Model DYN1 DYNA 2000.....	18
7.4.3 Model DYN1 10871.....	18
7.4.4 Model DYN1 10794.....	19
7.5 Caterpillar® ADEM engine controller.....	19
7.6 Caterpillar® PEEC engine controller.....	19
7.7 Caterpillar® Pulse Width Modulator converter.....	20

7.8 Cummins EFC governor.....	20
7.9 Cummins ECM controller.....	21
7.10 Cummins Power Command Control (PCC) load sharing system and Multi-line 2.....	21
7.11 Detroit Diesel DDEC-III/DDEC-IV electronic governor.....	22
7.12 Deutz EMR electronic controller.....	22
7.13 GAC type ESD 5111, 5221 and 5131.....	23
7.13.1 Combined analogue control.....	23
7.14 GAC type ESD 5300 and 5330.....	23
7.15 GAC type ESD 5500.....	23
7.15.1 Combined analogue control.....	24
7.16 Heinzmann type E1-D and E1-F speed governor.....	24
7.17 Heinzmann type E6, E6V, E10, E16 and E30 speed governor.....	25
7.18 Heinzmann Olympus for gas turbines.....	25
7.19 Heinzmann KG 6 - 04 to KG10 - 04.....	25
7.20 MTU MDEC 4000 controller.....	26
7.21 Perkins type ECM controller.....	26
7.22 SCANIA type DEC2 controller.....	26
7.23 TOHO electronic governor speed controller XS-400B-03.....	27
7.24 Volvo type EMS2 controller.....	27
7.25 Woodward type 1724 and 1712 governor.....	28
7.26 Woodward type 2301A speed control governor.....	28
7.27 Woodward type 2301A load sharing.....	28
7.28 Woodward type 701A.....	28
7.29 Woodward 721 digital speed control.....	29
7.30 Woodward generator load sensor.....	29
7.31 Woodward L-series governor.....	30
7.32 Woodward ProAct digital speed control system type I and II.....	30
7.33 Woodward PEAKTM 150 digital control for steam turbines.....	30
7.34 Woodward UG8 digital control.....	30
8. CANbus engine controller interface	
8.1 CANbus interface.....	32
8.2 DEIF unit terminals.....	32
8.3 CANbus J1939 engine unit terminals.....	32
8.4 MTU terminals.....	33
8.5 Huegli Tech HT-SG-100 speed governor.....	33
9. AVR interface basic circuits	
9.1 Direct analogue controls.....	35
9.2 Combined analogue controls, 3-wire.....	35
9.3 Combined analogue controls, 2-wire.....	36
10. AVR interfaces	
10.1 AVK Cosimat AVR.....	37
10.2 Basler Electric AEC63-7 AVR.....	37
10.3 Basler Electric digital excitation control system (DECS).....	38
10.4 Basler Electric SR 4A/6A/8A/9A/32A AVR.....	38
10.5 Basler Electric SSR 32-12, 63-12, 125-12 AVR.....	38
10.6 Caterpillar® VR3.....	39
10.7 Caterpillar® VR6.....	39
10.8 Caterpillar® DVR.....	40

10.9 Caterpillar® CDVR.....	40
10.10 Leroy Somer type R250/R438/R448/R449 LS/C or D AVR.....	41
10.11 Leroy Somer type R450 AVR.....	42
10.12 Leroy Somer type R610 AVR.....	43
10.13 Leroy Somer type R610 3F AVR.....	43
10.14 Marathon Magnamax/DVR 2000C AVR.....	43
10.15 Marelli Mark 1 AVR.....	44
10.16 Marelli M25FA502A.....	44
10.17 Mecc-Alte S.R.7/2.....	44
10.18 Mecc-Alte type U.V.R. AVR.....	44
10.19 Stamford Newage type MA325, MA327, MX321, MX341, SR465, SX421 and SX440.....	45

11. Troubleshooting

1. Delimitation

1.1 Scope of application notes Interfacing DEIF equipment to governors and AVRs

This document includes application notes for interfacing DEIF's equipment to governors and AVRs and covers the following DEIF products:

Uni-line series	A complete range of single-function components for generator control and -protection
Multi-line series	A complete range of multi-function components for generator control and -protection
Delomatic	A multi-functional system for power management and generator control and -protection

2. General information

2.1 Warnings, legal information and safety

2.1.1 Warnings and notes

Throughout this document, a number of warnings and notes with helpful user information will be presented. To ensure that these are noticed, they will be highlighted as follows in order to separate them from the general text.

Warnings



DANGER!



This shows dangerous situations.

If the guidelines are not followed, these situations will result in death, serious personal injury, and equipment damage or destruction.

Notes

NOTE Notes provide general information, which will be helpful for the reader to bear in mind.

2.1.2 Legal information and disclaimer

DEIF takes no responsibility for installation or operation of the generator set. If there is any doubt about how to install or operate the engine/generator controlled by the DEIF unit, the company responsible for the installation or the operation of the set must be contacted.



DANGER!

The DEIF unit is not to be opened by unauthorised personnel. If opened anyway, the warranty will be lost.

Disclaimer

DEIF A/S reserves the right to change any of the contents of this document without prior notice.

The English version of this document always contains the most recent and up-to-date information about the product. DEIF does not take responsibility for the accuracy of translations, and translations might not be updated at the same time as the English document. If there is a discrepancy, the English version prevails.

2.1.3 Safety issues

Installing and operating the DEIF unit may imply work with dangerous currents and voltages. Therefore, the installation should only be carried out by authorised personnel who understand the risks involved in working with live electrical equipment.



DANGER!

Be aware of the hazardous live currents and voltages. Do not touch any AC measurement inputs as this could lead to injury or death.

2.1.4 Electrostatic discharge awareness

Sufficient care must be taken to protect the terminals against static discharges during the installation. Once the unit is installed and connected, these precautions are no longer necessary.

2.1.5 Factory settings

The DEIF unit is delivered from factory with certain factory settings. These are based on average values and are not necessarily the correct settings for matching the engine/generator set in question. Precautions must be taken to check the settings before running the engine/generator set.

2.2 About the Application Notes

2.2.1 General purpose

This document includes application notes for interfacing DEIF's equipment of the Uni-line, Multi-line 2 and Delomatic series to governors and AVRs. It mainly includes examples of different applications suitable for the unit.



INFO

For functional descriptions, the procedure for parameter setup, parameter lists etc., please see the relevant documentation for the equipment in question.

The general purpose of the application notes is to offer the designer information about suitable applications interfacing to governors and AVRs.



DANGER!

Please make sure to read the relevant documentation before starting to work with the DEIF unit and the gen-set to be controlled. Failure to do this could result in human injury or damage to the equipment.

2.2.2 Intended users

The Application Notes are mainly intended for the person responsible for designing systems. In most cases, this would be a panel builder designer. Naturally, other users might also find useful information in this document.

3. Abbreviations and names

The following abbreviations and names are used for DEIF units:

- Uni-line: A family of single-function components. The Uni-line synchronisers and load sharers all have relay control outputs.
- EPQ96 and EPN-110DN: Electronic potentiometers giving a DC voltage output.
- Multi-line 2: A family of multi-functional components. These have relay control outputs as standard (for both speed governor and AVR), and analogue (+/-20 mA) as well as Pulse Width Modulated (PWM) outputs as option.
 - PPU: Paralleling and Protection Unit.
 - GPC: Generator Paralleling Controller.
 - AGC (AGC-4 Mk II, AGC-4, AGC 200, AGC-3, AGC Plant Management): Automatic Generator Controller (Automatic Mains Failure unit with engine control).
 - In general, information for AGC-4 also applies to AGC-4 Mk II.
 - BGC: Basic Generator Controller (Automatic Mains Failure unit with limited control functions).
 - PPM: Protection and Power Management (power management system for ships).
- Delomatic: A multi-functional system capable of power management functions besides all generator control and protection functions.
 - SCM-1: Generator control plug-in module in Delomatic 3 with relay or analogue outputs for speed governor and AVR.
 - SCM 4.2: Generator control plug-in module in Delomatic 4 with relay or analogue outputs for speed governor and AVR.

4. General comments regarding adjustment of governors and AVR

4.1 DEIF PI step regulators

PI step regulator is a commonly used regulator for speed control. Also when interfacing to an electronic governor/AVR without capability for binary inputs. In this case an electronic potentiometer type EPQ96 or EPN-110DN is used to convert the relay outputs from PI step regulator into an analogue signal which can be used by the governor/AVR.

Usually, the most accepted signals are voltage signals.

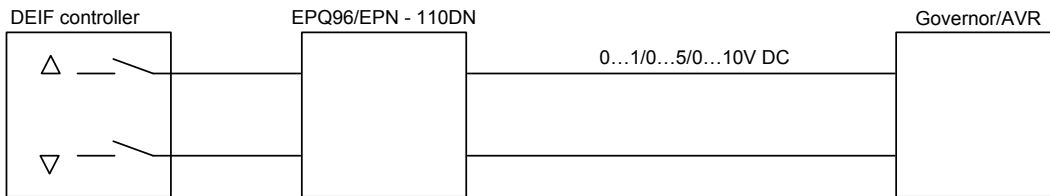

4.2 DEIF PI analogue output regulators

Only max. scale outputs are shown in the following. Any scaling within the max. values can be achieved.

The DEIF analogue output regulators are available in:

- | | |
|--|--|
| - Delomatic multi-function generator control and protection system | +/-20 mA |
| - Multi-line 2 units AGC, PPU, PPM and GPC | +/-20 mA, PWM |
| - Multi-line 2 unit BGC | +/-20 mA |
| - Electronic potentiometers EPQ96 and EPN-110DN | +/-1/5/10V DC |
| - Electronic potentiometer EPQ96-2 | +/-20 mA
+/-1/5/10V DC
PWM |
| - IOM 200 external IO module for AGC 200 | +/-20 mA
0-20 mA
+/-1/5/10V DC
0-1/5/10 V |

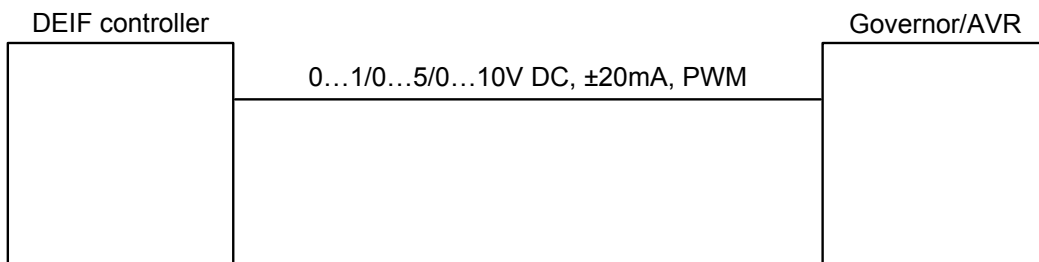

5. Commissioning

5.1 The prime mover and generator

The prime mover can be diesel engine, gas engine, gas turbine or steam turbine. The type of prime mover is unimportant. The generator must be a synchronous generator with adjustable Automatic Voltage Regulator (AVR).

5.2 Speed droop on speed governor

The speed governor **is recommended to have a speed droop of 3-4%** (speed dropping 3-4% from no load to full load when the DEIF equipment is not in control). To ensure equal load sharing on parallel running machines, all governors must have the same droop setting.



INFO

Since the DEIF units all contain frequency as well as power control facilities and use these for control simultaneously, the resulting system will be isochronous (without speed droop), even though the governors are adjusted with droop.



INFO

Even though speed droop is recommended, the DEIF units AGC, AGC 200, BGC, PPU, PPM and GPC can control isochronous speed governors (without droop) when using analogue/PWM/engine communication output for speed control. Delomatic 3/4 and Uni-line always require droop.

5.3 Voltage droop on AVR

The AVR controls the generator voltage in a manner comparable to the speed governor controlling the prime mover speed.

This means that **the generator AVR must have a voltage droop of 3-4%** (voltage dropping 3-4% from no load to full load when the DEIF equipment has no control). To ensure equal VAR sharing on parallel running generators, the voltage droop must be the same for all generators.



INFO

Since the DEIF units all have options for voltage as well as reactive power/power factor control facilities and use these for control simultaneously, the resulting system, if the option is selected, will be with fixed voltage (without voltage droop) even though the AVRs are adjusted with droop.

5.4 Initial setting of speed governor/AVR

5.4.1 With relay output(s) directly connected

- Disable the outputs from the DEIF controller(s).
- Run the generator with no load.
- Adjust the frequency (on the speed governor) to be base frequency (50 or 60 Hz) plus 50% of the droop (4% droop means +2% = 1 Hz for 50 Hz).
- Adjust the generator voltage (on the AVR) to nominal voltage plus 50% of the voltage droop (4% voltage droop means +2%).

5.4.2 With analogue output

The analogue output from Delomatic/PPU/PPM/GPC/AGC/BGC is +/-20 mA, which in most cases must be converted into a voltage using a resistor across the terminals (250 Ω gives 5V DC at 20 mA).

AGC 200 has no analogue outputs, so if needed, the IOM 200 series external IO module must be used.

As especially governors are sensitive to the external circuit impedance, it is essential that the initial settings of speed governor/AVR are done with the analogue output connected, but disabled (electronic potentiometer: Turn off the power supply; Delomatic: Set in SWBD mode; Multi-line: Set in MAN mode). If you fail to do this, you may experience control problems later on. The only exception from this rule is the Woodward load sensor (please see the chapter Woodward generator load sensor). After this, you adjust the frequency response:

- Run the generator with no load.
- Adjust the frequency (on the speed governor) to be base frequency (50 or 60 Hz) plus 50% of the droop (4% droop means +2% = 1 Hz for 50 Hz).
- Adjust the generator voltage (on the AVR) to nominal voltage plus 50% of the voltage droop (4% voltage droop means +2%).
- The output range from the DEIF unit must equal nominal frequency +/-2%.

After this, you can activate the AUTO input again.

5.4.3 With Multi-line 2 PPU/PPM/GPC/AGC PWM output for Caterpillar®

Since the PWM initial setting has an influence on the start-up speed of the engine, the first thing to do is to set this (setting 2272 for Multi-line, 2662 for AGC/PPM):

- Make sure that the generator cannot start.
- Turn the PPU/PPM/GPC/AGC OFF and ON again (to make sure that the PWM output is reset).
- Start the generator (no load).
- Adjust setting 2272/2662 until the correct speed (and frequency) is achieved.



INFO

PWM output is not possible on an AGC 200.

5.5 Adjusting DEIF controllers

The first attempt is always an "I hope settings are OK". For this purpose, DEIF has with experience gained over the years come to some initial settings, which may not be perfect but can be used to start the adjustment of regulators/controllers.

Adjusting PI (Proportional Integral) step regulators (with relay outputs) and PID (Proportional Integral Differential) (with analogue outputs) controllers is not easy. The following is a shortcut, giving you an acceptable result (maybe not perfect, but acceptable).

5.5.1 Delomatic/PPU/PPM/GPC/AGC/AGC 200/BGC

The equipment is delivered with a factory setting, which will be acceptable in 90% of the cases. Start the generator and test it. The worst thing that can happen is a generator trip, in which case a new attempt must be made.

5.5.2 Analogue output PI

The analogue speed output can be used for engines with electronic governors.

Both Delomatic and PPU/PPM/GPC/AGC/AGC 200/BGC accept push-button inputs for manual speed control and can be connected directly, even if manual running is required.

The analogue voltage output can be used for generators with electronic AVRs.

Both Delomatic and PPU/PPM/GPC/AGC/AGC 200/BGC accept push-button inputs for manual voltage control and can be connected directly, even if manual running is required.

The output is +/-20 mA. For IOM 200 units, voltage can be chosen as well.

1. The integral time (the time to compensate for deviations from setpoint) should be as short as possible, but to avoid hunting, the setting is recommended to give a fairly long integral time, so, as a beginning, the integral time (Ki factor in Multi-line) can remain as factory setting.
2. The gain is now adjusted. Increase the value until the speed governor/AVR becomes unstable, and decrease until it stabilises again.
3. Repeat 2., but this time by lowering the integral time (increase Ki in Multi-line, decrease Tn in Delomatic) until instability, and increase the integral time again until stability is reached.
4. The easiest way to test is to use (if possible) a load bank, applying "jumps" in generator load and thereby testing the speed/AVR control.

5.5.3 Relay output PI step

Delomatic and Uni-line:

There are 2 settings: Time pulse, which is the shortest relay "ON" signal time.
 Gain Kp, which is the amplification factor for the proportional part.

The shortest acceptable time pulse time is dependent on the reaction of the governor/AVR and connection type. Slow reaction ⇒ long time pulse.

Multi-line:

Apart from the Kp (proportional gain) and Ki (integrator gain) there are settings for:

- Pulse width time (the output is a Pulse Width Modulated output).
- Shortest acceptable pulse ON length.

Electronic potentiometer:

If an electronic potentiometer is being used to convert the relay signals into analogue value, both the time pulse and the gain factory setting can be used. In this case, the adjustments are easiest done on the electronic potentiometer, gain = a combination of ΔU_o (full scale output) and TIME (sec.). Higher ΔU_o /shorter TIME = higher gain.

Direct connection to mechanical speed governor:

If the connection is directly onto a mechanical governor with pilot motor, it may be necessary to increase the time pulse value. This depends on the mechanical characteristics of the governor system.

After finding the proper time pulse length, the gain Kp is adjusted. Increase the value until the speed becomes unstable, and decrease until it stabilises again.

Direct connection to AVR with binary voltage up/down inputs:

If the connection is directly onto binary inputs, it may be necessary to increase the time pulse value. This depends on the characteristics of the AVR.

After finding the proper time pulse length, the gain Kp is adjusted. Increase the value until the voltage becomes unstable, and decrease until it stabilises again.

5.5.4 Resulting speed/voltage curve upon load change

The easiest way to test is to use (if possible) a load bank, applying "jumps" in generator load and thereby testing the speed/voltage control.

The optimal result should look like this curve:

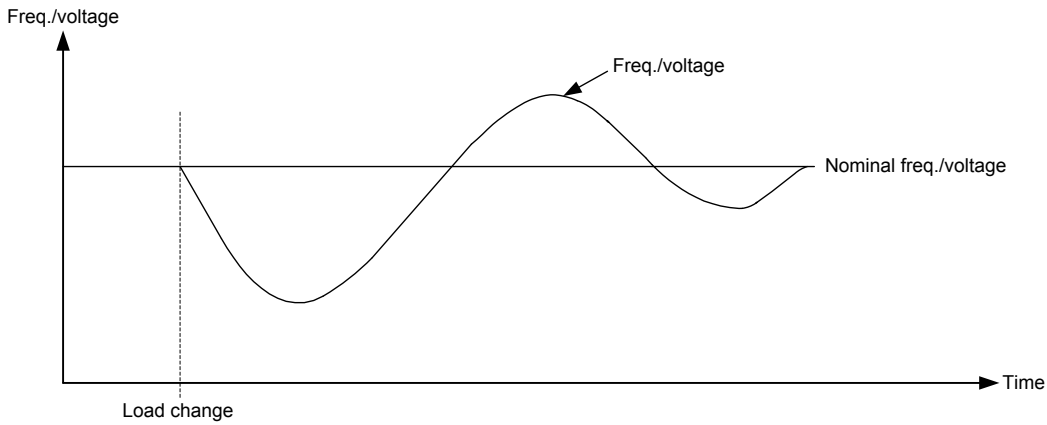

As it can be seen, 2-3 "overshoots" before stabilising after a sudden change are OK.

Gain too high:

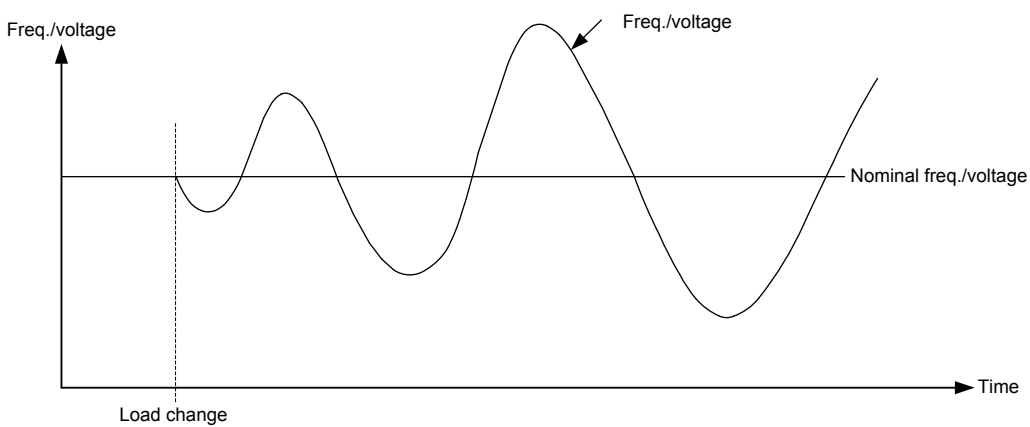

If the gain is too high, the speed/voltage will not reach stability and the hunting may increase over time and eventually cause a trip.

Gain too low:

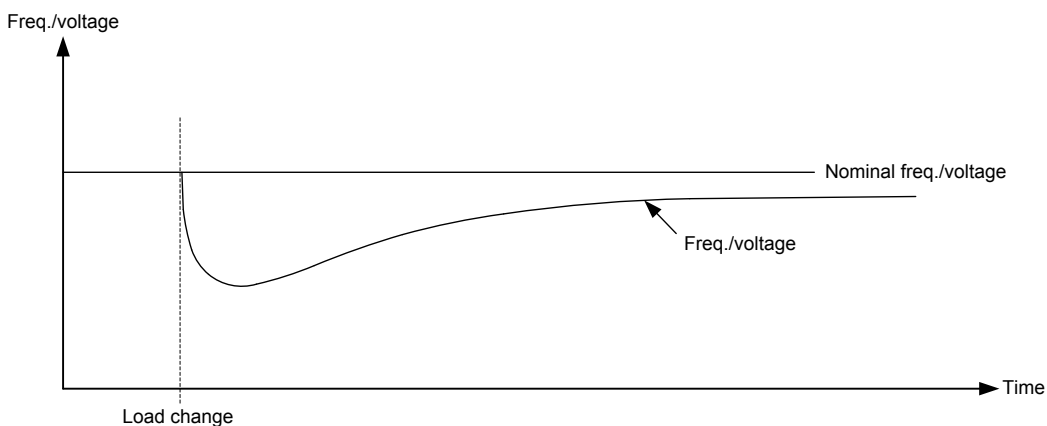

If the gain is too low, the return to nominal takes too long time or may even never happen.

5.6 Adjusting Uni-line load sharers and synchronisers

There are 2 settings: T_n , which is the shortest relay signal "ON" time.

X_p , which is the amplification factor for the proportional part.

The shortest T_n is dependent on the reaction of the governor/AVR and connection type. Slow reaction \Rightarrow longer T_n .

As a beginning, place both potentiometers in centre position.

Electronic potentiometer:

If an electronic potentiometer is being used to convert the relay signals into analogue value, both the time pulse and the gain potentiometer centre position can be used. In this case, the adjustments are done on the electronic potentiometer, gain = a combination of ΔU_o (full scale output) and TIME (sec.). Increase ΔU_o /decrease TIME = increase gain.

Direct connection to mechanical speed governor:

If the connection is directly onto a mechanical governor with pilot motor, it may be necessary to increase the time pulse value. This depends on the mechanical characteristics of the governor system, but the shortest possible time pulse value is preferable.

After finding the proper time pulse length, the gain X_p is adjusted. Increase the value until the speed becomes unstable, and decrease until it stabilises again.

Direct connection to AVR with binary voltage up/down inputs:

If the connection is directly onto binary inputs, it may be necessary to increase the time pulse value. This depends on the characteristics of the AVR. Slower reaction \Rightarrow longer time pulse.

After finding the proper time pulse length, the gain K_p is adjusted. Increase the value until the voltage becomes unstable, and decrease until it stabilises again.



INFO

On the Uni-line synchroniser FAS-115DG, the voltage control relay output settings are fixed and cannot be adjusted. This is done under the assumption that the outputs are used for an electronic AVR or an electronic potentiometer, where adjustments can be made.

5.6.1 Resulting speed/voltage curve upon load change

The easiest way to test is to use (if possible) a load bank, applying "jumps" in generator load and thereby testing the speed/voltage control.

For resulting speed/voltage curves, please refer to the chapter "Resulting speed/voltage curve upon load change".

As it can be seen, 2-3 "overshoots" before stabilising after a sudden change are OK. If more "overshoots" are present, decrease the gain (increase TIME on the electronic potentiometer) and try again.

6. Governor interface basic circuits



INFO

The following contains indications of resistor values. These values are for guidance only, and you may have to change the resistors to obtain proper control. Generally, choosing too big resistors across the +/-20mA outputs from DEIF units will result in unstable control; choosing too small resistors will result in the system being unable to control the generator in the full operating range (0-100% load).

6.1 Direct analogue controls

The direct analogue control utilises the fact that most governors are prepared for external control devices such as synchronisers and load sharers.

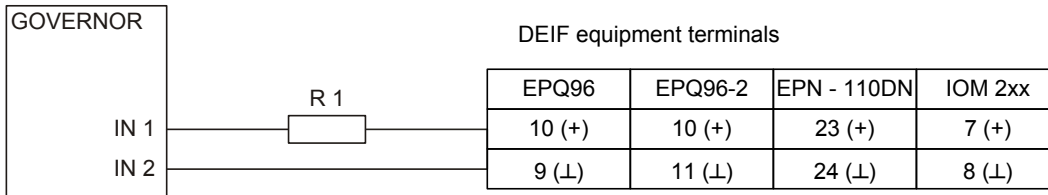

INFO

EPQ96-2 terminals 11-12 must be linked (connected together) to activate the internal 500 Ω shunt in order to create a voltage input.

DELOMATIC/PPU/GPC/AGC/BGC output is +/-20 mA, so a resistor is needed to convert into V DC range:

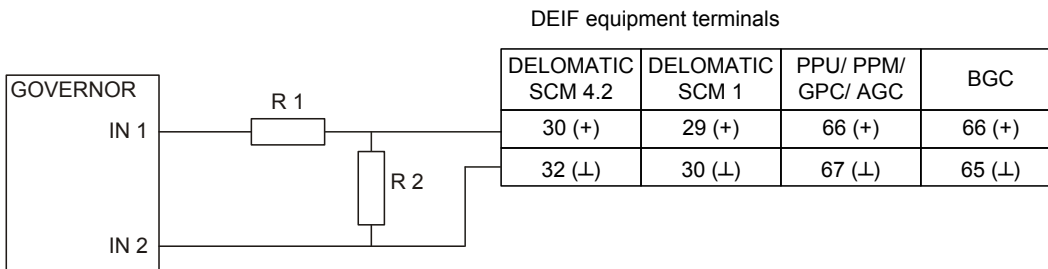

6.2 Combined analogue controls

The combined analogue control uses the combination of the DEIF unit's analogue output and a speed setting potentiometer.

The advantage of this solution is the possibility to do basic speed settings with the potentiometer and thereafter let the DEIF unit take over.



INFO

If the potentiometer is only used for initial adjustments, it can be replaced by fixed resistors, once the adjustment is done.

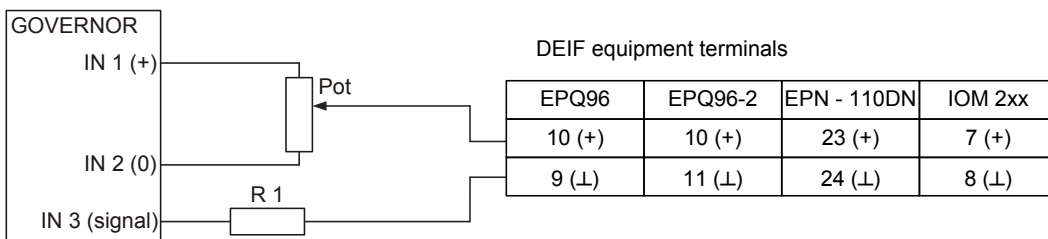

**INFO**

EPQ96-2 terminals 11-12 must be linked (connected together) to activate the internal 500 Ω shunt in order to create a voltage output.

DELOMATIC/PPU/GPC/AGC/BGC output is +/-20 mA, so a resistor is needed to convert into V DC range:

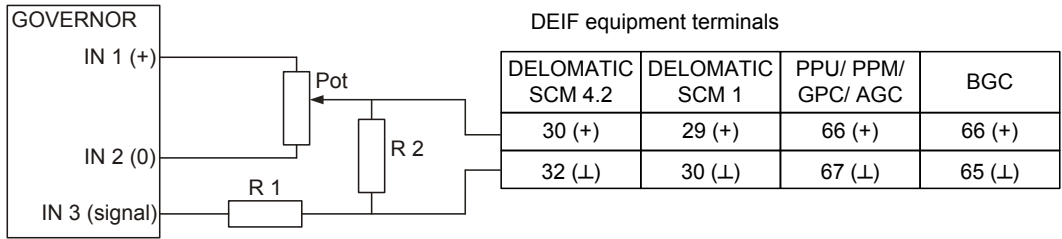

7. Governor interfaces



INFO

This chapter refers to the chapter 6 diagrams for terminals and resistor values unless otherwise stated.

7.1 Barber-Colman DYNA 1

DYNA I is intended for a potentiometer connected to terminal D (+8V DC), H (wiper) and F (+4V DC). When moving the wiper towards terminal D, the speed increases. Both direct and combined control circuits can be used:

Direct analogue control			
Input terminals		Resistor values	
IN 1	IN 2	R1	R2
H	F	499 k Ω	100 Ω

The combined analogue control uses terminal I instead of terminal F as reference.

Combined analogue controls					
Input terminals			Resistor values		
IN 1 (+)	IN 2 (0)	IN 3 (signal)	Pot	R1	R2
D	I	H	5 k Ω	499 k Ω	100 Ω

7.2 Barber-Colman DYNA DPG 2200 governor



INFO

The EPQ/EPN electronic potentiometers must be set to lowest range, +/-300 mV ~ +/-3 Hz.

Only direct analogue control is possible.

Direct analogue control			
Input terminals		Resistor values	
IN 1	IN 2	R1	R2
LS signal 9	LS ref (2.5 V) 10	0 Ω	15 Ω

7.3 Barber-Colman DYNA 8000 governor

DYNA 8000 is similar to DYNA I, i.e. it is intended for a remote potentiometer speed control - terminal 6 (+8V DC), 7 (+4V DC), 9 (wiper) and 10 (0 V). When moving the wiper towards 6, the speed increases.

Direct analogue control			
Input terminals		Resistor values	
IN 1	IN 2	R1	R2
9	7	0 Ω	220 Ω

The combined analogue control uses terminal I instead of terminal F as reference.

Combined analogue controls

Input terminals			Resistor values		
IN 1 (+)	IN 2 (0)	IN 3 (signal)	Pot	R1	R2
6	10	9	5 k Ω	0 Ω	220 Ω

7.4 Barber-Colman DYNA 1 digital controllers

7.4.1 Model DYN1 10502/3/4/6

Replace the remote speed potentiometer as follows:

Direct analogue control

Input terminals		Resistor values	
IN 1	IN 2	R1	R2
8	7	499 k Ω	100 Ω

7.4.2 Model DYN1 DYNA 2000

Replace the remote speed potentiometer as follows:

The input accepts 0...2V DC signals.

Direct analogue control

Input terminals		Resistor values	
IN 1	IN 2	R1	R2
9	7	0 Ω	100 Ω

7.4.3 Model DYN1 10871

There are 2 possibilities:

1. Use the speed increase (term. 15)/decrease (term. 16) binary inputs and relay outputs from the DEIF equipment. Inputs activate when connected to terminal 1 (+9...30V DC).
2. Replace the remote speed potentiometer.

The input is quite sensitive. Therefore the circuit is a bit special:

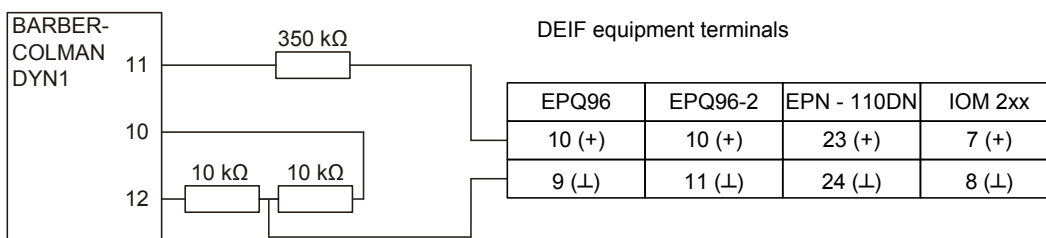

INFO

EPQ96-2 terminals 11-12 must be linked (connected together) to activate the internal 500 Ω shunt in order to create a voltage output.

DELOMATIC/PPU/GPC/AGC/BGC output is +/-20 mA, so a resistor is needed to convert into 2V DC range:

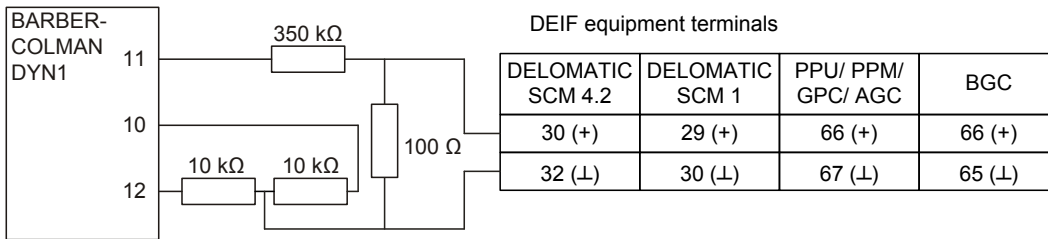

7.4.4 Model DYN1 10794

Replace the remote speed potentiometer as follows:

The input accepts 0...3.75V DC signals.

Direct analogue control			
Input terminals		Resistor values	
IN 1	IN 2	R1	R2
8	9	350 kΩ	200 Ω

7.5 Caterpillar® ADEM engine controller

The ADEM requires PWM signals for speed and droop settings. These can only be obtained with Multi-line 2 and EPQ96-2 units, all other DEIF units do not have this capability.

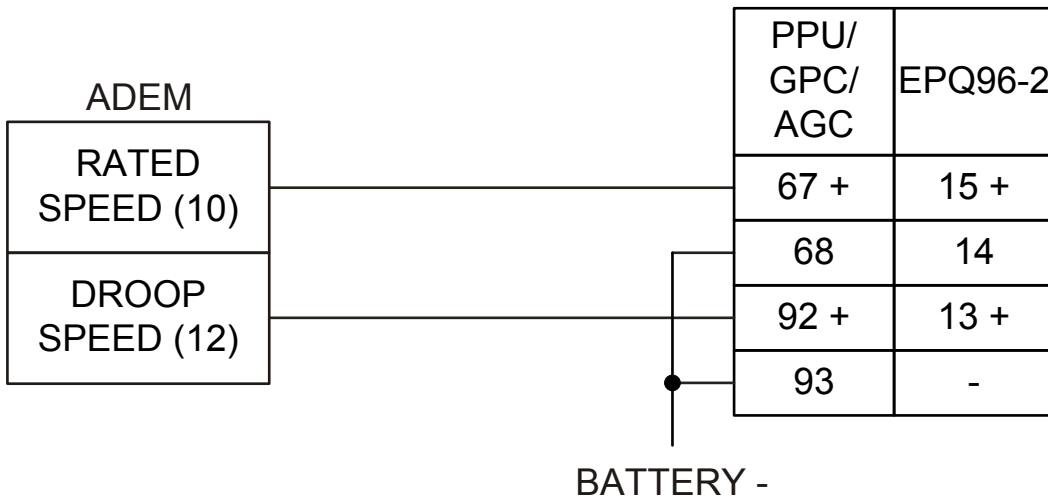

INFO
If DROOP is not needed, the connection can be removed.

INFO
Terminal numbers are plug numbers.

7.6 Caterpillar® PEEC engine controller

The PEEC requires PWM signals for speed and droop settings. These can only be obtained with Multi-line 2 and EPQ96-2 units, all other DEIF units do not have this capability.

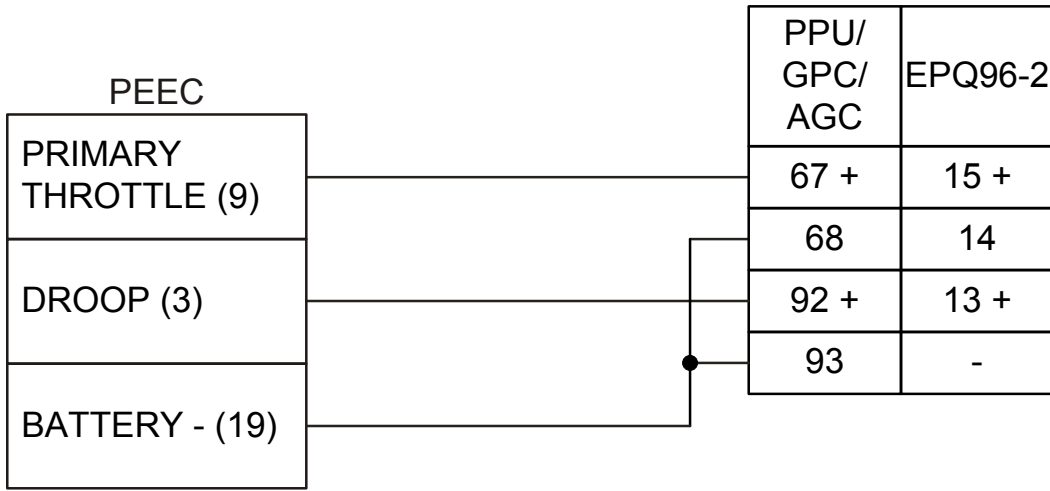

INFO
If DROOP is not needed, the connection can be removed.

INFO
Terminal numbers are plug numbers.

7.7 Caterpillar® Pulse Width Modulator converter

The CAT 9×9591 Pulse Width Modulator converter converts analogue signals into PWM signals for the ADEM and/or PEEC controllers, i.e. it must be used for controllers which do not have the PWM option.

Combined analogue controls					
Input terminals			Resistor values		
IN 1 (+)	IN 2 (0)	IN 3 (signal)	Pot	R1	R2
2	1	3	1kΩ	0Ω	250Ω

INFO
The polarity of the DEIF units' outputs must be reversed compared to the diagram in paragraph 6.

7.8 Cummins EFC governor

Cummins EFC governor accepts voltage signals directly, but the range is below the DEIF standard range. Therefore a voltage drop resistor (500 kΩ) is needed. In the following, two sets of terminals are shown. This is due to the fact that the EFC comes with two different terminal strip layouts.

Direct analogue control			
Input terminals		Resistor values	
IN 1	IN 2	R1	R2
10 (wiper)	11 (+4 V)	499 kΩ	120 Ω
8 (wiper)	9 (+4 V)		

7.9 Cummins ECM controller

Direct analogue control			
Input terminals		Resistor values	
IN 1	IN 2	R1	R2
23 (+)	14 (gnd)	0 Ω	200 Ω

**INFO**

The ECM gain must be set OFF.

**INFO**

The ECM must be set to Barber-Colman interface.

**INFO**

If screened cable is used, the screen must be connected to ECM terminal 19 only.

7.10 Cummins Power Command Control (PCC) load sharing system and Multi-line 2

Since the Multi-line 2 (ML-2) uses a 0...5V DC load sharing line, which is not compatible with the PCC load sharing line, a conversion must be made.

As the same problem occurs with other manufacturers' systems (Barber-Colman (BC)/Woodward/GAC), Cummins has made an interface unit called "Isochronous Load Sharing (ILSI) kit", Cummins part no. 300-5456, which is the one to be used for ML-2 connection to PCC.

The load sharing is for power load sharing only, kVAr load sharing must be made using different units.

Following the Cummins instruction sheet C-604 11-01, the procedure is as follows:

1. The 100% kW ML-2 load share line voltage is 5V DC.
2. Power up the ILSI module by applying 12-24V DC on TB2 terminals 5 (gnd) and 6 (+). Do not connect the load sharing lines yet.
3. Set the "Calibration Switch" to Cal.
4. Set the "ILS Type Switch" to BC.
5. Adjust the "Load Share Gain" potentiometer to 5V DC (measured on terminals TB1 1 (+) and 2 (-)).
6. Measure the "Calibration Voltage" on terminal TB2 5 (-) and "Calibration Voltage Test Point" (+). Typical value is 2.10V DC.
7. Adjust the "PCC Matching Potentiometer" until "PCC Voltage" is equal to "Calibration Voltage" in 6) (measured on terminals TB2 3 (+) and 4 (-)).
8. Move the "Calibration Switch" back to normal position.

It is important that the "Calibration Switch" is moved back to normal position before starting the generators. Failure to do this will provoke reverse power trips.

Load sharing lines diagram:

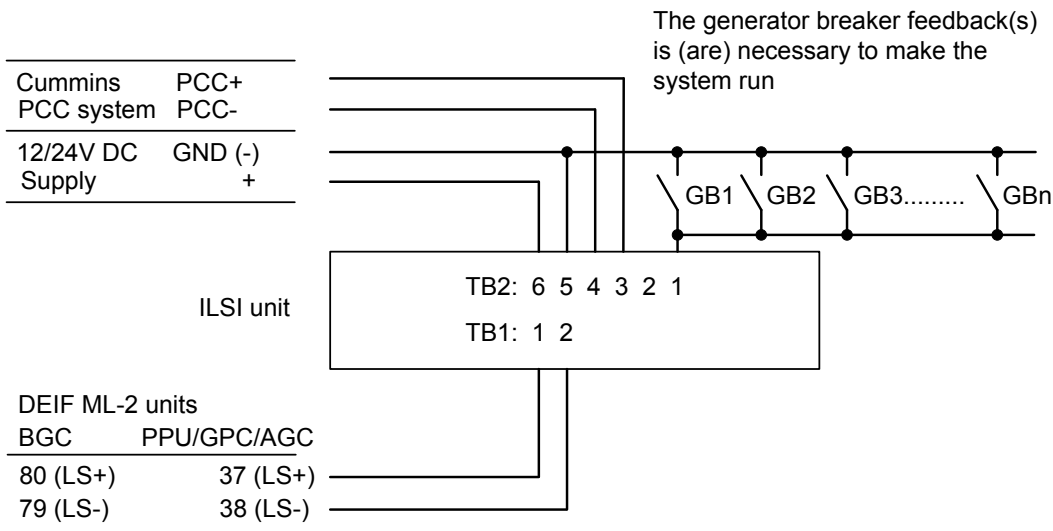

7.11 Detroit Diesel DDEC-III/DDEC-IV electronic governor

The DDEC accepts 0...5V DC signals directly:

Direct analogue control			
Input terminals		Resistor values	
IN 1	IN 2	R1	R2
D1 (speed)	C3 (ref)	0 Ω	250 Ω

Combined analogue controls					
Input terminals			Resistor values		
IN 1 (+)	IN 2 (0)	IN 3 (signal)	Pot	R1	R2
A3	C3 (ref)	D1 (speed)	5 kΩ	0 Ω	250 Ω

INFO
Terminals are referring to the 30 pole connector on the DDEC-III.

7.12 Deutz EMR electronic controller

The EMR accepts a 0.5...4.5V DC signal, but only half the range is needed, so 2V DC is sufficient:

Direct analogue control			
Input terminals		Resistor values	
IN 1	IN 2	R1	R2
24 (+)	23 (gnd)	0 Ω	100 Ω

INFO
A higher voltage range can be used (200 Ω to give 4V DC). In this case the EMR frequency setting must be checked to be 49-51 Hz.

7.13 GAC type ESD 5111, 5221 and 5131

This GAC range has a terminal for external equipment. This terminal accepts +/-5V DC signals, so most of the DEIF controllers can be connected directly.

Direct analogue control			
Input terminals		Resistor values	
IN 1	IN 2	R1	R2
G (gnd)	N (input)	0 Ω	250 Ω

7.13.1 Combined analogue control

For EPQ and EPN the output range must be set to 1.3V DC:

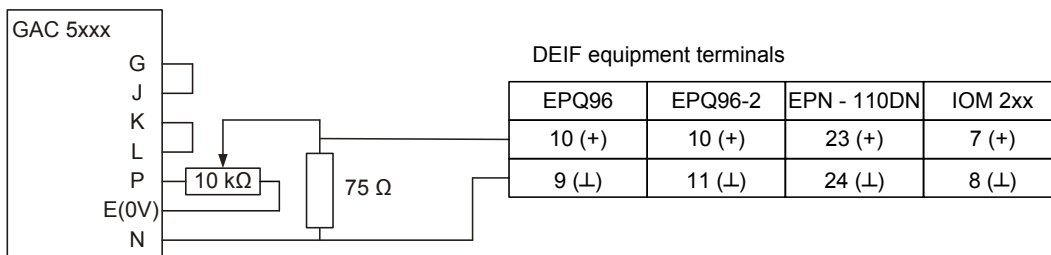

INFO

EPQ96-2 terminals 11-12 must be linked (connected together) to activate the internal 500 Ω shunt in order to create a voltage output.

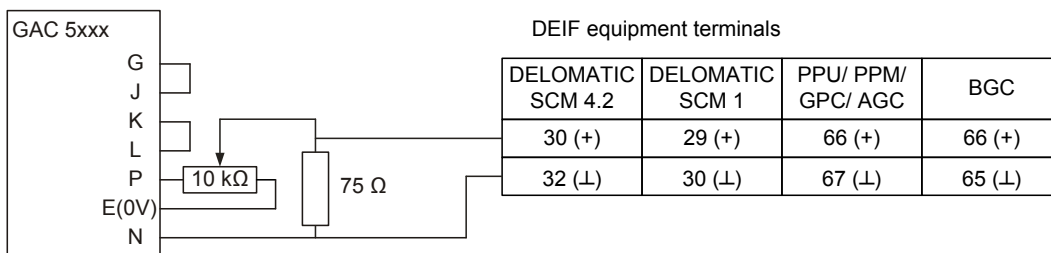

7.14 GAC type ESD 5300 and 5330

The ESD 5330 has an input for 0...10V DC control as follows:

Direct analogue control			
Input terminals		Resistor values	
IN 1	IN 2	R1	R2
G (gnd)	M (aux.)	0 Ω	500 Ω

7.15 GAC type ESD 5500

The output signal from EPQ/EPN must be set to give +2.5 V after power up.

For EPQ/EPN the "up" input will result in a decreasing speed, and the "down" input will result in an increasing speed.

For Delomatic/Multi-line the output signal must be set to give -10.0 mA on power up. Since the connections are reversed, the ESD 5500 will see a +2.5V DC across the 250 Ω resistor, and increase/decrease will work properly.

**INFO**

On the ESD 5500, terminal J can be used instead of N. The J input has a lower impedance (5 kΩ) than N (1 MΩ). The G terminal on the ESD 5500 is connected to battery -.

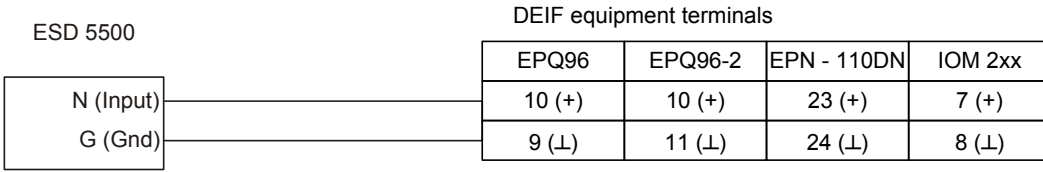
**INFO**

EPQ96-2 terminals 11-12 must be linked (connected together) to activate the internal 500 Ω shunt in order to create a voltage output.

DELOMATIC/PPU/GPC/AGC/BGC output is +/-20 mA, so a resistor is needed to convert into 10V DC range:

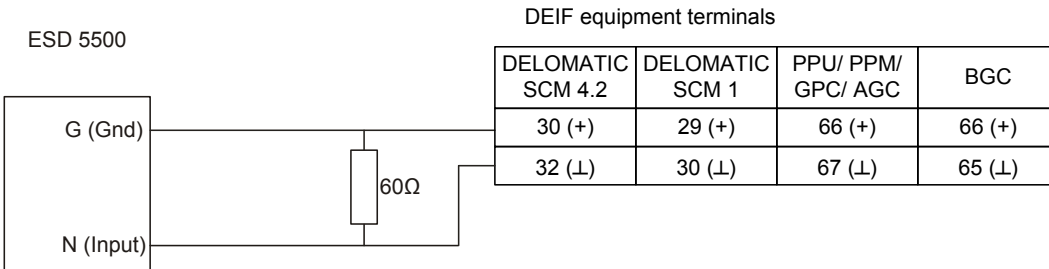

7.15.1 Combined analogue control

For EPQ, EPN and IOM 2xx, the output range must be set to 1.3V DC:

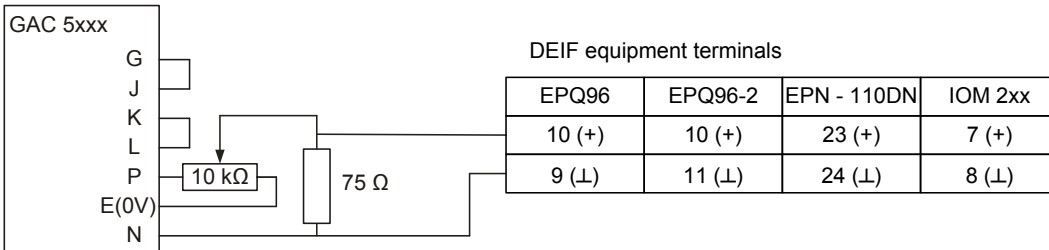
**INFO**

EPQ96-2 terminals 11-12 must be linked (connected together) to activate the internal 500 Ω shunt in order to create a voltage output.

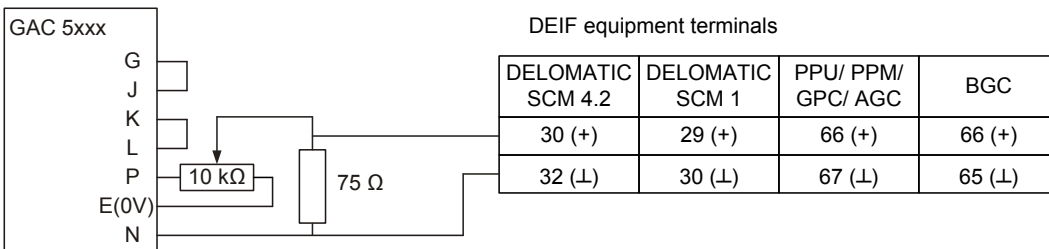

7.16 Heinzmann type E1-D and E1-F speed governor

Type E1-D/F accepts control voltage signals (0-5V DC) directly on terminal 3 (-) and 4 (+), so most of the DEIF controllers can be connected directly.

**INFO**

The signal must be protected by a diode as shown in order to prevent malfunction of the system.

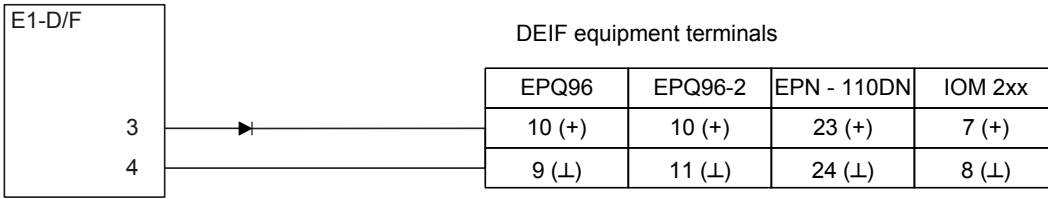
**INFO**

EPQ96-2 terminals 11-12 must be linked (connected together) to activate the internal 500 Ω shunt in order to create a voltage output.

DELOMATIC/PPU/GPC/AGC/BGC output is +/-20 mA, so a resistor is needed to convert into 5V DC range:

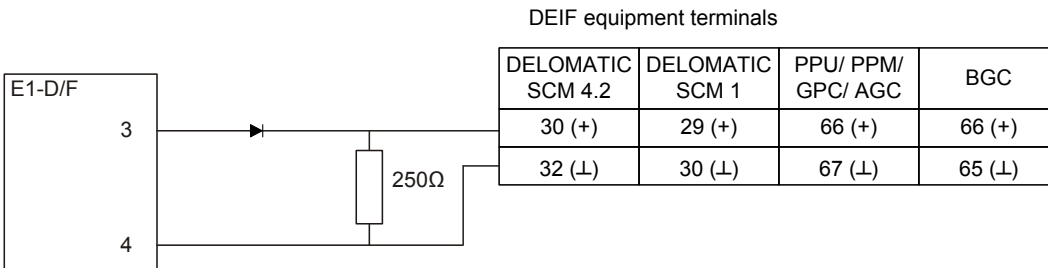

7.17 Heinzmann type E6, E6V, E10, E16 and E30 speed governor

The E6...E30 series is intended for a 5K speed trim potentiometer. The DEIF equipment giving a voltage output can be connected in series with the wiper of the potentiometer:

Combined analogue controls					
Input terminals			Resistor values		
IN 1 (+)	IN 2 (0)	IN 3 (signal)	Pot	R1	R2
A	C	B (In)	5 kΩ	0 Ω	250 Ω

7.18 Heinzmann Olympus for gas turbines

Heinzmann Olympus accepts binary (relay) control signals as follows:

- Raise speed: Connect terminal H (connector 2) to +24V DC supply.
- Lower speed: Connect terminal S (connector 2) to +24V DC supply.

7.19 Heinzmann KG 6 - 04 to KG10 - 04

The Heinzmann KG series accepts voltage signals (1...5V DC) directly connected:

Direct analogue control			
Input terminals		Resistor values	
IN 1	IN 2	R1	R2
C3	A3	0 Ω	250 Ω

7.20 MTU MDEC 4000 controller

The MDEC 4000 controller accepts both binary and analogue inputs.

Binary inputs are optocoupler inputs requiring 24V DC as follows:

Speed raise: X1-EE (cable wire 4) to gnd, X1-FF (cable wire 3) to +24V DC.

Speed lower: X1-u (cable wire 14) to gnd, X1-v (cable wire 13) to +24V DC.

Direct analogue control			
Input terminals		Resistor values	
IN 1	IN 2	R1	R2
8	36	0 Ω	500 Ω



INFO

Set the Multi-line analogue governor offset to 50% to compensate the MTU speed internal offset.

7.21 Perkins type ECM controller

The Perkins ECM accepts binary signals for speed control:

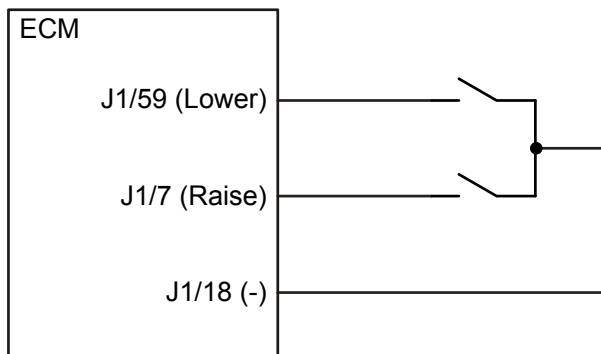

The ECM terminal numbers refer to the ECM module connectors. The equivalent Customer interface connector P3 connectors are:

ECM	P3
J1/59	29
J1/7	28
J1/18	12

7.22 SCANIA type DEC2 controller

The DEC2 accepts 0...3V DC input for 0...100% speed, max. 5V DC to avoid damage, so the DEIF equipment can be connected directly.



INFO

The electronic potentiometers must have the range 5V DC.

Direct analogue control

Input terminals		Resistor values	
IN 1	IN 2	R1	R2
B8	A7	0 Ω	200 Ω

7.23 TOHO electronic governor speed controller XS-400B-03

The TOHO speed controller accepts voltage signals and therefore DEIF equipment can be connected directly. NOTE: As the TOHO unit operates at 4V DC as base setting, the initial adjustment must be carried out with the DEIF equipment connected and powered up, but set at 0 V (0 mA for Delomatic/PPU/GPC) output.

Direct analogue control

Input terminals		Resistor values	
IN 1	IN 2	R1	R2
1	-S	0 Ω	200 Ω

7.24 Volvo type EMS2 controller

Volvo type EMS2 controller accepts 1.0 to 4.7V DC signals only, with an active range of 2.85V DC. In order to meet these requirements, the following network must be made:



INFO

The diodes are to prevent negative signals to the EMS2 which it cannot accept.



INFO

Set EPQ/EPN output range to 3V DC.

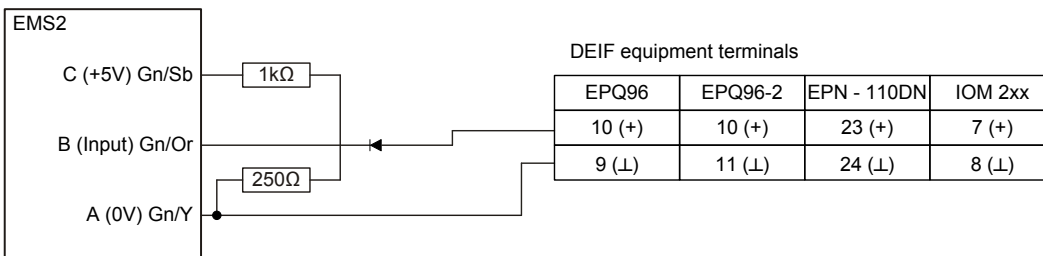

INFO

EPQ96-2 terminals 11-12 must be linked (connected together) to activate the internal 500 Ω shunt in order to create a voltage output.

DELOMATIC/PPU/GPC/AGC/BGC output is +/-20 mA, so a resistor circuit is needed to convert into 2.85V DC range:

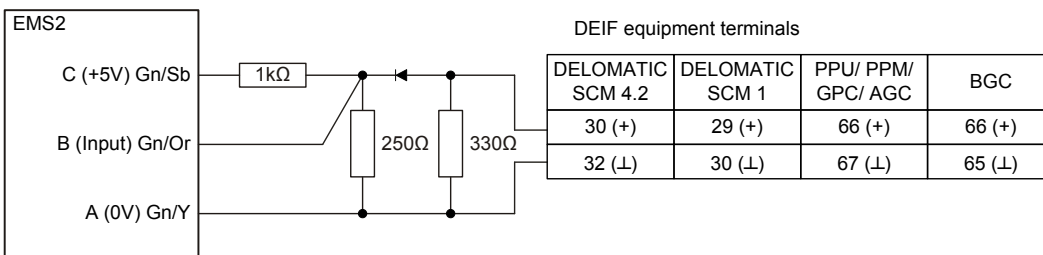

Abbreviations for wire colours on EMS2: Gn/Sb: Green/black, Gn/Or: Green/orange, Gn/Y: Green/yellow.

7.25 Woodward type 1724 and 1712 governor

Woodward 17xx accepts voltage signals (+/-5V DC) directly on terminal 7 (+) and 8 (-), so the DEIF controllers can be connected directly:

Direct analogue control			
Input terminals		Resistor values	
IN 1	IN 2	R1	R2
7 (+)	8 (-)	0 Ω	250 Ω

7.26 Woodward type 2301A speed control governor

Woodward 2301A speed control voltage signals (+/-5V DC) directly on terminal 17 (-) and 15 (+), so the DEIF controllers can be connected directly:

Direct analogue control			
Input terminals		Resistor values	
IN 1	IN 2	R1	R2
15 (+)	17 (-)	0 Ω	250 Ω

7.27 Woodward type 2301A load sharing

Woodward 2301A load sharing is intended for a 100 Ω potentiometer for external speed control.

For DEIF equipment with voltage output:

Direct analogue control			
Input terminals		Resistor values	
IN 1	IN 2	R1	R2
24 (+)	23 (-)	0 Ω	140 Ω

7.28 Woodward type 701A

The type 701A can accept both analogue and binary signals for speed control.

For DEIF equipment with voltage output:

Direct analogue control			
Input terminals		Resistor values	
IN 1	IN 2	R1	R2
21 (+)	22 (-)	0 Ω	140 Ω

Binary signals:

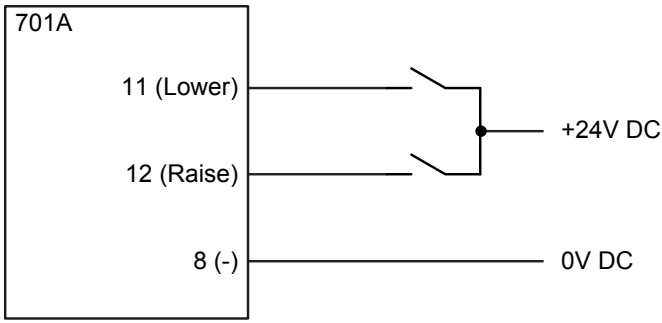

7.29 Woodward 721 digital speed control

Even though the unit accepts analogue signals, we recommend using the binary input terminal 27 (lower speed) and 28 (raise speed). The inputs are activated when connected to terminal 1 (+).

7.30 Woodward generator load sensor

The Woodward generator load sensor (using a Pulse Width Modulated signal for the governor) is intended for a 3-pole potentiometer.

Due to the internal circuits, the standard DEIF way of doing the connections cannot be used. Instead of connecting the outputs from the DEIF units to one side of the potentiometer and the wiper input, connections must be made for ground and wiper. Because of this the usual way of initial setting by switching off the DEIF unit during initial governor adjustment cannot be used. The DEIF unit must be switched ON and the output adjusted to 0V DC when adjusting the governor. After this, the normal procedure can be carried out. Please also note that the output is "inverted"; connect the + output from the DEIF unit to the gnd on the load sensor. This is possible due to the fact that the DEIF unit's output is galvanically separated from the rest of the unit.

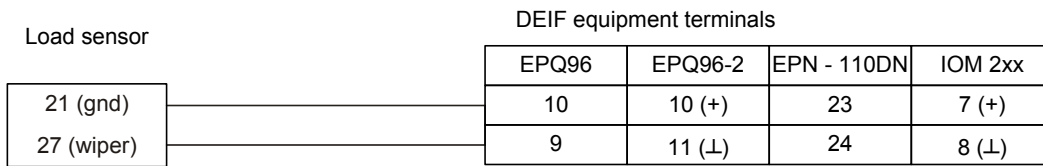

INFO

EPQ96-2 terminals 11-12 must be linked (connected together) to activate the internal 500 Ω shunt in order to create a voltage output.

An alternative solution is to use the SPM-A synchroniser input:



INFO

The load sensor terminals 13-14 connection must remain open. Do not close with the generator breaker, as that will make the load sensor ignore the SPM-A input.

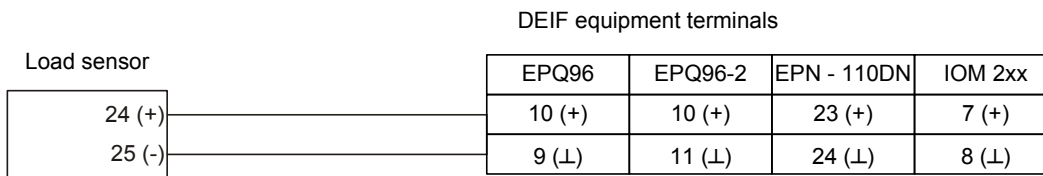

INFO

EPQ96-2 terminals 11-12 must be linked (connected together) to activate the internal 500 Ω shunt in order to create a voltage output.

**INFO**

The load sensor inputs accept +/-3V DC. The DEIF units must have the output adjusted accordingly.

DELOMATIC/PPU/GPC/AGC/BGC output is +/-20 mA, so a resistor is needed to convert into 10V DC range:

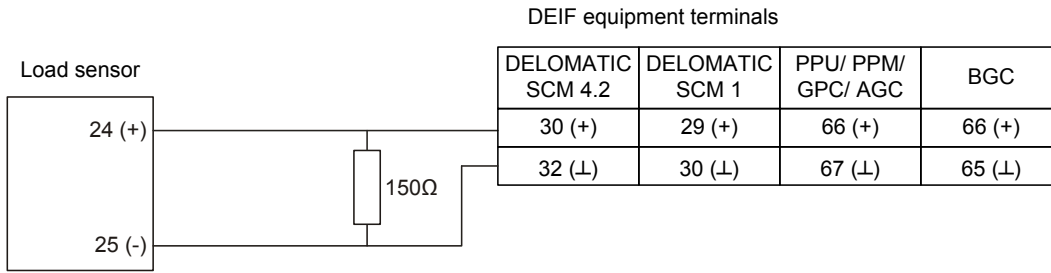

7.31 Woodward L-series governor

The L-series analogue input AUX #1 is especially designed for speed setting input, 0-5V DC, which is recommended.

The input can be configured to +/-3V DC as well. Refer to Woodward for details.

This configuration is for 0-5V DC input:

Direct analogue control			
Input terminals		Resistor values	
IN 1	IN 2	R1	R2
8 (+)	3 (-)	0 Ω	250 Ω

7.32 Woodward ProAct digital speed control system type I and II

The ProAct analogue input AUX is especially designed for speed setting input, +/-3V DC.

Direct analogue control			
Input terminals (TB2)		Resistor values	
IN 1	IN 2	R1	R2
12 (+)	13 (-)	0 Ω	150 Ω

7.33 Woodward PEAKTM 150 digital control for steam turbines

The unit accepts relay (discrete) inputs. Binary input 12 (lower speed) and 13 (raise speed). Internally powered (jumper 15 set, see manual), the inputs are activated when connecting terminal 33 (+24V DC internal source) to the input in question (12 or 13). Externally powered (jumper 16 set, see manual), the external negative (-) is to be connected to terminal 20, and the inputs (12 or 13) are then activated when the external +24V DC is connected to them.

7.34 Woodward UG8 digital control

The UG8 digital control accepts 4...20 mA input for speed control. This means that a standard electronic potentiometer cannot be used directly, as it is giving a voltage output.

The electronic potentiometers can be changed into giving 0-20 mA outputs, but this is a special version that has to be asked for. The Delomatic/PPU/GPC/AGC/BGC can connect directly:

UG 8
Digital

9 (+)

10 (-)

DEIF equipment terminals

SPECIAL EPQ96	EPQ96-2	IOM 2xx	SPECIAL EPN - 110DN	DELOMATIC SCM 4.2	DELOMATIC SCM 1	PPU/ PPM/ GPC/ AGC	BGC
10 (+)	10 (+)	7 (+)	23 (+)	30 (+)	29 (+)	66 (+)	66 (+)
9 (⊥)	11 (⊥)	8 (⊥)	24 (⊥)	32 (⊥)	30 (⊥)	67 (⊥)	65 (⊥)



INFO

EPQ96/EPN must be modified for current output. EPQ96-2 standard can be used.

8. CANbus engine controller interface



INFO

The following contains information of CANbus connections for various electronic Engine Controller Units (ECUs). For information about the signals that can be received/transmitted, please see the Option H5/H7/H13 manual.

8.1 CANbus interface

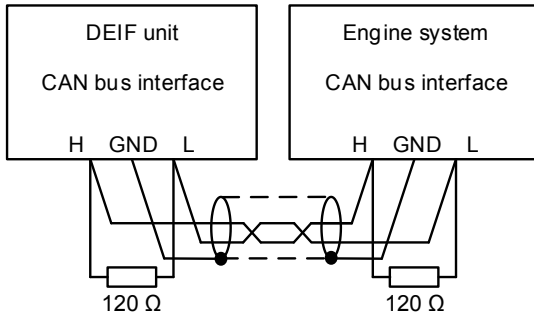

INFO

2 x 120 Ohm end terminal resistors are always needed. Note that some engine systems have the resistor incorporated. Refer to the engine controller installation manual for details.



INFO

Use twisted pair cable, 1 mm² (16 AWG). If screened cable is used, connect one end to earth (ground) and isolate the other end. Do not connect screen to the DEIF or the engine unit.

8.2 DEIF unit terminals

AGC Option H13	AGC/GPU/GPC/PPU/PPM Option H5/H13	AGC/GPU/GPC/PPU/PPM Option H7	AGC 200	BGC Option H5	GC-1F Option H5	GC-1/EC-1 Option H5
130 (CAN-H)	130 (CAN-H)	A1 (CAN-H)	13 (CAN-H)	47 or 55 (CAN-H)	53 (CAN-H)	1 (CAN-H)
128 (CAN-L)	128 (CAN-L)	A3 (CAN-L)	15 (CAN-L)	49 or 57 (CAN-L)	55 (CAN-L)	3 (CAN-L)

8.3 CANbus J1939 engine unit terminals

Engine controller	Connector	Terminals	Remark
Caterpillar ADEM A4	Customer harness J1/P1	17 (CAN-H)	
		18 (CAN-L)	
Cummins QSK 50/60 engine	J1939 backbone	A (CAN-H)	Built-in 120 Ω end resistor
		B (CAN-L)	
Cummins QSB 5/7 and QSL 9 engine	50 pin OEM connector	46 (CAN-H)	
		47 (CAN-L)	
Deutz EMR 2	Plug F	12 (CAN-H)	
		13 (CAN-L)	
Deutz EMR 3	Diagnostic plug X22	M (CAN-H)	
		F (CAN-L)	

Engine controller	Connector	Terminals	Remark
Iveco Vector engines	Engine harness	255 (CAN-H)	
		256 (CAN-L)	
Perkins ECM	Connector P3	31 (CAN-H)	Terminals 2 (digital control enable) and 12 (digital ground) on connector P3 must be connected if speed setting signals are to be transmitted via J1939
		32 (CAN-L)	
Scania EMS-S6	Connector B1	9 (CAN-H)	Built-in 120 Ω end resistor
		10 (CAN-L)	
Volvo Penta EMS 2	8-pole Deutsch connector receptacle	1 (CAN-H)	
		2 (CAN-L)	

8.4 MTU terminals

Engine controller	Connector	Terminals	Remark
ADEC CANopen protocol	SAM module X23	6 (CAN-H)	Option H5 or H13 is required Built-in 120 Ω end resistor
		5 (CAN-L)	
ADEC J1939 (smart connect)	Smart connect X3	1 (CAN-H)	Option H5 or H13 is required Built-in 120 Ω end resistor
		2 (CAN-L)	
ADEC M501 MTU protocol	ECU7 X1	19 (CAN1-H)	Option H13 is required Built-in 120 Ω end resistor
		35 (CAN1-L)	
MDEC	ECU X1	G (CAN-H)	Option H5 or H13 is required MTU protocol
		F (CAN-L)	



INFO

Option H7 cannot be used for MTU MDEC/ADEC module 501 interface.

MTU ADEC requires SAM module.

The MTU MDEC uses an MTU protocol.



INFO

MTU ADEC, SAM module: Parameters PR500, PR501 and PR533 must be set correctly to obtain speed control.

Normal selection: PR500=0, PR501=0, PR533=1.



INFO

MTU ADEC, SAM module: Parameter PR2.1060.150 must be set to "ANALOG CAN" to obtain speed control.



INFO

The above settings for SAM module and ADEC are for guidance only. Values may vary between different models.

8.5 Huegli Tech HT-SG-100 speed governor

The HT-SG-100 is a digital speed governor for smaller engines (max. 6 A drive output) which interfaces via J1939. It works with all DEIF J1939 options.

Controller	Connector	Terminals	Remark
HT-SG-100	Bottom	P (CAN-L)	External end resistor is needed
		Q (CAN-H)	



INFO

Select engine controller/type "Generic J1939" in setting 7651.

9. AVR interface basic circuits



INFO

The following contains indications of resistor values. These values are for guidance only, and you may have to change the resistors to obtain proper control. Generally, choosing too big resistors across the +/-20 mA outputs from DEIF units will result in unstable control; choosing too small resistors will result in the system being unable to control the generator in the full operating range (maintaining voltage in the 0-100% load range).

9.1 Direct analogue controls

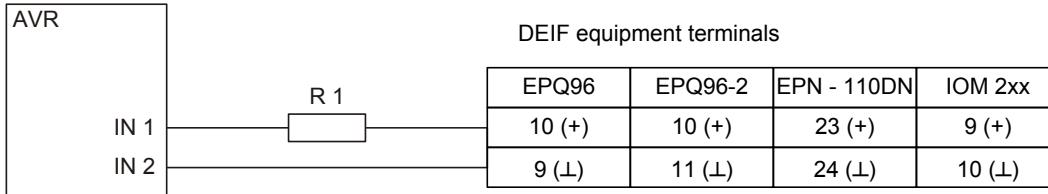

INFO

EPQ96-2 terminals 11-12 must be linked (connected together) to activate the internal 500 Ω shunt in order to create a voltage output.

DELOMATIC/PPU/GPC/AGC/BGC output is +/-20 mA, so a resistor is needed to convert into V DC range:

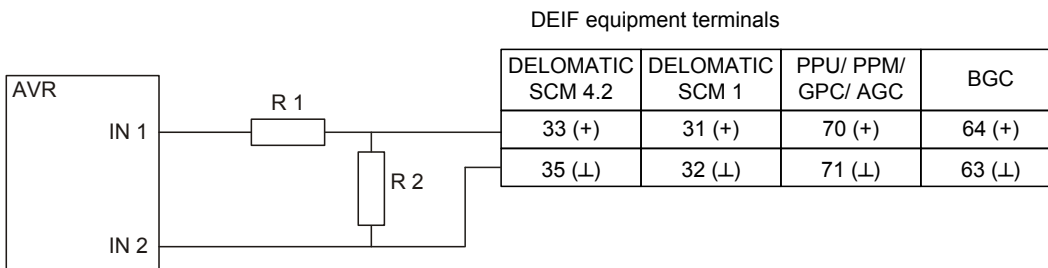

9.2 Combined analogue controls, 3-wire

The combined analogue control uses the combination of the DEIF unit's analogue output and a speed setting potentiometer.

The advantage of this solution is the possibility to do basic speed settings with the potentiometer and thereafter let the DEIF unit take over.



INFO

If the potentiometer is only used for initial adjustments, it can be replaced by fixed resistors once the adjustment is done.

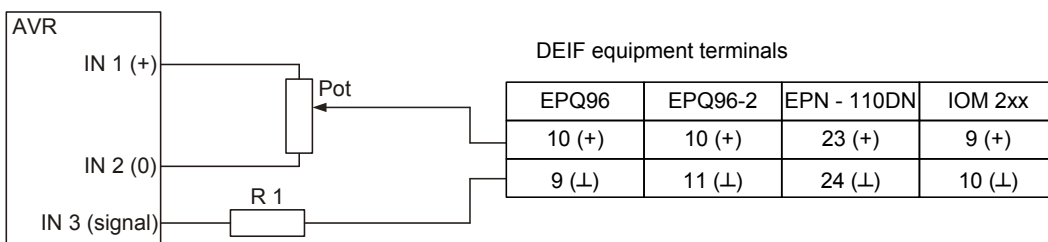

INFO

EPQ96-2 terminals 11-12 must be linked (connected together) to activate the internal 500 Ω shunt in order to create a voltage output.

DELOMATIC/PPU/GPC/AGC/BGC output is +/-20 mA, so a resistor is needed to convert into V DC range:

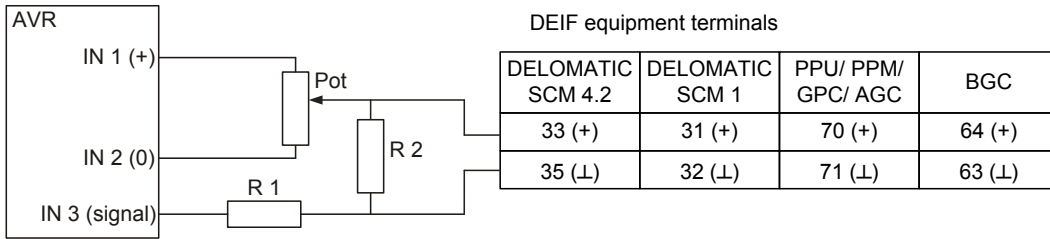

9.3 Combined analogue controls, 2-wire

The combined analogue control uses the combination of the DEIF unit's analogue output and a speed setting potentiometer.

The advantage of this solution is the possibility to do basic speed settings with the potentiometer and thereafter let the DEIF unit take over.



INFO

If the potentiometer is only used for initial adjustments, it can be replaced by fixed resistors once the adjustment is done.

The connection to DEIF equipment is as follows:

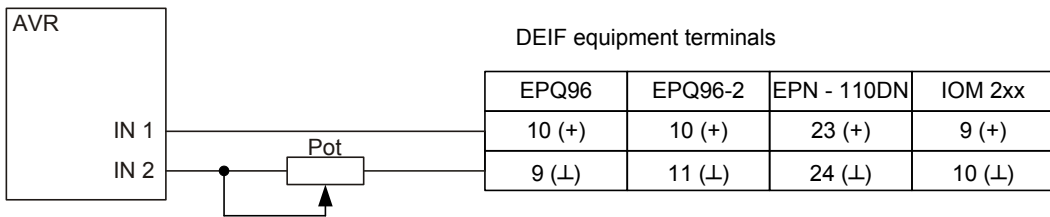

INFO

EPQ96-2 terminals 11-12 must be linked (connected together) to activate the internal 500 Ω shunt in order to create a voltage output.

DELOMATIC/PPU/GPC/AGC/BGC output is +/-20 mA, so a resistor is needed to convert into 3V DC range:

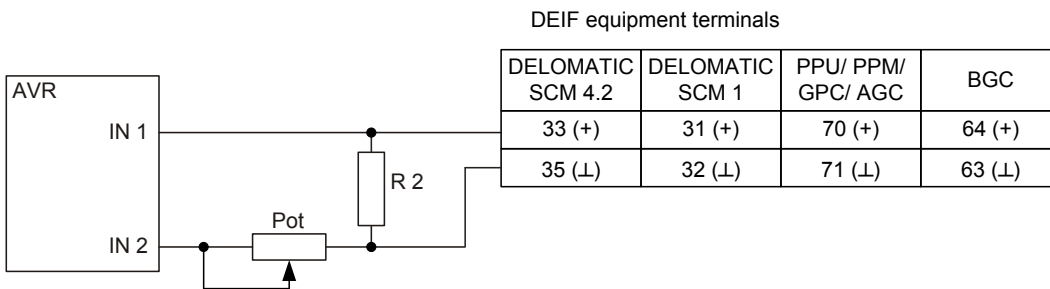

10. AVR interfaces



INFO

This chapter refers to the chapter 8 diagrams for terminals and resistor values unless otherwise stated.

10.1 AVK Cosimat AVR

This applies for all types of the AVK COSIMAT:

The COSIMAT has an auxiliary input for external equipment, which accepts 0...10V DC signals. As the input only accepts positive signals, a diode is needed to prevent negative signals:

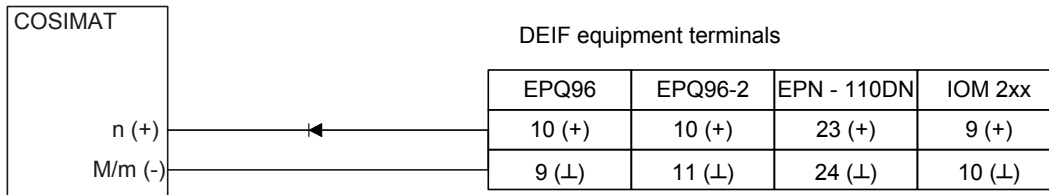

INFO

EPQ96-2 terminals 11-12 must be linked (connected together) to activate the internal 500 Ω shunt in order to create a voltage output.

DELOMATIC/PPU/GPC/AGC/BGC output is +/-20 mA, so a resistor is needed to convert into 10V DC range:

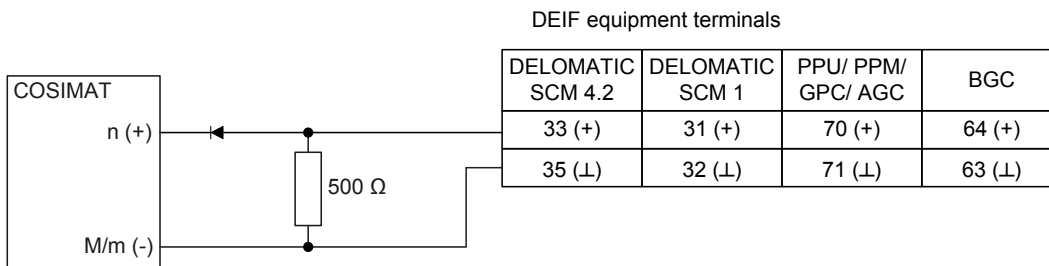

Adjustment:

- The R4 potmeter in the COSIMAT (18-turn) must be adjusted to "min."
- Use manual control to raise the DEIF equipment to +10V DC.
- Start the generator and use R4 to set the max. allowable voltage.
- Adjust the integration time of the DEIF equipment if needed.

10.2 Basler Electric AEC63-7 AVR

Direct analogue control

Input terminals		Resistor values	
IN 1	IN 2	R1	R2
7 (+)	6	0 Ω	80 Ω

Voltage droop set to 4%.

10.3 Basler Electric digital excitation control system (DECS)

The DECS accepts binary inputs directly on terminals 6D (lower voltage), 7 (common) and 6U (increase voltage).

To increase voltage: Connect 6U to 7.

To decrease voltage: Connect 6D to 7.

Also analogue signals can be used (+/-10V DC or 4-20 mA range):

Direct analogue control			
Input terminals		Resistor values for the +/-10V DC range	
IN 1	IN 2	R1	R2
A (+)	B	0 Ω	150 Ω

10.4 Basler Electric SR 4A/6A/8A/9A/32A AVR

The Basler SR series is intended for a 2-wire 175 Ω potentiometer input.

The connection to DEIF equipment is as follows:

Combined analogue control, 2-wire			
Input terminals		Resistor values	
IN 1	IN 2	Pot	R2
7 (+)	6	175 Ω	150 Ω

10.5 Basler Electric SSR 32-12, 63-12, 125-12 AVR

The SSR series works in an "inversed" way, meaning that the standard DEIF way cannot be used.

The input used is the "ext. adj.".

The diode mounted in the connection prevents positive voltages from being sent to the SSR unit. As both EPQ/EPN and Delomatic/PPU/GPC/AGC/BGC are using bipolar galvanically separated outputs, this is not a problem.

When adjusting the generator voltage initially, adjust the (internal) idle voltage to 25% above nominal. The DEIF units will then bring the voltage down to nominal level when activated:

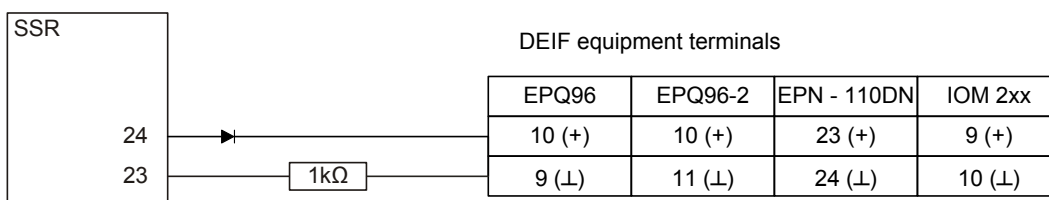

INFO

EPQ96-2 terminals 11-12 must be linked (connected together) to activate the internal 500 Ω shunt in order to create a voltage output.

DELOMATIC/PPU/GPC/AGC/BGC output is +/-20 mA, so a resistor is needed to convert into 5V DC range:

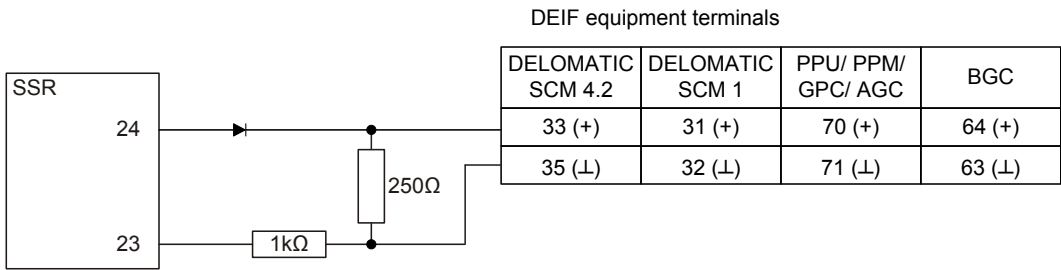

10.6 Caterpillar® VR3

Set the EPQ/EPN output to +/-5V DC.

The 100 Ω resistor is there to dampen the signal.

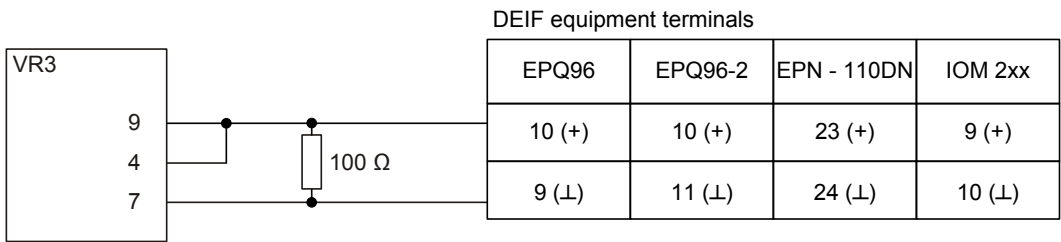

INFO

EPQ96-2 terminals 11-12 must be linked (connected together) to activate the internal 500 Ω shunt in order to create a voltage output.

DELOMATIC/PPU/GPC/AGC/BGC output is +/-20 mA, so a resistor is needed to convert into 1V DC range:

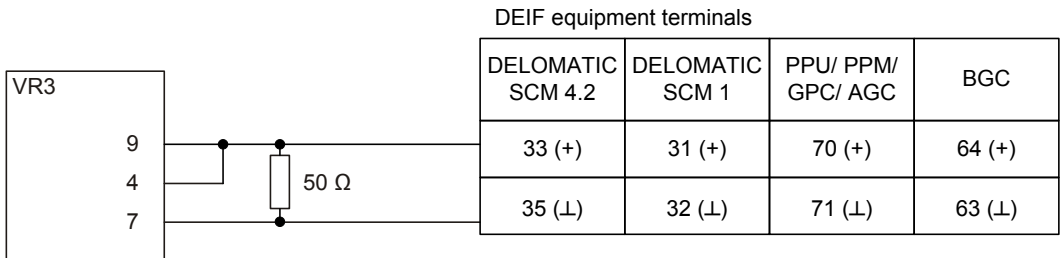

10.7 Caterpillar® VR6

Set the EPQ/EPN output to +/-5V DC.

The 100 Ω resistor is there to dampen the signal.

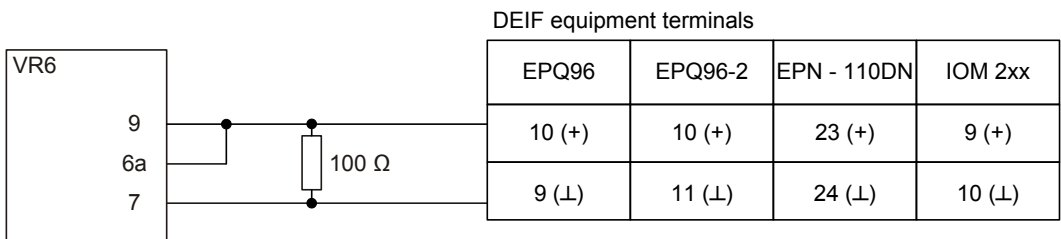

INFO

EPQ96-2 terminals 11-12 must be linked (connected together) to activate the internal 500 Ω shunt in order to create a voltage output.

DELOMATIC/PPU/GPC/AGC/BGC output is +/-20 mA, so a resistor is needed to convert into 1V DC range:

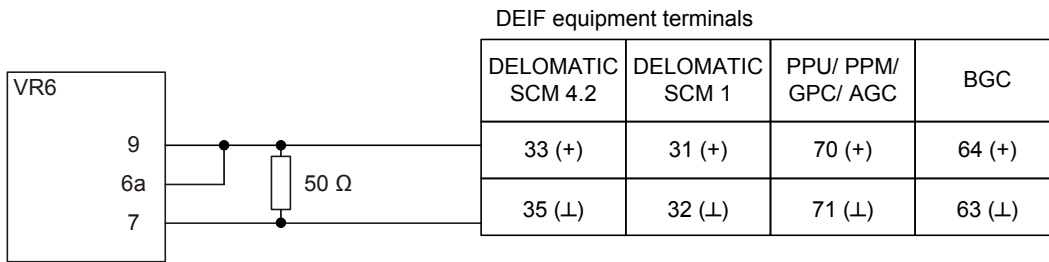

10.8 Caterpillar® DVR

The DVR 2-wire input gives an increasing generator voltage with increasing resistance.

Set the EPQ/EPN output to +/-5V DC.

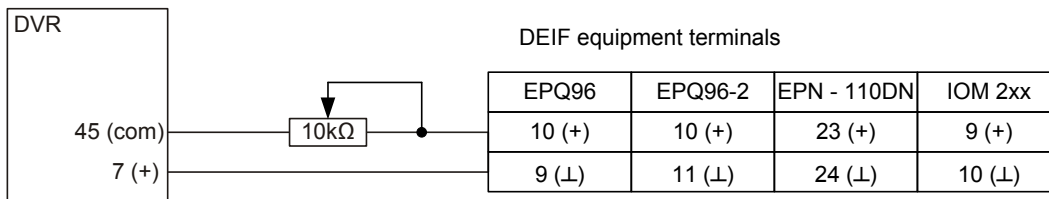

INFO

EPQ96-2 terminals 11-12 must be linked (connected together) to activate the internal 500 Ω shunt in order to create a voltage output.

DELOMATIC/PPU/GPC/AGC/BGC output is +/-20 mA, so a resistor is needed to convert into 5V DC range:

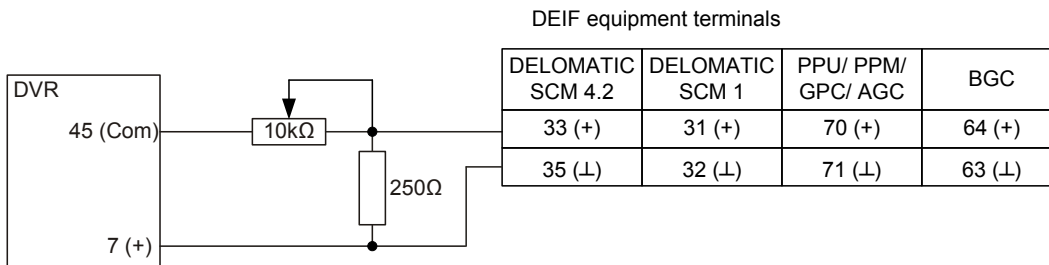

10.9 Caterpillar® CDVR

The CDVR accepts binary inputs for voltage up/down control or analogue signals.

Binary inputs:

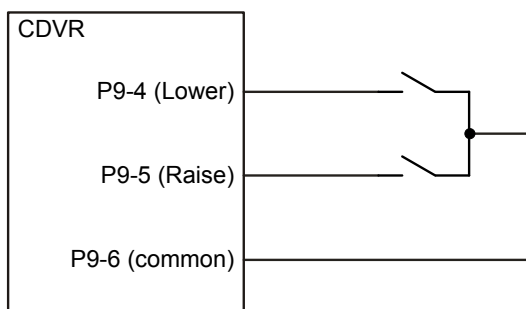

Direct analogue control

Input terminals		Resistor values	
IN 1	IN 2	R1	R2
P12-6	P12-3	0 Ω	500 Ω

10.10 Leroy Somer type R250/R438/R448/R449 LS/C or D AVR

The type R250/R438/R448/R449 does not have a terminal strip, but uses automotive spade connectors.

As the external control is 2-wire potentiometer, the following circuit must be used:

Circuit as described by Leroy Somer:

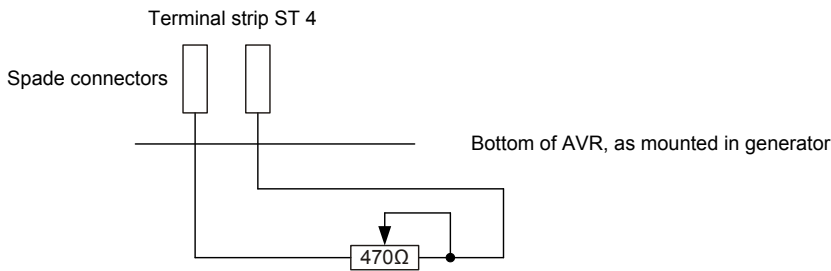

Using DEIF equipment:

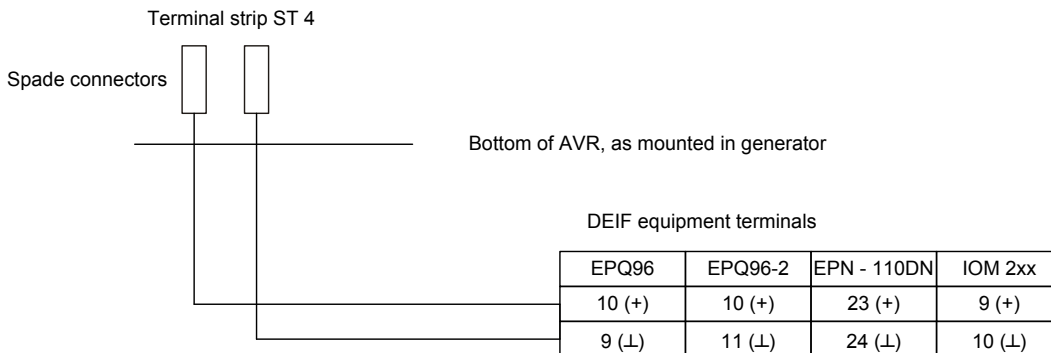

INFO

EPQ96-2 terminals 11-12 must be linked (connected together) to activate the internal 500 Ω shunt in order to create a voltage output.

The output from the electronic potentiometer is set to 1V DC.

DELOMATIC/PPU/GPC/AGC/BGC output is +/-20 mA, so a resistor is needed to convert into 1V DC range:

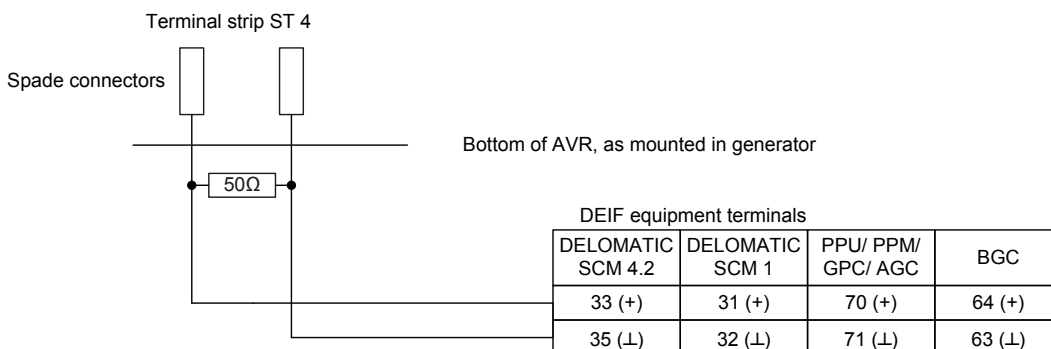

10.11 Leroy Somer type R450 AVR

The type R450 does not have a terminal strip but uses automotive spade connectors.

As the external control is a 2-wire potentiometer, the following circuit must be used:

Circuit as described by Leroy Somer:

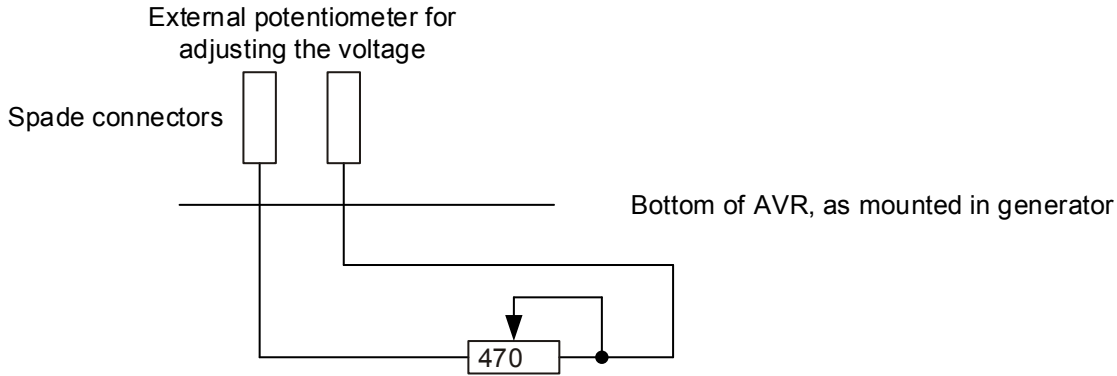

Using DEIF equipment:

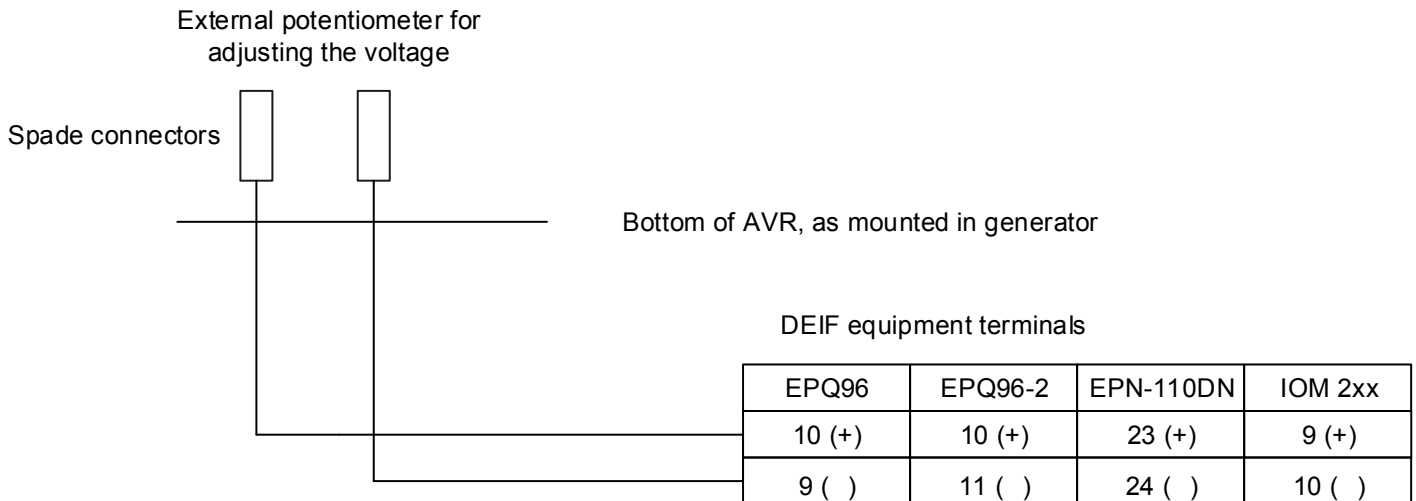

INFO

EPQ96-2 terminals 11-12 must be linked (connected together) to activate the internal 500 Ω shunt in order to create a voltage output.

The output from the electronic potentiometer is set to 1 V DC.

DELOMATIC/PPU/GPC/AGC/BGC output is +/-20 mA, so a resistor is needed to convert into 2 V DC range:

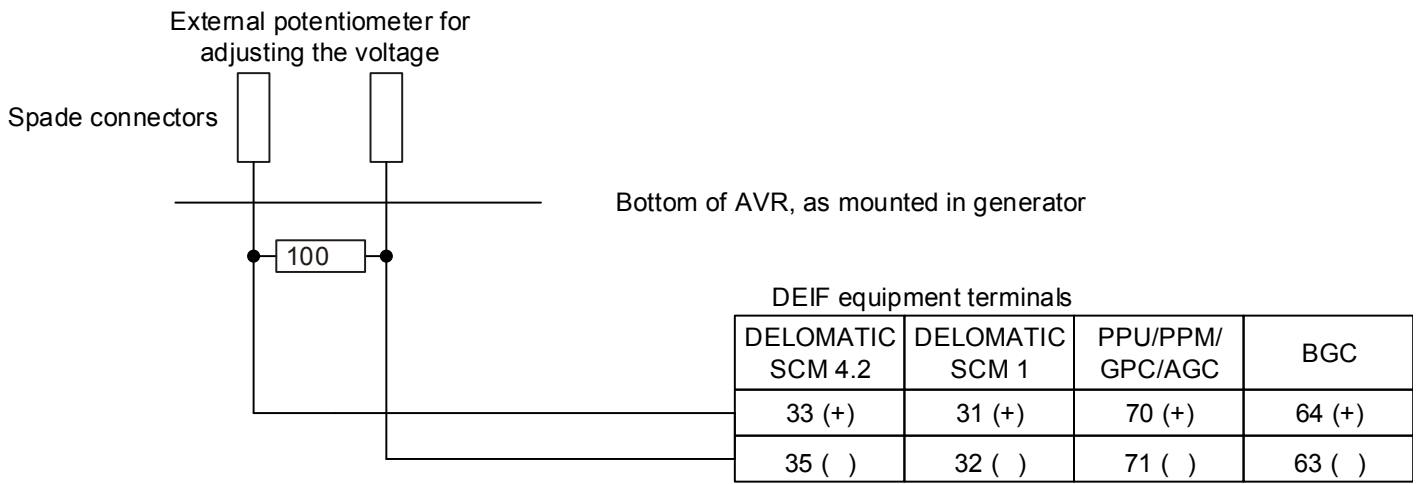

10.12 Leroy Somer type R610 AVR

As a standard, R610 is not equipped with external control possibilities. There is, however, an option for both potentiometer and binary control of voltage/reactive power/cos ϕ control.

We recommend using "Digital pot U/P.F. Optional Card". When this card is fitted, terminals 35, 36 and 37 are used as follows:

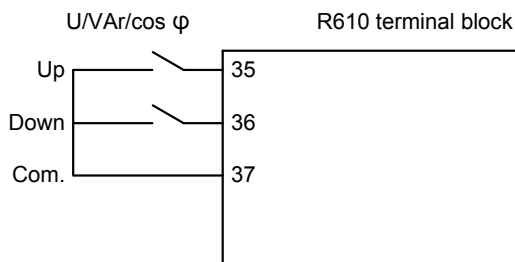

10.13 Leroy Somer type R610 3F AVR

The R610 3F external voltage control is intended for a 3-wire 10 k Ω potentiometer. Terminals used are 21, 22 and 23. The DEIF equipment is connected like this:

Combined analogue controls, 3-wire					
Input terminals			Resistor values		
IN 1 (+)	IN 2 (0)	IN 3 (signal)	Pot	R1	R2
21 (+)	23 (-)	22 (In)	10 k Ω	0 Ω	250 Ω

10.14 Marathon Magnamax/DVR 2000C AVR

The Magnamax/2000C accepts binary inputs directly on terminals 6D (lower voltage), 7 (common) and 6U (increase voltage).

To increase voltage: Connect 6U to 7.

To decrease voltage: Connect 6D to 7.

10.15 Marelli Mark 1 AVR

Direct analogue control			
Input terminals		Resistor values	
IN 1	IN 2	R1	R2
6 (+)	8 (-)	0 Ω	150 Ω

10.16 Marelli M25FA502A

The M25FA502A requires a +/-2.5V DC signal.



INFO

The signal must not exceed 3V DC in either direction. Set EPQ/EPN range to 2.5 V.

Direct analogue control			
Input terminals		Resistor values	
IN 1	IN 2	R1	R2
Q (+)	P (-)	0 Ω	125 Ω

10.17 Mecc-Alte S.R.7/2

Direct analogue control			
Input terminals		Resistor values	
IN 1	IN 2	R1	R2
7 (+)	5B (-)	0 Ω	470 Ω



INFO

EPQ96-2 terminals 11-12 must be linked (connected together) to activate the internal 500 Ω shunt in order to create a voltage output.



INFO

Output voltage range must be set to 9 V. Since the offset required is -80%, a special version of EPQ/EPN is needed.

10.18 Mecc-Alte type U.V.R. AVR

The Mecc-Alte U.V.R. has no terminal numbers, but the connection for external voltage control is placed next to the 50/60 Hz selection connection:

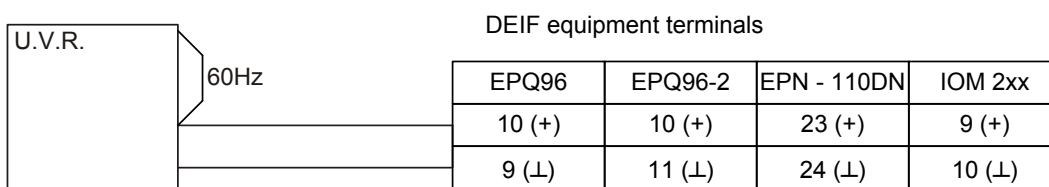

INFO

EPQ96-2 terminals 11-12 must be linked (connected together) to activate the internal 500 Ω shunt in order to create a voltage output.

**INFO**

Output voltage range must be set to 9 V. Since the offset required is -80%, a special version of EPQ/EPN is needed.

DELOMATIC/PPU/GPC/AGC/BGC output is +/-20 mA, so a resistor is needed to convert into 5V DC range:

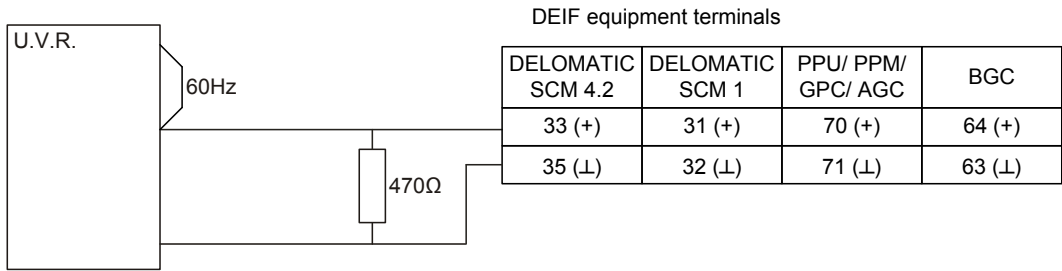
**INFO**

Set DEIF equipment output offset to -80%.

10.19 Stamford Newage type MA325, MA327, MX321, MX341, SR465, SX421 and SX440

These AVR's have an auxiliary input (terminal A1 and A2), which accepts voltage signals (+/-5 V). Therefore the DEIF equipment can usually be connected directly:

Direct analogue control			
Input terminals		Resistor values	
IN 1	IN 2	R1	R2
A1 (+)	A2 (-)	0 Ω	250 Ω

**INFO**

Stamford Newage type SX460 has no A1 and A2 terminals and cannot be controlled.

11. Troubleshooting

Problem indication	Problem cause	Remedy
Load sharing or parallel with mains power control unstable. Synchronisation OK. Single generator running frequency control OK.	No speed droop on generators.	Apply 3-4% speed droop on prime mover governor.
Load sharing control, or parallel with mains voltage (VAr), unstable. Synchronisation OK. Single generator running voltage control OK.	No voltage droop on generators.	Apply 3-4% voltage droop on generator AVR.
<u>Uni-line active power load sharing units only:</u> Load sharing or parallel with mains power control unstable. Synchronisation OK. Single generator running frequency control OK. Speed droop OK.	Faulty connection of measuring voltage and/ or current transformer input.	Correct connections. Voltage on L1 and L2, current transformer in L1.
<u>Uni-line active power load sharing units only:</u> Load sharing stable but not equal. Synchronisation OK. Single generator running frequency control OK. Speed droop OK.	Load sharers have been mounted to control the wrong size generators (can happen in systems with different size of generators).	Remount the load sharers to match the generators. The load sharers are preconfigured for a specific generator.
<u>Uni-line reactive power load sharing units only:</u> Load sharing or parallel with mains VAr control unstable. Synchronisation OK. Single generator running voltage control OK. Voltage droop OK.	Faulty connection of measuring voltage and/ or current transformer input and/or voltage transducer.	Correct connections. Voltage on L1 and L2, current transformer in L1, voltage transducer to US-line (term. 38 (+) and 39 (-)).
<u>Uni-line reactive power load sharing units only:</u> VAr load sharing stable but not equal. Synchronisation OK. Single generator running voltage control OK. Voltage droop OK.	VAr load sharers have been mounted to control the wrong size generators (can happen in systems with different size of generators).	Remount the VAr load sharers to match the generators. The VAr load sharers are preconfigured for a specific generator.
Generator not able to take load to 100%.	Initial setting of speed governor not correct.	See "Initial setting of speed governor/AVR".
Generator not able to take load to 100%.	Analogue output from DEIF equipment has too low output range.	Increase the full scale value. This is mostly a case when using electronic potentiometers.
Speed decreases when increase was expected (relay outputs).	Relay outputs "up" and "down" reversed.	Swap connections.
Speed decreases when increase was expected (analogue output).	Outputs "+" and "-" reversed.	Swap connections.