

AGC 150

CAN bus engine communication



1. Description of engine communication

1.1 Overview	8
1.1.1 J1939 and other protocols	8
1.1.2 Supported controllers and engines	9
1.1.3 Software version	12
1.1.4 AVR communication	13
1.1.5 Engineering units	13
1.1.6 Writing decimal and hexadecimal numbers	13
1.1.7 Parameter list	13
1.1.8 Terms and abbreviations	17
1.2 Warnings and safety	18
1.3 Legal information	18
1.4 Wiring	19
1.4.1 Communication principles	19
1.4.2 Terminals	19
1.5 Engine control commands	20
1.6 Show engine values in the display	20
1.7 M-Logic	20
1.7.1 Events	20
1.7.2 Commands	21
1.7.3 Using Modbus to activate M-Logic commands	22
1.8 Other	22
1.8.1 EIC derate	22
1.8.2 Differential measurement	22
1.8.3 Analogue readings PGN and SPN	23
1.8.4 SPN ignore list	24
1.8.5 Displaying proprietary text for SPN/FMI combinations	25

2. Generic J1939

2.1 Generic J1939 overview	26
2.2 General	27
2.2.1 Displaying alarms	27
2.2.2 Write commands	27
2.2.3 Wait to start	28
2.2.4 TSC1 SA Torque Speed Control	28
2.2.5 Tier 4/Stage V	28
2.2.6 J1939 measurements	30
2.2.7 Modbus alarms	34
2.2.8 Modbus analogue values	35
2.3 J1939/75	35
2.3.1 J1939/75 DM1s	36
2.4 Troubleshooting	37
2.4.1 Diagnostic codes	37
2.4.2 Troubleshooting the CAN bus connection	39

3. J1939 ECUs and engines

3.1 ANGLE	41
3.1.1 ANGLE	41
3.2 Baudouin	42

3.2.1 Baudouin Wise10B.....	42
3.2.2 Baudouin Wise 15.....	43
3.2.3 Baudouin Gas.....	44
3.2.4 Warnings and shutdowns.....	45
3.2.5 Write commands.....	45
3.3 Bosch.....	46
3.3.1 Bosch EDC17.....	46
3.4 Caterpillar.....	47
3.4.1 Caterpillar ADEM3.....	47
3.4.2 Caterpillar ADEM4.....	48
3.4.3 Caterpillar ADEM6.....	49
3.4.4 Caterpillar Generic.....	50
3.4.5 Warnings and shutdowns.....	51
3.4.6 Display texts.....	51
3.4.7 Write commands.....	52
3.4.8 M-Logic (Caterpillar ADEM6).....	52
3.4.9 J1939 measurements.....	52
3.4.10 Modbus analogue values.....	53
3.4.11 Modbus alarms.....	54
3.5 Cummins.....	55
3.5.1 Cummins CM 500.....	55
3.5.2 Cummins CM 558.....	56
3.5.3 Cummins CM 570.....	57
3.5.4 Cummins CM 850.....	58
3.5.5 Cummins CM 2150.....	59
3.5.6 Cummins CM 2250.....	60
3.5.7 Cummins Generic.....	61
3.5.8 Cummins CM 2350.....	62
3.5.9 Cummins CM 2850.....	63
3.5.10 Cummins CM 2880.....	64
3.5.11 Cummins KTA19.....	65
3.5.12 Warnings and shutdowns.....	66
3.5.13 Write commands.....	66
3.5.14 Cummins After Treatment.....	66
3.5.15 Modbus alarms.....	67
3.6 Detroit Diesel.....	69
3.6.1 Detroit Diesel DDEC III.....	69
3.6.2 Detroit Diesel DDEC IV.....	70
3.6.3 Write commands.....	71
3.6.4 Modbus alarms.....	71
3.7 Deutz.....	72
3.7.1 Deutz EMR2.....	72
3.7.2 Deutz EMR3.....	73
3.7.3 Deutz EMR4.....	74
3.7.4 Deutz EMR5.....	75
3.7.5 Deutz EMR4/EMR5 Stage V.....	76
3.7.6 Warnings and shutdowns.....	77
3.7.7 Write commands.....	77
3.7.8 M-Logic (Deutz EMR5).....	77

3.7.9 Modbus alarms.....	77
3.8 Doosan.....	79
3.8.1 Doosan EDC17.....	79
3.8.2 Doosan MD1.....	80
3.8.3 Doosan stage 5.....	81
3.8.4 M-Logic events.....	81
3.9 FPT Industrial.....	83
3.9.1 FPT Industrial EDC17.....	83
3.9.2 FPT Industrial Bosch MD1.....	84
3.9.3 M-Logic events.....	84
3.10 Hatz Diesel.....	86
3.10.1 Hatz Diesel 3H50TICD, 4H50TICD.....	86
3.10.2 Hatz Diesel EDC17.....	87
3.11 Isuzu.....	88
3.11.1 Isuzu ECM.....	88
Write commands.....	89
Escape mode.....	89
Purge function.....	89
Tier 4 aftertreatment support.....	89
Modbus analogue values.....	89
3.12 Iveco.....	91
3.12.1 Iveco CURSOR.....	91
3.12.2 Iveco NEF.....	92
3.12.3 Iveco EDC7 (Bosch MS6.2).....	93
3.12.4 Iveco VECTOR 8.....	94
3.12.5 Iveco Generic.....	95
3.12.6 Iveco Bosch MD1.....	96
3.12.7 Warnings and shutdowns.....	97
3.12.8 Write commands.....	97
3.12.9 J1939 measurements.....	97
3.12.10 Modbus alarms.....	97
3.13 JCB.....	99
3.13.1 JCB.....	99
3.13.2 JCB 430/448 Stage V.....	100
3.14 Jichai.....	101
3.14.1 Jichai JC15D-ECU22.....	101
3.14.2 Jichai JC15D WYS.....	102
3.14.3 Jichai JC190.....	103
3.14.4 Jichai JC15T JG.....	104
3.15 Jing Guan.....	105
3.15.1 Jing Guan.....	105
3.16 John Deere.....	106
3.16.1 John Deere PowerTech M, E and Plus.....	106
3.16.2 John Deere FOCUS controls.....	107
3.16.3 Warnings and shutdowns.....	108
3.16.4 Write commands.....	108
3.16.5 Tier 4 aftertreatment support.....	108
3.16.6 Modbus alarms.....	108

3.17 Kohler	110
3.17.1 Kohler KD62V12.....	110
3.17.2 Kohler KDI 3404.....	111
3.17.3 Write commands.....	112
3.17.4 ECU reset.....	112
3.18 Kubota	114
3.18.1 Kubota KORD3.....	114
3.18.2 M-Logic.....	115
3.19 MAN	116
3.19.1 MAN EDC17.....	116
3.19.2 MAN EMC 2.0.....	117
3.19.3 MAN EMC 2.5.....	118
3.19.4 MAN Generic.....	119
3.20 MTU (J1939)	120
3.20.1 MTU J1939 Smart Connect.....	120
3.20.2 MTU ECU8.....	121
3.20.3 MTU ECU9.....	122
3.20.4 Alarm texts.....	123
3.20.5 Tier 4 aftertreatment support.....	140
3.20.6 Write commands.....	140
3.20.7 J1939 measurement.....	142
3.20.8 M-Logic events.....	142
3.20.9 Modbus alarms.....	142
3.20.10 Modbus analogue values.....	145
3.21 Perkins	147
3.21.1 Perkins ADEM3.....	147
3.21.2 Perkins ADEM4.....	148
3.21.3 Perkins Generic.....	149
3.21.4 Perkins EDC17.....	150
3.21.5 Perkins Series 400.....	151
3.21.6 Perkins Series 1200F.....	152
3.21.7 Perkins Series 400 and 1200.....	153
3.21.8 Perkins Series 1200J.....	154
3.21.9 Write commands.....	154
3.21.10 Safe signal for regeneration.....	155
3.21.11 Modbus alarms.....	155
3.22 PSI/Power Solutions	156
3.22.1 Write commands.....	157
3.23 Scania	158
3.23.1 Scania EMS.....	158
3.23.2 Scania EMS S6.....	159
3.23.3 Scania EMS2 S8.....	160
3.23.4 Scania S8 Industrial.....	161
3.23.5 Displaying alarms.....	161
3.23.6 Error log.....	162
3.23.7 Warnings and shutdowns (DLN2 alarms).....	163
3.23.8 Write commands for Scania EMS.....	163
3.23.9 Write commands for Scania EMS 2.....	164
3.23.10 Safe signal for regeneration.....	164

3.23.11 M-Logic (Scania EMS2 S8).....	165
3.23.12 Modbus alarms.....	165
3.24 Steyr.....	167
3.24.1 Steyr EDC.....	167
3.25 Volvo Penta.....	168
3.25.1 Volvo Penta Generic EDC.....	168
3.25.2 Volvo Penta EDC3.....	169
3.25.3 Volvo Penta EDC4.....	170
3.25.4 Volvo Penta Generic EMS.....	171
3.25.5 Volvo Penta EMS2.3.....	172
3.25.6 Volvo Penta EMS 2.4.....	173
3.25.7 Warnings and shutdowns.....	174
3.25.8 Second ECU.....	174
3.25.9 Volvo speed control.....	174
3.25.10 Tier 4 aftertreatment support.....	174
3.25.11 Emergency Inducement Override.....	175
3.25.12 M-Logic events.....	175
3.25.13 Write commands.....	175
3.25.14 Modbus alarms.....	175
3.26 Weichai.....	177
3.26.1 Weichai Diesel.....	177
3.26.2 Weichai Gas.....	178
3.26.3 Weichai Wise 10B.....	179
3.26.4 Weichai Wise 15.....	180
3.26.5 Weichai Baudouin E6 Gas.....	181
3.27 Xichai.....	182
3.27.1 Xichai Gas.....	182
3.28 YANMAR.....	183
3.28.1 YANMAR EDC17.....	183
3.28.2 YANMAR stage V.....	184
3.29 Yuchai.....	185
3.29.1 Yuchai United Diesel.....	185
3.29.2 Yuchai United Gas.....	186
3.29.3 Yuchai United YC-BCR.....	187
3.29.4 Yuchai United YC-ECU.....	188
4. CANopen ECUs and engines	
4.1 MTU ADEC (CANopen).....	189
4.1.1 Warnings.....	189
4.1.2 Shutdown.....	190
4.1.3 Display texts.....	190
4.1.4 Write commands.....	191
4.1.5 Modbus alarms.....	192
4.1.6 Modbus analogue values.....	193
4.2 MTU ADEC module 501.....	195
4.2.1 Display texts.....	195
4.2.2 Displaying alarms.....	196
4.2.3 Write commands.....	197
4.2.4 Modbus alarms.....	198

- 4.3 MTU ECU7 with SAM.....199**
- 4.4 MTU MDEC module 201.....199**
- 4.5 MTU MDEC module 302/303.....200**
 - 4.5.1 MTU MDEC module 302.....200
 - 4.5.2 MTU MDEC module 303.....200
 - 4.5.3 Displaying alarms.....200
 - 4.5.4 Display texts.....201
 - 4.5.5 Write commands.....202
 - 4.5.6 Modbus alarms.....202
 - 4.5.7 Modbus analogue values.....204
- 4.6 MTU MDEC module 304 overview.....205**
 - 4.6.1 Write commands.....205
- 4.7 QiYao.....206**

1. Description of engine communication

1.1 Overview

There can be CAN bus communication between AGC 150 and several engine types.

The AGC receives information from the Electronic Control Unit (ECU) of the engine. The AGC can use the information as input for its own control functions. The AGC can also use the information as display values, alarms, shutdown alarms and as values to be transmitted through Modbus. If the ECU allows it, the AGC can send telegrams with commands and set points.

You can read the engine data from the AGC over Modbus. See the **Modbus tables** for more information.

For the AGC engine communication parameters, see the [Parameter list](#).

See the ECU user manuals for the ECU protocol technical description and details of each communication value.

General default values

For each protocol, unless otherwise mentioned:

- The protocol is based on J1939.
- The baud rate is 250 kb/s.

1.1.1 J1939 and other protocols

J1939-based protocols

Most of the engine communication protocols are based on SAE J1939. J1939 is a very large standard, and most of it is irrelevant to engine communication. The AGC supports only relevant parts of J1939. The parts of J1939 that the AGC supports are described in [Generic J1939](#).

If your ECU is not included in **J1939 ECUs and engines** chapter, you can use the parts of J1939 that the AGC and ECU both support.

If the ECU is included in **J1939 ECUs and engines** chapter, you can use the parts of J1939 that the AGC and ECU both support. You can also use the custom functions described for the specific ECU.

Relationship between the AGC and ECU for J1939

Information	Communication	Included in the AGC J1939	Not included in the AGC J1939	J1939 ECUs and engines
Alarms	The ECU broadcasts the information as a SPN+FMI combination.	The AGC has an alarm text for each SPN+FMI combination.	The AGC displays the SPN+FMI. The user can look up the SPN in the J1939 standard. The AGC also displays the text "N/A" and uses the FMI to add text like "High" or "Most severe".	The AGC assigns texts to the proprietary alarms listed in this document. Controllers can also display special proprietary text for SPN/FMI combinations. Some ECUs use proprietary alarm systems. For example, Scania uses KWP2000.
Statuses	The ECU broadcasts the information as a PGN number, with each status defined by a bit.	The AGC treats the information like a digital input.	The AGC ignores the information.	The AGC has custom functions for the additional/proprietary statuses listed in this document.

Information	Communication	Included in the AGC J1939	Not included in the AGC J1939	J1939 ECUs and engines
Measurements	The ECU broadcasts the CAN ID, with a priority and the information as a PGN number, with each measurement defined by a byte or 2.	The AGC treats the information like an analogue input. The measurements can activate alarms. Some measurements can be used for running detection, and others can activate Tier 4 actions (for example, DEF level shutdown).	The AGC ignores the information.	The AGC has custom functions for the additional/proprietary measurements listed in this document.
Commands	The AGC sends a telegram with the command.	The AGC can send the telegram. If the ECU supports the command, it responds accordingly.	The AGC will not send the telegram.	The AGC can send the additional telegrams listed in this document.
Set points	The AGC sends a telegram with the set point at regular intervals. Set points are mostly used for speed regulation. Some ECUs allow idle speed and frequency regulation.	The AGC can send the telegram. If the ECU supports the set point, it responds accordingly.	The AGC will not send the telegram.	The AGC can send the additional telegrams listed in this document.

CANopen protocols

MTU MDEC and ADEC communication is NOT based on J1939, but on MTU proprietary protocols. See the **CANopen ECUs and engines** chapter for a full description of how the AGC supports each of the protocols.

NOTE The **MTU J1939 Smart Connect, ECU8 and ECU9** protocols are based on J1939.

Other engines and controllers

If you have an engine or controller that is not listed in this document, contact DEIF.

1.1.2 Supported controllers and engines

The AGC can communicate with the following ECUs and engines.

Manufacturer	ECU	Engines	Tier 4/Stage V	AGC parameter 7561
Generic J1939	Any ECU that uses J1939	Any engine that uses J1939	●	Generic J1939
ANGLE			-	ANGLE
Baudouin	WOODWARD PG+	-	-	Baudouin Gas
Baudouin	Wise 10B	-	-	Baudouin Wise10B
Baudouin	Wise 15	-	●	Baudouin Wise15
Bosch	EDC17			Bosch EDC17CV54TMTL
Caterpillar	ADEM3	C4.4, C6.6, C9, C15, C18, C32, 3500, 3600	-	Caterpillar ADEM3
Caterpillar	ADEM4		-	Caterpillar ADEM4
Caterpillar	ADEM6		-	Caterpillar ADEM6

Manufacturer	ECU	Engines	Tier 4/Stage V	AGC parameter 7561
Caterpillar	ADEM3, ADEM4	C4.4, C6.6, C9, C15, C18, C32, 3500, 3600	-	Caterpillar Generic*
Cummins	CM 500	QSL, QSB5, QSX15 and 7, QSM11, QSK 19/23/50/60	-	Cummins CM500
Cummins	CM 558	QSL, QSB5, QSX15 and 7, QSM11, QSK 19/23/50/60	-	Cummins CM558
Cummins	CM 570	QSL, QSB5, QSX15 and 7, QSM11, QSK 19/23/50/60	-	Cummins CM570
Cummins	CM 850	QSL, QSB5, QSX15 and 7, QSM11, QSK 19/23/50/60	-	Cummins CM850
Cummins	CM 2150	QSL, QSB5, QSX15 and 7, QSM11, QSK 19/23/50/60	●	Cummins CM2150
Cummins	CM 2250	QSL, QSB5, QSX15 and 7, QSM11, QSK 19/23/50/60	●	Cummins CM2250
Cummins	CM 500, CM 558, CM 570, CM 850, CM 2150 and CM 2250	-	ECU-dependent	Cummins Generic*
Cummins	CM 2350		●	Cummins CM2350
Cummins	CM 2850		●	Cummins CM2850
Cummins	CM 2880		●	Cummins CM2880
Cummins	-	KTA19	-	Cummins KTA19
Detroit Diesel	DDEC III	Series 50, 60 and 2000	-	DDEC III
Detroit Diesel	DDEC IV	Series 50, 60 and 2000	-	DDEC IV
Detroit Diesel	DDEC III, DDEC IV	Series 50, 60 and 2000	-	DDEC Generic*
Deutz	EMR2	-	-	Deutz EMR 2
Deutz	EMR3	-	-	Deutz EMR 3
Deutz	EMR 2, EMR 3	-	-	Deutz EMR Generic*
Deutz	EMR4	-	-	Deutz EMR 4
Deutz	EMR5	-	-	Deutz EMR 5
Deutz	EMR4/EMR5 Stage V	-	●	Deutz EMR 5 Stage V
Doosan	EDC17	-	-	Doosan G2 EDC17
Doosan	MD1	-	●	Doosan MD1
Doosan	G2 EDC17	-	●	Doosan stage 5
FPT Industrial	EDC17	-	-	FPT EDC17CV41
FPT Industrial	Bosch MD1	-	●	FPT stage V
Hatz Diesel	-	3/4H50 TICD	●	Hatz
Hatz Diesel	EDC17	-	-	Hatz EDC17
Isuzu	ECM	4JJ1X, 4JJ1T, 6WG1X FT-4	-	Isuzu
Iveco	CURS0R	-	-	Iveco CURS0R
Iveco	EDC7 (Bosch MS6.2),	-	-	Iveco EDC7
Iveco	NEF	-	-	Iveco NEF
Iveco	VECTOR 8	-	-	Iveco Vector8

Manufacturer	ECU	Engines	Tier 4/Stage V	AGC parameter 7561
Iveco	CURSOR, NEF, EDC7, VECTOR 8		●**	Iveco Generic*
Iveco	Bosch MD1	-	●	Iveco Stage V
JCB	-	ECOMAX DCM3.3+	●	JCB
JCB		P745 & P740 DieselMax Stage V Version 7	●	JCB 430/448 Stage V
Jichai	JC15D-ECU22	-	-	JC15D Weifu***
Jichai	JC15D WYS		-	JC15D WYS
Jichai	JC190		-	JC190
Jichai	JC15T JG		-	Jichai JC15T JG
Jing Guan		Gas	-	Jing Guan
John Deere	JDEC	PowerTech M, E and Plus	●	John Deere
John Deere	FOCUS controls (version 2.1)	-	●	John Deere Stage V
Kohler	ECU2-HD	KD62V12	●	Kohler KD62V12
Kohler	-	KDI 3404	-	Kohler KDI 3404
Kubota	KORD3		●	Kubota Stage V
MAN	EDC17	-		MAN EDC17
MAN	EMC 2.0	-	-	MAN EMC Step 2.0
MAN	EMC 2.5	-	-	MAN EMC Step 2.5
MAN	EMC 2.0 and 2.5	-	-	MAN Generic*
MTU	MDEC, module M.201	-		MDEC 2000/4000 M.201
MTU	MDEC module M.302	Series 2000 and 4000	-	MDEC 2000/4000 M.302
MTU	MDEC module M.303	Series 2000 and 4000	-	MDEC 2000/4000 M.303
MTU	MDEC, module M.304	-		MDEC 2000/4000 M.304
MTU	ADEC	Series 2000 and 4000 (ECU7), MTU PX	-	MTU ADEC
MTU	ADEC, ECU7 without SAM module (software module 501)	Series 2000 and 4000	-	MTU ADEC module 501
MTU	ECU7 with SAM module	-	-	MTU ECU7 with SAM
MTU	ECU8	-	-	MTU ECU8
MTU	ECU9	-	●	MTU ECU9
MTU	J1939 Smart Connect, ECU8, ECU9	Series 1600	● (ECU9 or later)	MTU J1939 Smart Connect
Perkins	ADEM3	-	-	Perkins ADEM3
Perkins	ADEM4	-	-	Perkins ADEM4
Perkins	ADEM3 and ADEM4	Series 850, 1100, 1200, 1300, 2300, 2500 and 2800	-	Perkins Generic*
Perkins	EDC17	-	-	Perkins EDC17C49
Perkins	-	Series 400 and 1200	●	Perkins Stage V

Manufacturer	ECU	Engines	Tier 4/Stage V	AGC parameter 7561
Perkins	-	Series 400 Model IQ IR IW IY IF	●	Perkins StV 400
Perkins	-	Series 1200F Model MT, MU, MV, MW, BM and BN	●	Perkins StV 1200
Perkins	-	Series 1200J Model SU, VM	●	Perkins StV 120xJ (SU/VM)
PSI/Power Solutions	-	PSI/Power Solutions	●	PSI/Power Solutions
QiYao			-	QiYao Gas
Scania	EMS	-	-	Scania EMS
Scania	EMS S6 (KWP2000)	Dx9x, Dx12x, Dx16x	-	Scania EMS 2 S6
Scania	EMS 2 S8	DC9, DC13, DC16	●	Scania EMS 2 S8
Scania	EMS 2 S8	DC9, DC13, DC16	●	Scania S8 Industrial
Steyr	EDC17	-	-	Steyr EDC17
Volvo Penta	EDC3	-	-	Volvo Penta EDC3
Volvo Penta	EDC4	-	-	Volvo Penta EDC4
Volvo Penta	EDC III, EDC IV	TAD4x, TAD5x, TAD6x, TAD7x	-	Volvo Penta Generic*
Volvo Penta	EMS, EMS 2.0 to EMS2.3	D6, D7, D9, D12, D16 (GE and AUX variants only)	●	Volvo Penta EMS2
Volvo Penta	EMS2.3		●	Volvo Penta EMS2.3
Volvo Penta	EMS2.4	-	●	Volvo Penta EMS 2.4
Weichai	WOODWARD PG+	Diesel	●	Weichai Diesel
Weichai	WOODWARD PG+	Gas	●	Weichai Gas
Weichai	Wise 10B	-	●	Weichai Wise10B
Weichai	Wise 15	-	●	Weichai Wise15
Weichai			-	Weichai Baudouin E6 Gas
Xichai				Xichai Gas
YANMAR	EDC17	-	-	YANMAR EDC17
YANMAR	-	-	-	YANMAR Stage V
Yuchai United	YCGCU (Version 4.2)	Diesel	●	Yuchai United Diesel
Yuchai United	YCGCU (Version 4.2)	Gas	●	Yuchai United Gas
Yuchai United	YC-BCR	-	-	Yuchai YC-BCR
Yuchai United	YC-ECU	-	-	Yuchai YC-ECU

NOTE * Generic protocols are included for backward compatibility.

NOTE ** If supported by the ECU and engine.

NOTE *** Previously *Jichai*

Other EIC protocols: Contact DEIF.

1.1.3 Software version

This document is based on the AGC 150 software version 1.17

1.1.4 AVR communication

This document primarily describes CAN bus **engine** communication.

Data can also be transmitted over CAN bus between the AGC and the following AVRs:

Manufacturer	AVR Types
Caterpillar	CDVR
DEIF	DVC 550, DVC 350, and DVC 310



More information

See the **DVC 550 Designer's handbook** for information about communication with DVC 550. See the **DVC 350 Designer's handbook** for information about communication with DVC 350. See **Option T2** on the DVC 310 product page for information about communication with DVC 310.

1.1.5 Engineering units

Use parameter 9158 (Engineering units) to select *Bar/Celsius* or *Psi/Fahrenheit*.

The selection affects:

- The display readings
- The values used for alarm evaluation (menu 76xx)
- The data readable by Modbus communication

1.1.6 Writing decimal and hexadecimal numbers

Unless otherwise specified, all numbers in this document are decimal numbers.

Hexadecimal numbers start with 0x. For example, 0x1C is 28.

1.1.7 Parameter list

This is an overview of the parameters used in engine communication. See the descriptions in the rest of this document for more information.

Parameter	Name	Range	Default	Details
2771	Droop	0 to 25 %	0 %	Only for Scania.
2772	Scania rpm	User 1500RPM 1800RPM Low idle	User	Only for Scania.
2773	Cummins gain	0 to 10	5	Only for Cummins.
2781	Reg. output GOV	Relay/Analogue/EIC	EIC	Select EIC to enable the AGC to do speed control through the ECU.
2782	Reg. output AVR	Relay/Analogue/EIC	Analogue	
2791	Local Norm sw.	Analogue CAN Up/Down ECU Up/Down CAN Analogue ECU Analogue ECU relative Frequency	Analogue CAN	EIC speed demand switch setup: local normal switch position.

Parameter	Name	Range	Default	Details
2792	Local Emerg sw.	Analogue CAN Up/Down ECU Up/Down CAN Analogue ECU Analogue ECU relative Frequency	Analogue CAN	EIC speed demand switch setup: local emergency switch position.
2793	Remote Norm sw.	Analogue CAN Up/Down ECU Up/Down CAN Analogue ECU Analogue ECU relative Frequency	Analogue CAN	EIC speed demand switch setup: remote normal switch position.
2794	Remote Emerg sw.	Analogue CAN Up/Down ECU Up/Down CAN Analogue ECU Analogue ECU relative Frequency	Analogue CAN	EIC speed demand switch setup: remote emergency switch position.
7551	EIC Derate	Enable	Not enabled	
7552	EIC Livelink	OFF JCB Livelink	OFF	
7561	Engine I/F	OFF Generic J1939 IOM-220/230 KWG ISO5 isolation monitor See Supported controllers and engines for the full list.	Generic J1939	<p>Use this parameter to select the engine protocol.</p> <p>You can daisy-chain IOM-220/230 and/or a KWG ISO5 isolation monitor with a J1939 ECU on the CAN bus terminals. If any J1939 engine protocol is selected, the IOM and/or KWG are automatically detected.</p> <p>If no J1939 engine protocol is selected:</p> <ul style="list-style-type: none"> • If both IOM-220/230 and KWG ISO5 isolation monitor are present: Select <i>KWG ISO5 isolation monitor</i> • If only a KWG ISO5 isolation monitor is present: Select <i>KWG ISO5 isolation monitor</i> • If IOM-220/230 is present: Select <i>IOM-220/230</i> <p>For information on the <i>KWG ISO5 isolation monitor</i>, see the Designer's handbook.</p>
7562	EIC SA/ADEC ID	0 to 255	0	Engine ECU source address.
7563	EIC Controls	ON/OFF	ON	Enable writing commands to the ECU.
7564	EIC Auto View	ON/OFF	OFF	Extra display views in V1 and V2 showing all EIC engine data.
7566	EIC TSC1 SA	-1 to 255	-1	EIC speed/Torque control source address. If -1, the pre-programmed source address is used.
7570	EI Comm. error	Alarm selections	Not enabled	Supervision of the engine communication CAN bus.

Parameter	Name	Range	Default	Details
				Activates M-Logic Events, Alarms - EIC, EIC Comm. error.
7580	EIC Warning	Alarm selections	Not enabled	Any alarm listed as a warning for the specific engine type (yellow lamp) (based on the EIC reading). Activates M-Logic Events, Alarms - EIC, EIC Warning.
7590	EIC Shutdown	Alarm selections	Not enabled	Any alarm listed as a shutdown for the specific engine type (red lamp) (based on the EIC reading). Activates M-Logic Events, Alarms - EIC, EIC Shutdown.
7600	EIC Overspeed	Alarm selections	Not enabled	Engine RPM (based on the EIC reading). Activates M-Logic Events, Alarms - EIC, EIC Overspeed.
7610	EIC Coolant T.1	Alarm selections	Not enabled	High engine temperature (from coolant temperature) (based on the EIC reading). Activates M-Logic Events, Alarms - EIC, EIC Coolant Temp 1.
7620	EIC Coolant T.2	Alarm selections	Not enabled	High engine temperature (from coolant temperature) (based on the EIC reading). Activates M-Logic Events, Alarms - EIC, EIC Coolant Temp 2.
7630	EIC Oil pres. 1	Alarm selections	Not enabled	High engine pressure (based on the EIC reading). Activates M-Logic Events, Alarms - EIC, EIC Oil pressure 1.
7640	EIC Oil pres. 2	Alarm selections	Not enabled	High engine pressure (based on the EIC reading). Activates M-Logic Events, Alarms - EIC, EIC Oil pressure 2.
7650	EIC Oil temp. 1	Alarm selections	Not enabled	High engine temperature (from oil temperature) (based on the EIC reading). Activates M-Logic Events, Alarms - EIC, EIC Oil temperature 1.
7660	EIC Oil temp. 2	Alarm selections	Not enabled	High engine temperature (from oil temperature) (based on the EIC reading). Activates M-Logic Events, Alarms - EIC, EIC Oil temperature 2.
7670	EIC Coolant L. 1	Alarm selections	Not enabled	Low engine coolant level (based on the EIC reading).

Parameter	Name	Range	Default	Details
				Activates M-Logic Events, Alarms - EIC, EIC Coolant Level 1.
7680	EIC Coolant L. 2	Alarm selections	Not enabled	Low engine coolant level (based on the EIC reading). Activates M-Logic Events, Alarms - EIC, EIC Coolant Level 2.
7841	CAN A Protocol	OFF, H5 EIC, Canshare, AOP2, Digital AVR, Ext. Modules DEIF	H5 EIC	
7842	CAN B Protocol	OFF, PMS Primary, H5 EIC, Canshare, AOP2, PMS Secondary, Digital AVR, Ext. Modules DEIF	PMS Primary	
9158	Engineering units	Bar/celsius Psi/fahrenheit	Bar/celsius	See Engineering units .
15000	Izuzu ESCmode SD thr	Time delay	Not enabled	Timer threshold for engine shutdown during escape mode.
15010	Kohler ECU reset	Relay selection	Not enabled	Selection of the relay and parameters to reset the ECU.
15022	Livelink Fuel 1	OFF, Multi input 20/21/22/23	Multi input 22	To send the associated measurement as a DM1 to J1939/75 (JCB Livelink), select the AGC input.
15023	Livelink Fuel 2		Multi input 23	
15024	Livelink Oil press		Multi input 21	
15025	Livelink Coolant		Multi input 20	
15030	CM1 source address	-1 to 255	-1	Selection of EIC J1939 CAB message 1 source address. If -1 , the AGC uses the default. The AGC telegrams for DPF regeneration use this source address.
15040	GC1 source address	-1 to 255	-1	Selection of EIC J1939 Generator Control 1 source address. If -1 , the AGC uses the default. If the M-Logic <i>EIC Start/Stop enable</i> command is activated, the start/stop telegram uses this source address.
15070	High SOOT warning	-100 to 100 % 0 to 32767 s	95 % 3600 s	Alarm activated by high soot levels. Default setting is warning.
15080	High SOOT shutdown	-100 to 100 % 0 to 32767 s	98 % 7200 s	Alarm activated by high soot levels. Default setting is engine shut down.
15090	EIC Start/Stop	OFF ON	ON	This has the same effect as the M-Logic command <i>EIC Start/Stop enable</i> .
15100	Freq/Rpm offset	Use nominal frequency, Use nominal RPM	Use nominal frequency	Select whether frequency or RPM is used for speed offset for J1939 protocols. This parameter does not affect all Cummins protocols. This parameter also does not affect Volvo Penta if proprietary engine speed control is selected in parameter 15110.
15110	Volvo speed control	Standard J1939	Standard J1939	For all Volvo Penta engines, you can select the primary speed of the engine (that is, the

Parameter	Name	Range	Default	Details
		Volvo proprietary - Primary speed 50Hz Volvo proprietary - Primary speed 60Hz		speed configured for the engine at the factory) to ensure the correct proprietary telegrams for speed control.
15120	TSC1 TX rate	Default transmission rate 10ms transmission rate 20ms transmission rate 40ms transmission rate 50ms transmission rate 100ms transmission rate	Default transmission rate	Configure the transmission rate for generic J1939.
15130	TSC1 cs and counter	Default On Off	Default	Enable/disable the TSC1 checksum and counter for generic J1939.
15140	Ack alarm over J1939	On Off	On	Enable/Disable <i>Acknowledge all alarms</i> using J1939 (DM11).

1.1.8 Terms and abbreviations

Term	Abbreviation	Explanation
AGC	AGC	The DEIF controller.
CAN bus		A standard for devices to communicate with each other.
CANopen		A high-level communication protocol based on the CAN protocol.
Diagnostic message	DM1, DM1se, DM2	An alarm from the ECU. DM1: Active EIC alarms DM1se: Active EIC alarms from the secondary ECU DM2: History EIC alarms
Diesel Exhaust Fluid	DEF	Used to reduce NOx emissions from diesel engines.
Diesel particulate filter	DPF	An after-treatment technology used to reduce emission of carbon particles.
Electronic control unit	ECU	The part of the engine controller that communicates with the AGC. This is sometimes called an electronic control module (ECM).
Engine interface communication	EIC	
Engine power	kWm	The kW output on the engine shaft. The generator electrical output is lower (due to losses).
Failure Mode Identifier	FMI	A J1939 number to show the severity of a fault.
Occurance counter	OC	The number of times an alarm has been activated.
Parameter Group Number	PGN	The part of the J1939 message that identifies the data type.
Receive	Rx	The AGC receives data from the ECU.
Red lamp alarm		Shutdown alarm
	RS-485	A serial bus standard. RS-485 communication is not described in this document.
	SAE J1939	A Vehicle Network Communication standard using CAN for communication.
Selective catalytic reduction	SCR	An after-treatment technology used to control NOx.

Term	Abbreviation	Explanation
Society of Automotive Engineers	SAE	The group that developed the J1939 protocol.
Stage V		The European (EU) standard to limit diesel emissions from machinery engines.
Suspect Parameter Number	SPN	A J1939 number to show the type of fault (for example, warning or shutdown).
Tier 4 Final	Tier 4	The US Environmental Protection Agency (EPA) standard to limit diesel emissions from machinery engines.
Transmit	Tx	The AGC transmits data to the ECU.
Yellow lamp alarm		Warning alarm

1.2 Warnings and safety

Safety during installation and operation

Installing and operating the controller may require work with dangerous currents and voltages. The installation must only be carried out by authorised personnel who understand the risks involved in working with electrical equipment.



DANGER!

Hazardous live currents and voltages. Do not touch any terminals, especially the AC measurement inputs and the relay terminals. Touching the terminals could lead to injury or death.

Factory settings

The controller is delivered pre-programmed from the factory with a set of default settings. These settings are based on typical values and may not be correct for your system. You must therefore check all parameters before using the controller.

Electrostatic discharge

Electrostatic discharge can damage the controller terminals. You must protect the terminals from electrostatic discharge during the installation. When the controller is installed and connected, these precautions are no longer necessary.

Data security

To minimise the risk of data security breaches:

- As far as possible, avoid exposing controllers and controller networks to public networks and the Internet.
- Use additional security layers like a VPN for remote access, and install firewall mechanisms.
- Restrict access to authorised persons.

1.3 Legal information

Third party equipment

DEIF takes no responsibility for the installation or operation of any third party equipment, including the **genset**. Contact the **genset company** if you have any doubt about how to install or operate the genset.

Warranty

NOTICE



Warranty

The controller is not to be opened by unauthorised personnel. If opened anyway, the warranty will be lost.

Disclaimer

DEIF A/S reserves the right to change any of the contents of this document without prior notice.

The English version of this document always contains the most recent and up-to-date information about the product. DEIF does not take responsibility for the accuracy of translations, and translations might not be updated at the same time as the English document. If there is a discrepancy, the English version prevails.

Copyright

© Copyright DEIF A/S. All rights reserved.

Trademarks

All trademarks are the properties of their respective owners.

1.4 Wiring

1.4.1 Communication principles

Principle diagram

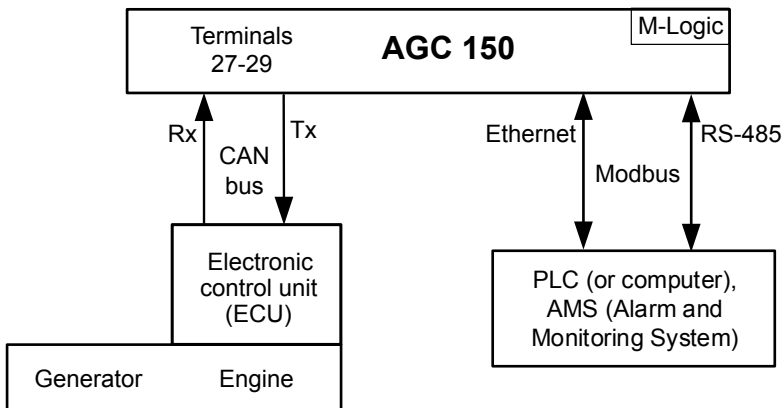

More information

See the **Installation instructions** for wiring details.

1.4.2 Terminals

Engine communication uses these AGC 150 terminals:

Terminal	Function	Description
27	CAN A High	CAN bus card Engine Interface communication
28	CAN A GND	
29	CAN A Low	

1.5 Engine control commands

The AGC can send standard J1939 engine control commands. These are described in the **Generic J1939** chapter.

The control commands supported for each engine/controller type are described in the **J1939 ECUs and engines** chapter. If the required commands are not listed, then the start/stop and/or other commands must be sent to the controller using hardwired connections.

1.6 Show engine values in the display

You can configure the AGC so that the operator can see the values from the ECU in the display. By default, 20 views are available. Use the Autoview function to increase the number of views.

Default view configuration

Use the PC Utility Software function *Configuration of the user views*. The function icon is in the horizontal toolbar: . Up to 20 five-line views can be configured.

This method is useful if the 20 user-configurable views are not already required for other values, and/or only a few EIC values need to be shown.

Autoview function

You can activate the Autoview function in parameter 7564 (EIC Auto view). This way the first 20 five-line views are not changed and are user-configurable. The additional 14 five-line views are dedicated to EIC and not configurable.

This method is useful if the operator needs to see all the EIC data from the ECU. All available EIC data is shown until the additional 14 five-line views are used.

Activating Autoview

The extra view lines are displayed if parameter 7564 is **On** and the engine CAN bus is active. You may need to start the engine before changing 7564 to **On**. The parameter automatically returns to **Off**.

Deactivating Autoview

Autoview is not reset automatically when no engine is selected. To de-activate Autoview:

1. Change Engine I/F type to **OFF** (parameter 7561).
2. Change EIC Auto view to **On** (parameter 7564).
3. Change EIC Auto view to **Off** (parameter 7564).

1.7 M-Logic

1.7.1 Events

The following events are available in M-Logic under *Events, EIC event*. The events listed here are only for J1939 protocols.

See [Tier 4/Stage V](#) for the exhaust after-treatment events.

If an event is only supported by one engine/controller, it is included in the section for that engine/controller.

Engine communication M-Logic events

Event	Description
Engine Fuel Leakage 1 (status)	Activated by the J1939 object <i>EngineFuelLeak1</i>
Engine Wait to Start (status)	Activated by the J1939 object <i>EngineWaitToStart</i>

Event	Description
Engine Protect Sys Shutdown (status)	Activated by the J1939 object <i>EngineProtectSysShutdown</i>
Engine Protect Sys Appro Shutdown (status)	Activated by the J1939 object <i>EngineProtectSysApproShutdown</i>
Engine Alarm Acknowledge (status)	Activated by the J1939 object <i>EngineAlarmAcknowledge</i>
Engine Air Shutoff Command Status (status)	Activated by the J1939 object <i>EngineAirShutoffCommandStatus</i>
Engine Overspeed Test (status)	Activated by the J1939 object <i>EngineOverspeedTest</i>
Engine Shutoff Status (status)	Activated by the J1939 object <i>EngineShutoffStatus</i>

1.7.2 Commands

The following commands are available in M-Logic under *Output, EIC commands*.

See [Tier 4/Stage V](#) for the exhaust after-treatment commands.

If a command is only supported by one engine/controller, it is included in the section for that engine/controller.

Engine communication M-Logic commands

Command	Description
EIC droop	<p>If the droop parameters are enabled in the AGC, the AGC commands the ECU to activate the droop function.</p> <p>Cummins: The AGC sends the droop set point to the ECU. Scania and Volvo Penta: The AGC sends an enable to the ECU.</p>
EIC droop emulation	The AGC uses the droop setting in parameter 2771. The AGC adjusts the speed set point to emulate droop. This is useful if a droop set point cannot be sent to the ECU.
EIC Reset trip fuel	The AGC commands the ECU to reset the trip counter for fuel.
EIC Enable Cylinder Cutout	The ECU is allowed to use cylinder cut-out.
EIC Engine overspeed test	The AGC makes the ECU perform a overspeed test. Instead of raising the RPM, the overspeed alarms limits are lowered.
Inh. EIC alarms	<p>When this command is active, the AGC will not shutdown the engine based on EIC alarms. This is typically necessary while the engine is stopping. The following alarms are inhibited:</p> <ul style="list-style-type: none"> • EIC red alarm • EIC yellow alarm • EIC malfunction • EIC protection
EIC Start/Stop enable	<p>The AGC transmits PGN65223, SPN 786 (2 bits) to control start and stop:</p> <ul style="list-style-type: none"> • Engine start command: The AGC transmits 00: Injection enable • Engine stop command: The AGC transmits 01: Injection disable. <ul style="list-style-type: none"> ◦ The default transmission is 01. <p>The AGC also transmits PGN65223, SPN 3542 (4 bits) to control start and stop:</p> <ul style="list-style-type: none"> • 0000: Normal engine shutdown on engine stop command • 0001: Rapid engine shutdown on engine stop command • 0100: Rapid engine start on engine start command <p>If <i>EIC normal engine start</i> is activated at the same time, the AGC replaces 0100: Rapid engine start with 0011: Normal engine start.</p> <p>Alternatively, you can use <i>EIC Start/Stop</i>, parameter 15090.</p>

Command	Description
EIC Speed Control Inhibit (TSC1)	The AGC will not send a speed set point to the ECU.
EIC Priming on Engine Start	The AGC commands the ECU to activate priming on engine start.
EIC Wait to start inhibit	When this command is active, the AGC does not use the wait to start function.
EIC Inhibit DM1 protection lamp alarm	Inhibits this DM1 alarm.
EIC Inhibit DM1 yellow lamp alarm	Inhibits this DM1 alarm.
EIC Inhibit DM1 red lamp alarm	Inhibits this DM1 alarm.
EIC Inhibit DM1 malfunction lamp alarm	Inhibits this DM1 alarm.

1.7.3 Using Modbus to activate M-Logic commands

You can use Modbus virtual events to activate ECU commands in M-Logic.

Virtual events 1 to 32 can be activated using the discrete output coil (01;05;15) (Modbus addresses 48 to 79) or the holding register (03;06;16) (Modbus addresses 8 to 10).

Virtual events 33 to 96 can only be activated using the discrete output coil (01;05;15) (Modbus addresses 142 to 205).

Example: Virtual event 1 resets the trip counter for fuel

The screenshot shows a configuration window for a logic rule. The title is "Virtual event 1 resets the trip counter for fuel". On the left, there are three event inputs: Event A is checked and set to "Virtual Event 1: Virtual events"; Event B and Event C are unchecked and set to "Not used". In the center, there are two "OR" operator dropdown menus. On the right, there is a "Delay (sec.)" field set to "0", an "Output" dropdown set to "EIC Reset trip fuel: EIC commands", and an "Enable this rule" checkbox that is checked.

1.8 Other

1.8.1 EIC derate

The AGC can derate the engine power by adjusting the set point sent to the ECU. Enable the function using parameter 7551 (EIC Derate).



More information

See the **Designer's Handbook** for more information.

1.8.2 Differential measurement

The AGC can use ECU measurements as analogue inputs in the differential measurement function. The function compares analogue inputs and activates an alarm if the difference drops below the set point.



More information

See the **Designer's Handbook** for more information.

1.8.3 Analogue readings PGN and SPN

Each protocol summary lists the support for selected analogue readings from the ECU. The table below shows the corresponding PGN and SPN values.

External equipment can read all of the supported analogue readings from the AGC Modbus server. Other EIC analogue readings may also be available.

Reading	PGN	SPN
Engine speed	61444	190
Percent load	61443	92
Oil pressure	65263	100
Oil temperature	65262	175
Coolant pressure	65262	109
Coolant temperature	65262	110
Turbo pressure	65270	102
Atmospheric pressure	65269	108
Engine hours	65253	247
Inlet temperature	65270	173
Exhaust temperature	65270	173
Fuel pressure	65263	94
Fuel temperature	65262	174
Water in fuel	65279	97
Fuel consumption/rate (L/h)	65266	183
Fuel used (L)	65257	250
Battery voltage	65271	158
Battery potential (voltage)	65271	168

1.8.4 SPN ignore list

You can select engine communication alarms to ignore using the SPN ignore list available in the utility software under *I/O & Hardware*.

Example: SPN 24 with FMI 16 will be ignored.

The screenshot displays the DEIF utility software interface. On the left is a navigation menu with the DEIF logo at the top. The menu is divided into two sections: 'Monitoring' and 'Configuration'. Under 'Monitoring', there are options for Device, Application supervision, Alarms, Logs, I/O status, and Trending. Under 'Configuration', there are options for Application configuration, Parameters, Advanced Protection, I/O & Hardware setup (which is highlighted with a blue border), and External I/O (CIO).

The main content area shows a configuration window for the 'SPN Ignore list'. At the top, there are tabs for 'Relay output 5 to 21 (STD)', 'Relay output 57 to 63 (M12)', 'AC meas AVG', and 'SPN Ignore list'. Below the tabs is a table with three columns: 'Enable:', 'SPN:', and 'FMI:'. The first row is checked under 'Enable:', has '24' in the 'SPN:' column, and '16 - Above range' in the 'FMI:' column. The remaining eight rows are unchecked, have '0' in the 'SPN:' column, and '0 - Severely above range' in the 'FMI:' column.

Enable:	SPN:	FMI:
<input checked="" type="checkbox"/>	24	16 - Above range
<input type="checkbox"/>	0	0 - Severely above range
<input type="checkbox"/>	0	0 - Severely above range
<input type="checkbox"/>	0	0 - Severely above range
<input type="checkbox"/>	0	0 - Severely above range
<input type="checkbox"/>	0	0 - Severely above range
<input type="checkbox"/>	0	0 - Severely above range
<input type="checkbox"/>	0	0 - Severely above range
<input type="checkbox"/>	0	0 - Severely above range
<input type="checkbox"/>	0	0 - Severely above range

1.8.5 Displaying proprietary text for SPN/FMI combinations

Controllers have the ability to display special proprietary text for certain SPN/FMI combinations.

DM1 used to receive faults

Proprietary text display for SPN/FMI combinations
FPT Stage V
Jichai JC190
JC15D Weifu
Kohler KD62V12
MTU J1939 Smart Connect
PSI/Power Solutions
Volvo Penta EMS2.3
Volvo Penta EMS2.4



Example

Kohler KD62V12 protocol. The display view is the same as generic J1939, but Kohler KD62V12 proprietary text is shown..

```
DG BLOCKED FOR START
SPN:100 FMI:3 OC:0
Intake manifold
Short circuit batter
```

Other

Proprietary text display for SPN/FMI combinations
JC15D WYS



Example

For JC15D WYS, Jichai proprietary telegram is used to receive faults. There are 2 telegrams with 128 bits. Every single bit is an alarm

```
DG BLOCKED FOR START
Alarm 1/32 Index:0
Rail 1 press
Sensor failure
```

2. Generic J1939

2.1 Generic J1939 overview

ECU(s)	Any controller which uses generic J1939		
Engine(s)	Any engine with a generic J1939 controller		
Engine interface protocol (parameter 7561)	Generic J1939		
EIC control			
Start	●		
Stop	●		
Speed control	●		
Default speed control source address	3		
J1939 message	TSC1, CM1, GC1		
Idle mode	●		
50/60 Hz frequency selection	●		
Shutdown override	-		
Diagnostic messages			
DM1 Yellow lamp	●		
DM1 Red lamp	●		
DM1 Protect	●		
DM1 Malfunction	●		
DM2	●		
Emissions			
Tier 4/Stage V	●		
Force regeneration	●		
Inhibit regeneration	●		
Analogue readings*			
Engine speed	●	Inlet temperature	●
Percent load	●	Exhaust temperature	●
Oil pressure	●	Fuel pressure	●
Oil temperature	●	Fuel temperature	●
Coolant pressure	●	Water in fuel	●
Coolant temperature	●	Fuel consumption/rate (L/h)	●
Turbo pressure	●	Fuel used (L)	●
Atmospheric pressure	●	Battery voltage	●
Engine hours	●	Battery potential (voltage)	●

NOTE *External equipment can read all of these from the AGC Modbus server. Other EIC analogue readings may also be available.

2.2 General

2.2.1 Displaying alarms

The display can show J1939 diagnostic messages. You can acknowledge these alarms from the display. Press **OK**, then **Logs**, then select a J1939 log. Use the up and down buttons to scroll through the list.

oc##: The number of times the alarm has occurred.

Selection	Description
DM1	The active alarms.
DM1se	The active alarms from the secondary ECU. This is only shown if a secondary ECU is present.
DM2	The historic alarm log list (since the last clear).

NOTE If the controller has no text for an SPN diagnostic number, *Text N/A* is shown. For information about particular SPN numbers, see the engine manufacturer's documentation. Alternatively, see SAE J1939-71 for a general description.

2.2.2 Write commands

Use parameter 7563 (EIC Controls) to enable write commands.

J1939 write commands

Command	Description
Speed control	To enable speed regulation, select EIC in parameter 2781 (Reg. output GOV). By default, the governor offset is 50 % of the nominal speed. At 0 % it is -120 RPM, and at 100 % it is +120 RPM. The CAN bus ID for speed control is 0xC000003. J1939 TSC1 (transmission rate is 40 ms). You can use M-Logic to disable speed control: <i>Output, EIC commands, EIC Speed Control Inhibit (TSC1)</i> .
Idle speed	The AGC can use speed control to regulate the ECU to run at idle speed (700 RPM). Use parameter 6292 to enable idle speed during engine start up (parameter 6291 is the timer). Use parameter 6294 to enable idle speed when the engine stops (parameter 6293 is the timer).
Start/Stop	This is the standard J1939 command to start the engine if it is stopped, and stops the engine if it is running. The AGC determines whether to start or stop the engine. The decision is based on the AGC's inputs, logic and calculations.
EIC start/stop enable	This is a more advanced function than the standard J1939 Start/Stop commands. See the M-Logic commands for details. If the M-Logic command is enabled, the AGC can also send the standard J1939 start/stop command. The AGC determines whether to start or stop the engine. The decision is based on the AGC's inputs, logic and calculations.
Frequency selection (50 or 60 Hz)	The AGC automatically writes the nominal frequency (50 or 60 Hz) to the ECU. The nominal frequency is defined in parameters 6001, 6011, 6021 and 6031. In general, the AGC uses the frequency to calculate the speed offset in TSC1.
Shutdown override	This command can be used in order to prevent shutdown actions from the ECU. The function is activated by the standard AGC function <i>Shutdown override</i> (digital input on the AGC).

2.2.3 Wait to start

If the ECU supports *Wait to start*, *Preheat* is displayed while the AGC is waiting for the engine to preheat.

You can use M-Logic to prevent wait to start. Activate the M-Logic command *Output*, *EIC commands*, *EIC Wait to start inhibit*.

2.2.4 TSC1 SA Torque Speed Control

Torque Speed Control 1 (TSC1) is the speed control signal from AGC to the ECU. For known protocols, the AGC uses the expected source address when parameter 7566 (TSC1 SA) is **-1** (default value). You can configure parameter 7566 for a specific source address (the range is 0 to 255). You can ask the engine manufacturer to verify the TSC1 source address.

NOTE TSC1 is not used as speed control for all protocols.

NOTE Some protocols do not use TSC1 for idle speed.







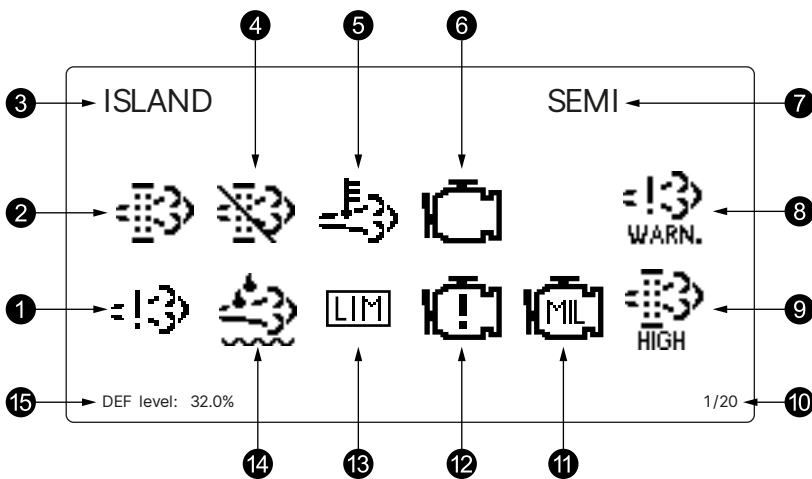



2.2.5 Tier 4/Stage V

The AGC engine communication supports the Tier 4/Stage V requirements. In some countries, Tier 4 after-treatment support must be active during power production.

Tier 4 display screen



No.	Item	Symbol	Notes
1.	Engine emission system failure		Shows an emission failure or malfunction.
2.	Diesel Particle Filter (DPF)		Shows that a regeneration is needed.
3.	Application mode	-	-
4.	Diesel Particle Filter (DPF) Inhibit		Shows that regeneration is inhibited.
5.	High temperature - Regeneration		Shows a high temperature and regeneration is in process.
6.	Engine interface status		Shows an engine warning.
7.	Operation mode	-	-

No.	Item	Symbol	Notes
8.	Engine emission system failure level	  	Shows the severity of an emission failure or malfunction.
9.	Diesel Particle Filter (DPF) level	  	Shows the severity of a needed regeneration.
10.	Page number	-	Shows the number of the View menu screens.
11.	Engine interface status		Indicates a malfunction.
12.	Engine interface status		Shows an engine shutdown.
13.	LIMIT lamp		Only for MTU engines.
14.	Diesel Exhaust Fluid (DEF)		Shows the fluid tank level is low.
15.	Diesel Exhaust Fluid (DEF) % level	-	Shows the level (%) of the Diesel Exhaust Fluid.

NOTE Grey symbols show that communication for the item is available. Not all types of engines support all items shown.

Standard J1939

The AGC receives the standard J1939 Tier 4 information that is available from the ECU. For a list of the Tier 4 information supported by the AGC, see the *EIC measurement* and *EIC state* functions in the *Input register (04)* in the **Modbus tables**.

The AGC sends standard J1939 commands for DM management, and can send commands to inhibit or force regeneration.

Engine-specific information

Depending on the engine, the AGC may support proprietary events and commands. See the engine's description in the **J1939 ECUs and engines** chapter for details.

M-Logic events

A range of Tier 4 operating information is available in M-Logic as events. General Tier 4 events are listed in the following table. Proprietary events are described under the specific engine.

Tier 4 M-Logic events

Event	Description
DPF Lamp OFF	The Diesel Particular Filter does not need regeneration.
DPF Lamp ON (solid)	The Diesel Particular Filter needs regeneration.
DPF Lamp ON (blink)	The Diesel Particular Filter needs regeneration soon.
DPF Active Regeneration not activated (status)	The Diesel Particular Filter is not being regenerated.

Event	Description
DPF Active Regeneration activated (status)	The Diesel Particular Filter is being regenerated.
DPF Active Regeneration needed (status)	The Diesel Particular Filter needs active regeneration.
DPF Regen not needed (status)	The Diesel Particular Filter does not need regeneration.
DPF Regen needed - lowest level (status)	The Diesel Particular Filter needs regeneration, but not urgently.
DPF Regen needed - moderate level (status)	The Diesel Particular Filter needs regeneration soon.
DPF Regen needed - highest level (status)	The Diesel Particular Filter urgently needs regeneration.
DPF Regen not inhibited due to parking brake	The Diesel Particular Filter regeneration is not inhibited due to the parking brake.
DPF Regen inhibited due to parking brake	The Diesel Particular Filter regeneration is inhibited due to the parking brake.
DPF Regen not inhibited due to neutral gear switch	The Diesel Particular Filter regeneration is not inhibited due to the neutral gear switch.
DPF Regen inhibited due to neutral gear switch	The Diesel Particular Filter regeneration is inhibited due to the neutral gear switch.
High Exh Syst Temp OFF (lamp)	The exhaust gas has no high temperature alarm.
High Exh Syst Temp ON (lamp)	The exhaust gas has a high temperature alarm.
DEF Level LOW ICON OFF (lamp)	No active alarm.
DEF Level LOW ICON ON (solid)	Alarm active.
DEF Level LOW ICON ON (blink)	Alarm active (higher severity than solid).
AT Yellow Lamp OFF (status)	No after treatment warning.
AT Yellow Lamp ON (status)	There is an after treatment warning.
AT Red Lamp OFF (status)	No after treatment shutdown.
AT Red Lamp ON (status)	There is an after treatment shutdown.
Safe regeneration (status)	For all protocols that support safe regeneration. The event is active if the command is sent to the ECU.
Water in fuel (SPN 97)	There is water accumulation in the fuel.

M-Logic commands

Some Tier 4 commands are available in M-Logic. General Tier 4 commands are listed in the following table. Proprietary commands are described under the specific engine. This M-logic line works for all protocols supporting safe regeneration.

Tier 4 M-Logic commands

Command	Description
EIC Allow safe regeneration	An additional condition for the AGC safe regeneration command.
EIC DPF Regeneration Inhibit	The AGC commands the ECU to inhibit the regeneration of the Diesel Particulate Filter.
EIC DPF Regeneration Force	The AGC commands the ECU to regenerate the Diesel Particulate Filter.

2.2.6 J1939 measurements

The AGC supports over 200 J1939 measurements. You can use these values as follows:

- **Modbus:** All of the J1939 measurements are available from the AGC Modbus server. The descriptions are in the Modbus tables, in the *Input register* (function code 04), function group *EIC measurement*.
- **Display lines:** Most of the J1939 measurements can be selected for display.
- **Differential measurements:** Key J1939 measurements can be used, for example in parameters 4600-4606.

In addition to the measurements, the AGC Modbus tables can also be used to read over 150 EIC alarms and 70 EIC states.

By default, the engine is expected to use source address **0** (the most commonly used setting on ECUs). If a different source address is required, you can configure it in parameter 7562 (EIC SA/ADEC ID). The range is 0 to 255.

These are some of the J1939 measurements that the AGC supports. Engine communication display values begin with **EIC**. Not all measurements are supported by all engines.

PGN: Parameter group number

S: Object's start byte in the CAN telegram

L: Object's length. By default, the value is in bytes. If the value is in bits, this is specified.

P: J1939 priority

SPN: Suspect parameter number

Unit: Unit in display (bar/°C can be changed to psi/°F)

Text	PGN	S	L	P	SPN	Unit	J1939-71 scaling	Offset
EngineAuxShutdown switch	61441	4.5	2 bits	6	970	0..3	4 states/2 bit	0
EIC acc. pedal pos.	61443	2	1	3/6	91	%	0.4 %/bit	0
EIC % load, c. speed	61443	3	1	3/6	92	%	1 %/bit	0
EIC d.d.% torque	61444	2	1	3/6	512	%	1 %/bit	-125 %
EIC actual % torque	61444	3	1	3/6	513	%	1 %/bit	-125 %
EIC speed	61444	4	2	3/6	190	RPM	0.125 RPM/bit	0
Engine Demand - Torque	61444	8	1	3	2432	%	1 %/bit	-125 %
AT1IntTNOx	61454	1	2	6	3216	ppm	0.05 ppm/bit	-200 ppm
Aftertreatment 1 Intake Oxygen	61454	3	2	6	3217	%	0.000514 %/bit	-12 %
AT1OutLNOx	61455	1	2	6	3226	ppm	0.05 ppm/bit	-200 ppm
Aftertreatment 1 Outlet Oxygen	61455	3	2	6	3227	%	0.000514 %/bit	-12 %
AT2IntTNOx	61456	1	2	6	3255	ppm	0.05 ppm/bit	-200 ppm
Throttle Actuator Control	61466	1	2	4	3464	%	0.0025 %/bit	0
AT2OutLNOx	61457	1	2	6	3265	ppm	0.05 ppm/bit	-200 ppm
AT1ExhFA.DQ	61475	1	2	3	4331	g/h	0.3 g/h per bit	0
AT1ExhFluDAB	61475	6	1	3	4334	kPa	8 kPa/bit	0
AT1ExhFluDRQ	61476	1	2	6	4348	g/h	0.3 g/h per bit	0
AT2ExhFA.DQ	61478	1	2	3	4384	g/h	0.3 g/h per bit	0
AT2ExhFluDAB	61478	6	1	3	4387	kPa	8 kPa/bit	0
AT2ExhFluDRQ	61479	1	2	3	4401	g/h	0.3 g/h per bit	0
Next Regen	64697	1	4	6	5978	s	1 s/bit	

Text	PGN	S	L	P	SPN	Unit	J1939-71 scaling	Offset
Battery Charger 1 State	64788	1.1	4 bits	6	4990	bit	16 states/4 bit	
Battery Charger 1 Power Line State	64788	1.5	2 bits	6	4991	bit	4 states/2 bit	
Battery Charger 1 Output Voltage	64788	2	2	6	4992	V	0.05 V/bit	
Battery Charger 1 Output Current	64788	4	2	6	4993	A	0.05 A/bit	
AT2SCRInG	64824	1	2	6	4413	°C/°F	0.03125 °C/bit	-273 °C
AT2SCRouG	64824	4	2	6	4415	°C/°F	0.03125 °C/bit	-273 °C
AT2ExhFlu DT	64827	3	1	6	4390	°C/°F	1 °C/bit	-40 °C
AT1SCRInG	64830	1	2	5	4360	°C/°F	0.03125 °C/bit	-273 °C
AT1SCRouG	64830	4	2	5	4363	°C/°F	0.03125 °C/bit	-273 °C
AT1ExhFlu DT	64833	3	1	6	4337	°C/°F	1 °C/bit	-40 °C
Long-term Fuel Trim	64841	1	2	6	4237	%	0.1 %/bit	-100 %
Short-term Fuel Trim	64841	3	2	6	4236	%	0.1 %/bit	-100 %
Exhaust Gas Oxygen Sensor Status	64841	5.1	4 bits	6	4240	bit	16 states/4 bit	0
AT1ExhAvrCons	64878	1	2	6	3826	l/h	0.05 l/h per bit	0
EngOperatingState	64914	1.1	4 bits	3	3543	0..15	16 states/4 bit	0
Engine Derate Request	64914	8	1	3	3644	%	0.4 %/bit	0
EngineAT1RegenerationStatus, MLogic	64929	7.5	2 bits	6	3483	0..3	4 states/2 bit	0
DPF OUTL T	64947	3	2	6	3246	°C/°F	0.03125 °C/bit	-273 °C
EIC Air filter diff. pressure	64976	1	1	6	2809	bar/psi	0.05 kPa	0
EIC Intake manifold #1 absolute pressure	64976	5	1	6	3563	bar/psi	2 kPa/bit	
Sp.Humidity	64992	3	2	6	4490	g/kg	0.01 g/kg per bit	0
EIC Exhaust gas temp. R manifold	65031	1	2	6	2433	°C/°F	0.03125 °C/bit	-273 °C
EIC Exhaust gas temp. L manifold	65031	3	2	6	2434	°C/°F	0.03125 °C/bit	-273 °C
DEF LEVEL	65110	1	1	6	1761	%	0.4 %/bit	0
AT1ExhFluTank deg	65110	2	1	6	3031	°C/°F	1 °C/bit	-40 °C
bScrOprInducementActiveLamp, MLogic	65110	5.6	3 bits	6	5245	0 to 7	8 states/3 bit	0
SCR IND. SEV.	65110	6.6	3 bits	6	5246	0 to 7	8 states/3 bit	0
No view, for Coolant water regulation	65129	3	2	6	1637	°C/°F	0.03125 °C/bit	-273 °C
EIC Fuel supply pump inlet pressure	65130	2	1	6	1381	bar/psi	2 kPa/bit	0
EIC Fuel filter (ss) diff. pressure	65130	3	1	6	1382	bar/psi	2 kPa/bit	0
Engine Desired Ignition Timing	65159	1	2	7	1433	deg	1/128 deg/bit	-200 deg
Engine Actual Ignition Timing	65159	7	2	7	1436	deg	1/128 deg/bit	-200 deg
EngineFuelLeak1, MLogic	65169	1	2	7	1239	bit	00 no leakage detect. 01 leakage detect.	
AuxCool Pr.	65172	1	1	6	1203	kPa	4 kPa/bit gain, 0 kPa offset	
T. Cool Aux	65172	2	1	6	1212	°C/°F	1 °C/bit gain	-40 °C
Tcharger 2	65179	2	2	7	1169	RPM	4 RPM/bit gain	0 RPM

Text	PGN	S	L	P	SPN	Unit	J1939-71 scaling	Offset
Tcharger 3	65179	4	2	7	1170	RPM	4 RPM/bit gain	0 RPM
T-ECU	65188	3	2	6	1136	°C/°F	0.03125 °C/bit gain	-273 °C
Intake Man T2	65189	1	1	7	1131	°C/°F	1 °C/bit gain	-40 °C
EIC trip fuel gaseous	65199	1	4	7	1039	kg	0.5 kg/bit,	0
EIC total fuel used gaseous	65199	5	4	7	1040	kg	0.5 kg/bit	0
EIC Mean trip fuel consumption	65203	5	2	7	1029	l/h	0,05 [l/h]/bit	
Est. Fan RPM	65213	1	1	6	975	%	0.4 %/bit gain	0 %
EIC Nominal Power	65214	1	2	7	166	kW	0.5 kW/bit	
Diagnostic message 1/2	65226	-	-	3/6/7	-	-	-	
EIC faults	65230	1	1	6	1218	-	1/bit	0
Number of Software Identification Fields	65242	1	1	6	965	step	1 count/bit	0
Software Identification	65242	2	Variable	6	234	SCII	ASCII	0
Tcharger 1	65245	2	2	6	103	RPM	4 RPM/bit gain	0 RPM
Nom. Friction	65247	1	1	6	514	%	1 %/bit gain	-125 %
Desired	65247	2	2	6	515	RPM	0.125 RPM/bit gain	0 RPM
EngineWaitToStart, MLogic	65252	4.1	2 bits	6	1081	bit	00 off 01 on	
EngineProtectSysShutdown, MLogic	65252	5.1	2 bits	6	1110	bit	00 yes 01 no	
EngineProtectSysApproShutdown, MLogic	65252	5.3	2	6	1109	bit	00 not approaching 01 approaching	
EngineAlarmAcknowledge, MLogic	65252	7.1	2 bits	6	2815	0..3	4 states/2 bit	0
EngineAirShutoffCommandStatus, MLogic	65252	7.5	2 bits	6	2813	0..3	4 states/2 bit	0
EngineOverspeedTest, MLogic	65252	7.7	2 bits	6	2812	0..3	4 states/2 bit	0
EngineShutoffStatus, MLogic	65252	8.3	2 bits	6	5404	0..3	4 states/2 bit	0
EIC engine hours	65253	1	4	3/6	247	h	0.05 hrs/bit, max: 32767 hrs	0
EIC engine trip fuel	65257	1	4	6	182	L	0.5 L/bit	0
EIC engine total fuel used	65257	5	4	6	250	L	0.5 L/bit	0
EIC coolant temp.	65262	1	1	3/6	110	°C/°F	1 °C/bit	-40 °C
EIC fuel temp.	65262	2	1	3/6	174	°C/°F	1 °C/bit	-40 °C
EIC oil temp.	65262	3	2	3/6	175	°C/°F	0.03125 °C/bit	-273 °C
EIC turbo oil temp.	65262	5	2	3/6	176	°C/°F	0.03125 °C/bit	-273 °C
EIC Intercooler temperature	65262	7	1	3/6	52	°C/°F	1 °C/bit	-40 °C
EIC fuel del. press.	65263	1	1	6	94	bar/psi	4 kPa/bit,	0
EIC oil level	65263	3	1	6	98	%	0.4 %/bit	0
EIC oil pressure	65263	4	1	6	100	bar/psi	4 kPa/bit	0
EIC crankcase press.	65263	5	2	6	101	bar/psi	1/128 kPa/bit,	-250 kPa
EIC coolant pressure	65263	7	1	6	109	bar/psi	2 kPa/bit,	0

Text	PGN	S	L	P	SPN	Unit	J1939-71 scaling	Offset
EIC coolant level	65263	8	1	6	111	%	0.4 %/bit	0
EIC fuel rate	65266	1	2	6	183	l/h	0.05 l/h per bit	0
EIC atmospheric press.	65269	1	1	6	108	bar/psi	0.5 kPa/bit	0
EIC ambient air temp.	65269	4	2	6	171	°C/°F	0.03125 °C/bit	-273 °C
EIC air inlet temp.	65269	6	1	6	172	°C/°F	1 °C/bit	-40 °C
EIC particulate trap inlet	65270	1	1	6	81	bar/psi	0.5 kPa/bit	0
EIC intake manifold #1 P. (EIC boost P)	65270	2	1	6	102	bar/psi	2 kPa/bit	0
EIC intake manifold 1 temp. (EIC charge air temp)	65270	3	1	6	105	°C/°F	1 °C/bit	-40 °C
EIC air inlet pressure	65270	4	1	6	106	bar/psi	2 kPa/bit	0
EIC air filter diff.	65270	5	1	6	107	bar/psi	0.05 kPa/bit	0
EIC exhaust gas temp.	65270	6	2	6	173	°C/°F	0.03125 °C/bit	-273 °C
EIC coolant filter diff.	65270	8	1	6	112	bar/psi	0.5 kPa/bit	0
EIC key switch battery potential	65271	7	2	6	158	V DC	0.05 V DC/bit	0
EIC Fuel filter diff. pressure	65276	3	1	3/6	95	bar/psi	2 kPa/bit	0
EIC oil filter diff. press.	65276	4	1	3/6	99	bar/psi	0.5 kPa/bit	0
EIC water in. fuel	65279	1	2	6	97	-	00: No, 01: Yes, 10: Error, 11: Not available	
ENG CAC T	64617	7	2	6	2630	°C/°F	0.03125 °C/bit	-273 °C
DPF Soot Load	64891	1	1	6	3719	%	1 %/bit	0



More information

See **Modbus analogue values** for Modbus scaling.

Error messages

The following error messages can occur:

Message	Description
Engine I. value N.A.	The view is not selectable for the present engine type.
Value selected error	The value cannot be read due to sensor error, sub-system or module error.
N.A.	The value is not supported by the engine, or due to communication error.

2.2.7 Modbus alarms

The EIC alarms activated in the AGC can be seen in the **Modbus tables**, in the *Input register* (function code 04), under Modbus address 1020.

Specific EIC alarms for J1939

Addr.	Content	Bit	Type
1024	EIC alarms, engine controller (DM1)	0	EIC communication error
		1	EIC yellow
		2	EIC red
		3	EIC protection
		4	EIC malfunction

2.2.8 Modbus analogue values

All the engine readings are available from the Modbus server. See the **Modbus tables** for details. The data available depends on the specific engine. Refer to the engine manual.

2.3 J1939/75

When an engine protocol is selected in parameter 7561 and parameter 7552 is *JCB Livelink*, the AGC sends J1939/75 data. Other systems (including JCB LiveLink) can use this data.

Standard data over J1939/75

The AGC sends the following standard J1939/75 data. The scaling, units, start bit, length, offset, minimum, maximum, and update rate follow the standard.

PGN	SPN	Instrument	Notes
0xFE06	0x988	Generator Average Line Line AC RMS Voltage	The AGC sends the standard shutdown high, shutdown low, warning high and warning low.
0xFE06	0x98C	Generator Average Line Neutral AC RMS Voltage	The AGC sends the standard shutdown high, shutdown low, warning high and warning low.
0xFE06	0x984	Generator Average AC Frequency	The AGC sends the standard shutdown high, shutdown low, warning high and warning low.
0xFE06	0x990	Generator Average AC RMS Current	The AGC sends the standard shutdown high and warning high.
0xFE03	0x989	Generator Phase A Line Line AC RMS Voltage	
0xFE03	0x98D	Generator Phase A Line Neutral AC RMS Voltage	
0xFE03	0x985	Generator Phase A AC Frequency	
0xFE03	0x991	Generator Phase A AC RMS Current	
0xFE02	0x995	Generator Phase A Real Power	
0xFE02	0x99D	Generator Phase A Apparent Power	
0xFE01	0x999	Generator Phase A Reactive Power	
0xFE00	0x98A	Generator Phase B Line Line AC RMS Voltage	
0xFE00	0x98E	Generator Phase B Line Neutral AC RMS Voltage	
0xFE00	0x986	Generator Phase B AC Frequency	
0xFE00	0x992	Generator Phase B AC RMS Current	
0xFDFD	0x996	Generator Phase B Real Power	
0xFDFD	0x99E	Generator Phase B Apparent Power	
0xFDFE	0x99A	Generator Phase B Reactive Power	
0xFDFD	0x98B	Generator Phase C Line Line AC RMS Voltage	

PGN	SPN	Instrument	Notes
0xFDFD	0x98F	Generator Phase C Line Neutral AC RMS Voltage	
0xFDFD	0x987	Generator Phase C AC Frequency	
0xFDFD	0x993	Generator Phase C AC RMS Current	
0xFDFC	0x997	Generator Phase C Real Power	
0xFDFC	0x99F	Generator Phase C Apparent Power	
0xFDFB	0x99B	Generator Phase C Reactive Power	
0xFDFA	0x9A4	Generator Accumulated Energy Export (kWh)	
0xFD8E	0xE09	Generator Accumulated Energy Export (kVArh)	
0xFE05	0x994	Generator Total Real Power	
0xFE05	0x99C	Generator Total Apparent Power	
0xFE04	0x998	Generator Total Reactive Power	
0xFE04	0x9A0	Generator Overall Power Factor	
0xFE04	0x9D6	Generator Overall Power Factor Lagging	
0xF004	0xBE	ENGINE_SPEED	The AGC sends the standard shutdown high, shutdown low, warning high and warning low.
0xFEEF	0x64	Oil Pressure	The AGC sends the standard shutdown high, shutdown low, warning high, warning low and fault sensor.
0xFEEE	0x6E	COOLANT_T	The AGC sends the standard shutdown high, shutdown low, warning high, warning low and fault sensor.
0xFEFC	0x60	Fuel Level 1	The AGC sends the standard shutdown high, shutdown low, warning high and warning low.
0xFE77	0x9E	Charge Alternator System Potential	The AGC does not send the standard shutdown low and warning low.
0xFE77	0xA8	Battery Potential	The AGC sends the standard shutdown high, shutdown low, warning high and warning low.
0xFD92	0xE17	Emergency Shutdown Indication	
0xFEE5	0xF0	ENGINE_HOURS	
0xFEBE	0xE57	CRANK_ATTEMPTS	
0xFEFC	0x26	Fuel Level 2	

NOTE If you need the AGC to send additional J1939/75 data, please contact DEIF.

2.3.1 J1939/75 DM1s

The AGC can send DM1s when these alarms are activated.

AGC alarms

Parameter	Name	SPN	FMI 0 Shutdown high	FMI 1 Shutdown low	FMI 15 Warning high	FMI 17 Warning low
1470	P> 3	2452				●
4520*	Overspeed 2	190	●		●	
4590*	Underspeed 1	190		●		●

Parameter	Name	SPN	FMI 0 Shutdown high	FMI 1 Shutdown low	FMI 15 Warning high	FMI 17 Warning low
4960	U< aux. term 1	168		●		●
4970	U> aux. term 1	168	●		●	
7600**	EIC Overspeed	190	●		●	
14000	Avg G U> L-L 1	2440			●	
14010	Avg G U> L-L 2	2440	●			
14020	Avg G U< L-L 1	2440				●
14030	Avg G U< L-L 2	2440		●		
14040	Avg G U> L-N 1	2444			●	
14050	Avg G U> L-N 2	2444	●			
14060	Avg G U< L-N 1	2444				●
14070	Avg G U< L-N 2	2444		●		
14080	Avg G f> 1	2436			●	
14090	Avg G f> 2	2436	●			
14100	Avg G f< 1	2436				●
14110	Avg G f< 2	2436		●		
14120	Avg l> 1	2448			●	
14130	Avg l> 2	2448	●			

NOTE The AGC alarm fail class determines which FMI is used.

NOTE * EIC overspeed not enabled.

NOTE ** EIC overspeed enabled.

Multi-input alarms

Parameter	Name	SPN	FMI 0 Shutdown high	FMI 1 Shutdown low	FMI 15 Warning high	FMI 17 Warning low
15022	Livelink Fuel 1	96	●	●	●	●
15023	Livelink Fuel 2	38	●	●	●	●
15024	Livelink Oil press	100*	●	●	●	●
15025	Livelink Coolant	110**	●	●	●	●

NOTE For the multi-inputs, for J1939/75 DM1s, alarm 1 is always for warning, and alarm 2 is for shutdown. For Pt100, both alarm 1 and alarm 2 are for warning.

NOTE * Wirebreak alarms are possible (FMI 2).

NOTE ** Wirebreak alarms are possible (FMI 2).

2.4 Troubleshooting

2.4.1 Diagnostic codes

The J1939 diagnostic codes can be read using Modbus, function code 04. For more information, see the AGC **Modbus tables**.

An alarm diagnostic code is a combination of 3 values:

1. **SPN** = Suspect Parameter Number: The value that the alarm is based on. Since SPN numbers can be quite big, the SPN number is read with a combination of Low [LO] word and High [HI] word in the Modbus lists.
2. **FMI** = Failure Mode Indicator: The alarm severity.

3. **OC** = Occurrence Counter: How many times the alarm has occurred.



High coolant temperature shutdown example

SPN code is **110**: The coolant temperature.
 FMI code is **0**: The most severe high level alarm (shutdown).
 OC code is **2**: The second time the alarm appears.

The diagnostic codes can also be seen in the display, in the J1939 alarm logs.

To interpret an SPN and/or FMI number, see the documentation of the engine manufacturer.

The tables below show the combination of SPN, FMI and OC codes for each alarm.

There are 10 alarm combinations for active alarms (DM1) and 10 for historical alarms (DM2).

The lists are *first-in-first-out*. This means that alarm 1 is always the latest alarm. When a new alarm appears, alarm 10 is pushed off of the list. The previous alarm 9 is now alarm 10, and so on.

Active Alarms (DM1)

Alarm	Modbus addresses			
	SPN (Suspect Parameter Number)		FMI (Failure Mode Identifier)	OC (Occurrence Counter)
	LO word	HI word		
1	1370	1380	1402	1418
2	1371	1381	1403	1419
3	1372	1382	1404	1420
4	1373	1383	1405	1421
5	1374	1384	1406	1422
6	1375	1385	1407	1423
7	1376	1386	1408	1424
8	1377	1387	1409	1425
9	1378	1388	1410	1426
10	1379	1389	1411	1427

Historical Alarms (DM2)

Alarm	Modbus addresses			
	SPN (Suspect Parameter Number)		FMI (Failure Mode Identifier)	OC (Occurrence Counter)
	LO word	HI word		
1	1434	1444	1466	1482
2	1435	1445	1467	1483
3	1436	1446	1468	1484
4	1437	1447	1469	1485
5	1438	1448	1470	1486
6	1439	1449	1471	1487

Alarm	Modbus addresses			
	SPN (Suspect Parameter Number)		FMI (Failure Mode Identifier)	OC (Occurrence Counter)
	LO word	HI word		
7	1440	1450	1472	1488
8	1441	1451	1473	1489
9	1442	1452	1474	1490
10	1443	1453	1475	1491

2.4.2 Troubleshooting the CAN bus connection

Troubleshooting the CAN bus connection is not normally necessary. When you connect the AGC CAN bus terminals to an ECU that follows the J1939 standard, communication starts without needing any other actions.

If required, you can use a CAN bus sniffer with CAN PC software to verify the communication between the ECU and the AGC. The CAN bus sniffer must be connected to the CAN bus wiring. Refer to the CAN bus sniffer and CAN PC software documentation for more information.

As an example, see the following telegram:

0xCF00400 FF 7D 7D E0 15 FF F0 FF

DATA BYTE: 1 2 3 4 5 6 7 8

- 0xC is the priority (12)
- F004 is the PGN number (61444)
- The 8 bytes following the CAN ID (**0xCF00400**) are data, starting with byte 1

The priority bits need to be converted to decimal, then divided by 4 to calculate the priority.

0xC = 12 ⇒ Priority 3

NOTE The 3 priority bits here are in the CAN ID (that is, 0xCF00400, instead of 0x0CF00400). Another example: 0x18FEF200 (PGN 65266).

Priority	Decimal ID	Hexadecimal ID
1	4	0x4
2	8	0x8
3	12	0xC
4	16	0x10
5	20	0x14
6	24	0x18
7	28	0x1C

In SAE J1939, normally only priority 3 and 6 are used.

Hereafter the data can be read (PGN 61444):

0xCF00400 xD FF 7D 7D E0 15 FF F0 FF

	Byte	Value	Note
Engine torque	1	0xFF	Not available
Driver demand torque	2	0x7D	
Actual engine torque	3	0x7D	
Engine speed	4	0xE0	
Engine speed	5	0x15	
Source address	6	0xFF	Not available
Engine starter mode	7	0xF0	
Engine Demand	8	0xFF	Not available

Calculation example: RPM resolution is 0.125 RPM/bit, offset 0.

The result is then $0 \times 15E0 (5600) \times 0.125 = 700 \text{ RPM}$.

3. J1939 ECUs and engines

3.1 ANGLE

3.1.1 ANGLE

ECU(s)			
Engine(s)			
Engine interface protocol (parameter 7561)	ANGLE		
EIC control			
Start	●		
Stop	●		
Speed control	●		
Default speed control source address	3		
J1939 message	TSC1, CM1, GC1		
Idle mode	●		
50/60 Hz frequency selection	●		
Shutdown override	-		
Proprietary message(s)	-		
Diagnostic messages			
DM1 Yellow lamp	●		
DM1 Red lamp	●		
DM1 Protect	●		
DM1 Malfunction	●		
DM2	●		
Emissions			
Tier 4/Stage V	●		
Force regeneration	●		
Inhibit regeneration	●		
Analogue readings*			
Engine speed	●	Inlet temperature	●
Percent load	●	Exhaust temperature	
Oil pressure	●	Fuel pressure	●
Oil temperature	●	Fuel temperature	●
Coolant pressure	●	Water in fuel	
Coolant temperature	●	Fuel consumption/rate (L/h)	●
Turbo pressure	●	Fuel used (L)	●
Atmospheric pressure	●	Battery voltage	●
Engine hours	●	Battery potential (voltage)	●

NOTE *External equipment can read all of these from the AGC Modbus server. Other EIC analogue readings may also be available.

3.2 Baudouin

3.2.1 Baudouin Wise10B

ECU(s)	Wise 10B		
Engine(s)	Diesel		
Engine interface protocol (parameter 7561)	Baudouin Wise10B		
EIC control			
Start	-		
Stop	-		
Speed control	●		
Default speed control source address	3		
J1939 message	TSC1		
Idle mode	●		
50/60 Hz frequency selection	●		
Shutdown override	-		
Proprietary message(s)	-		
Diagnostic messages			
DM1 Yellow lamp	●		
DM1 Red lamp	●		
DM1 Protect	●		
DM1 Malfunction	●		
DM2	●		
Emissions			
Tier 4/Stage V	-		
Force regeneration	-		
Inhibit regeneration	-		
Analogue readings*			
Engine speed	●	Inlet temperature	-
Percent load	-	Exhaust temperature	-
Oil pressure	●	Fuel pressure	-
Oil temperature	●	Fuel temperature	●
Coolant pressure	-	Water in fuel	-
Coolant temperature	●	Fuel consumption/rate (L/h)	●
Turbo pressure	●	Fuel used (L)	●
Atmospheric pressure	-	Battery voltage	-
Engine hours	-	Battery potential (voltage)	-

NOTE *External equipment can read all of these from the AGC Modbus server. Other EIC analogue readings may also be available.

3.2.2 Baudouin Wise 15

ECU(s)	Wise 15		
Engine(s)			
Engine interface protocol (parameter 7561)	Baudouin Wise15		
EIC control			
Start	-		
Stop	-		
Speed control	●		
Default speed control source address	3		
J1939 message	TSC1		
Idle mode	●		
50/60 Hz frequency selection	●		
Shutdown override	-		
Proprietary message(s)	-		
Diagnostic messages			
DM1 Yellow lamp	●		
DM1 Red lamp	●		
DM1 Protect	●		
DM1 Malfunction	●		
DM2	●		
Emissions			
Tier 4/Stage V	●		
Force regeneration	-		
Inhibit regeneration	-		
Analogue readings*			
Engine speed	●	Inlet temperature	-
Percent load	●	Exhaust temperature	●
Oil pressure	●	Fuel pressure	-
Oil temperature	●	Fuel temperature	●
Coolant pressure	-	Water in fuel	●
Coolant temperature	●	Fuel consumption/rate (L/h)	●
Turbo pressure	●	Fuel used (L)	●
Atmospheric pressure	-	Battery voltage	●
Engine hours	●	Battery potential (voltage)	●

NOTE *External equipment can read all of these from the AGC Modbus server. Other EIC analogue readings may also be available.

3.2.3 Baudouin Gas

ECU(s)	WOODWARD PG+		
Engine(s)	Gas		
Engine interface protocol (parameter 7561)	Baudouin Gas		
EIC control			
Start	-		
Stop	-		
Speed control	●		
Default speed control source address	3		
J1939 message	TSC1		
Idle mode	●		
50/60 Hz frequency selection	●		
Shutdown override	-		
Proprietary message(s)	-		
Diagnostic messages			
DM1 Yellow lamp	●		
DM1 Red lamp	●		
DM1 Protect	●		
DM1 Malfunction	●		
DM2	●		
Emissions			
Tier 4/Stage V	-		
Force regeneration	-		
Inhibit regeneration	-		
Analogue readings*			
Engine speed	●	Inlet temperature	-
Percent load	-	Exhaust temperature	-
Oil pressure	●	Fuel pressure	-
Oil temperature	●	Fuel temperature	●
Coolant pressure	-	Water in fuel	-
Coolant temperature	●	Fuel consumption/rate (L/h)	●
Turbo pressure	●	Fuel used (L)	●
Atmospheric pressure	-	Battery voltage	-
Engine hours	-	Battery potential (voltage)	-

NOTE *External equipment can read all of these from the AGC Modbus server. Other EIC analogue readings may also be available.

3.2.4 Warnings and shutdowns

Warning and shutdown list	J1939 codes		
	SPN	FMI warning	FMI shutdown
Low oil pressure	100	18	1
Intake manifold	105	16	-
Coolant temperature	110	16	0
Fuel injection pump	1076	10	6
Fuel temperature	174	-	16
ECU failure	2000	-	6

NOTE If FMI is "-" the alarm is not supported.

3.2.5 Write commands

Use parameter 7563 (EIC Controls) to enable write commands.

Moteurs Baudouin write command

Command	Description
Speed control	In general, this is the same as the J1939 command .

3.3 Bosch

3.3.1 Bosch EDC17

ECU(s)	EDC17		
Engine(s)			
Engine interface protocol (parameter 7561)	Bosch EDC17CV54TMTL		
EIC control			
Start	●		
Stop	●		
Speed control	●		
Default speed control source address	3		
J1939 message	TSC1, CM1, GC1		
Idle mode	●		
50/60 Hz frequency selection	●		
Shutdown override	-		
Diagnostic messages			
DM1 Yellow lamp	●		
DM1 Red lamp	●		
DM1 Protect	●		
DM1 Malfunction	●		
DM2	●		
Emissions			
Tier 4/Stage V	●		
Force regeneration	●		
Inhibit regeneration	●		
Analogue readings*			
Engine speed	●	Inlet temperature	●
Percent load	●	Exhaust temperature	●
Oil pressure	●	Fuel pressure	●
Oil temperature	●	Fuel temperature	●
Coolant pressure	●	Water in fuel	●
Coolant temperature	●	Fuel consumption/rate (L/h)	●
Turbo pressure	●	Fuel used (L)	●
Atmospheric pressure	●	Battery voltage	●
Engine hours	●	Battery potential (voltage)	●

NOTE *External equipment can read all of these from the AGC Modbus server. Other EIC analogue readings may also be available.

3.4 Caterpillar

3.4.1 Caterpillar ADEM3

ECU(s)	ADEM3		
Engine(s)	C4.4, C6.6, C9, C15, C18, C32, 3500, 3600		
Engine interface protocol (parameter 7561)	Caterpillar ADEM3		
EIC control			
Start	●		
Stop	●		
Speed control	●		
Default speed control source address	0		
J1939 message	TSC1		
Idle mode	●		
50/60 Hz frequency selection	●		
Shutdown override	-		
Proprietary message(s)	Heartbeat		
Diagnostic messages			
DM1 Yellow lamp	●		
DM1 Red lamp	●		
DM1 Protect	●		
DM1 Malfunction	●		
DM2	-		
Emissions			
Tier 4/Stage V	-		
Force regeneration	-		
Inhibit regeneration	-		
Analogue readings*			
Engine speed	●	Inlet temperature	-
Percent load	●	Exhaust temperature	-
Oil pressure	●	Fuel pressure	●
Oil temperature	-	Fuel temperature	●
Coolant pressure	-	Water in fuel	-
Coolant temperature	●	Fuel consumption/rate (L/h)	●
Turbo pressure	●	Fuel used (L)	●
Atmospheric pressure	-	Battery voltage	●
Engine hours	●	Battery potential (voltage)	●

NOTE *External equipment can read all of these from the AGC Modbus server. Other EIC analogue readings may also be available.

General

DM1se: The secondary DM1 logs shows alarms from the EMCP 3.x genset controller.

EIC RelativeHumidity alarm (menu 15060): You can configure a relative humidity alarm (range -100 to 100 %, default is 50 %), with a delay of 0 to 100 s (default is 5 s).

Other: The AGC sends a "heartbeat" telegram (broadcast PGN 61688 globally (255)) every second. This prevents a communication warning from the ECU.

3.4.2 Caterpillar ADEM4

ECU(s)	ADEM4		
Engine(s)	C4.4, C6.6, C9, C15, C18, C32, 3500, 3600		
Engine interface protocol (parameter 7561)	Caterpillar ADEM4		
EIC control			
Start	●		
Stop	●		
Speed control	●		
Default speed control source address	0		
J1939 message	TSC1		
Idle mode	●		
50/60 Hz frequency selection	●		
Shutdown override	-		
Proprietary message(s)	Heartbeat		
Diagnostic messages			
DM1 Yellow lamp	●		
DM1 Red lamp	●		
DM1 Protect	●		
DM1 Malfunction	●		
DM2	-		
Emissions			
Tier 4/Stage V	-		
Force regeneration	-		
Inhibit regeneration	-		
Analogue readings*			
Engine speed	●	Inlet temperature	-
Percent load	●	Exhaust temperature	-
Oil pressure	●	Fuel pressure	●
Oil temperature	-	Fuel temperature	●
Coolant pressure	-	Water in fuel	-
Coolant temperature	●	Fuel consumption/rate (L/h)	●
Turbo pressure	●	Fuel used (L)	●
Atmospheric pressure	-	Battery voltage	●
Engine hours	●	Battery potential (voltage)	●

NOTE *External equipment can read all of these from the AGC Modbus server. Other EIC analogue readings may also be available.

General

DM1se: The secondary DM1 logs shows alarms from the EMCP 3.x genset controller.

EIC RelativeHumidity alarm (menu 15060): You can configure a relative humidity alarm (range -100 to 100 %, default is 50 %), with a delay of 0 to 100 s (default is 5 s).

Other: The AGC sends a "heartbeat" telegram (broadcast PGN 61688 globally (255)) every second. This prevents a communication warning from the ECU.

3.4.3 Caterpillar ADEM6

ECU(s)	ADEM6		
Engine(s)	C4.4, C6.6, C9, C15, C18, C32, 3500, 3600		
Engine interface protocol (parameter 7561)	Caterpillar ADEM6		
EIC control			
Start	●		
Stop	●		
Speed control	●		
Default speed control source address	3		
J1939 message	TSC1, CM1, EBC1, CM2		
Idle mode	●		
50/60 Hz frequency selection	●		
Shutdown override			
Proprietary message(s)			
Diagnostic messages			
DM1 Yellow lamp	●		
DM1 Red lamp	●		
DM1 Protect	●		
DM1 Malfunction	●		
DM2	●		
Emissions			
Tier 4/Stage V	●		
Force regeneration	●		
Inhibit regeneration	●		
Analogue readings*			
Engine speed	●	Inlet temperature	●
Percent load	●	Exhaust temperature	
Oil pressure	●	Fuel pressure	●
Oil temperature		Fuel temperature	●
Coolant pressure		Water in fuel	
Coolant temperature	●	Fuel consumption/rate (L/h)	●
Turbo pressure	●	Fuel used (L)	●
Atmospheric pressure	●	Battery voltage	●
Engine hours	●	Battery potential (voltage)	●

NOTE *External equipment can read all of these from the AGC Modbus server. Other EIC analogue readings may also be available.

General

DM1se: The secondary DM1 logs shows alarms from the EMCP 3.x genset controller.

EIC RelativeHumidity alarm (menu 15060): You can configure a relative humidity alarm (range -100 to 100 %, default is 50 %), with a delay of 0 to 100 s (default is 5 s).

Other: The AGC sends a "heartbeat" telegram (broadcast PGN 61688 globally (255)) every second. This prevents a communication warning from the ECU.

3.4.4 Caterpillar Generic

ECU(s)	ADEM3, ADEM4		
Engine(s)	C4.4, C6.6, C9, C15, C18, C32, 3500, 3600		
Engine interface protocol (parameter 7561)	Caterpillar Generic		
EIC control			
Start	●		
Stop	●		
Speed control	●		
Default speed control source address	0		
J1939 message	TSC1		
Idle mode	●		
50/60 Hz frequency selection	●		
Shutdown override	-		
Proprietary message(s)	Heartbeat		
Diagnostic messages			
DM1 Yellow lamp	●		
DM1 Red lamp	●		
DM1 Protect	●		
DM1 Malfunction	●		
DM2	-		
Emissions			
Tier 4/Stage V	-		
Force regeneration	-		
Inhibit regeneration	-		
Analogue readings*			
Engine speed	●	Inlet temperature	-
Percent load	●	Exhaust temperature	-
Oil pressure	●	Fuel pressure	●
Oil temperature	-	Fuel temperature	●
Coolant pressure	-	Water in fuel	-
Coolant temperature	●	Fuel consumption/rate (L/h)	●
Turbo pressure	●	Fuel used (L)	●

Atmospheric pressure	-	Battery voltage	●
Engine hours	●	Battery potential (voltage)	●

NOTE *External equipment can read all of these from the AGC Modbus server. Other EIC analogue readings may also be available.

General

DM1se: The secondary DM1 logs shows alarms from the EMCP 3.x genset controller.

EIC RelativeHumidity alarm (menu 15060): You can configure a relative humidity alarm (range -100 to 100 %, default is 50 %), with a delay of 0 to 100 s (default is 5 s).

Other: The AGC sends a "heartbeat" telegram (broadcast PGN 61688 globally (255)) every second. This prevents a communication warning from the ECU.

3.4.5 Warnings and shutdowns

Warning and shutdown list	J1939 codes		
	SPN	FMI warning	FMI shutdown
Low oil pressure	100	17	1
Intake manifold #1 P	102	15	-
Coolant temperature	110	15	1
High inlet air temp.	172	15	-
Fuel temperature	174	15	-
Overspeed	190	15	0

NOTE If FMI is "-" the alarm is not supported.

3.4.6 Display texts

J1939 name	Display text
Engine Exhaust Gas Port 1 Temperature	Exh.P T01
Engine Exhaust Gas Port 2 Temperature	Exh.P T02
Engine Exhaust Gas Port 3 Temperature	Exh.P T03
Engine Exhaust Gas Port 4 Temperature	Exh.P T04
Engine Exhaust Gas Port 5 Temperature	Exh.P T05
Engine Exhaust Gas Port 6 Temperature	Exh.P T06
Engine Exhaust Gas Port 7 Temperature	Exh.P T07
Engine Exhaust Gas Port 8 Temperature	Exh.P T08
Engine Exhaust Gas Port 9 Temperature	Exh.P T09
Engine Exhaust Gas Port 10 Temperature	Exh.P T10
Engine Exhaust Gas Port 11 Temperature	Exh.P T11
Engine Exhaust Gas Port 12 Temperature	Exh.P T12
Engine Exhaust Gas Port 13 Temperature	Exh.P T13
Engine Exhaust Gas Port 14 Temperature	Exh.P T14
Engine Exhaust Gas Port 15 Temperature	Exh.P T15
Engine Exhaust Gas Port 16 Temperature	Exh.P T16
Engine Coolant Temperature 2	T. Coolant2

J1939 name	Display text
Engine Coolant Temperature 3	T. Coolant3
Engine Coolant Pump Outlet Temperature	T. Cool PO
Engine Filtered Fuel Delivery Pressure	P. FilFuel
Engine Auxiliary Coolant Temperature	T. Cool Aux
Engine Turbocharger 1 Turbine Intake Temperature	Turb.int1
Engine Turbocharger 2 Turbine Intake Temperature	Turb.int2

3.4.7 Write commands

Use parameter 7563 (EIC Controls) to enable write commands.

Caterpillar write commands

Command	Description
Speed control	In general, this is the same as the J1939 command . J1939 TSC1 transmission rate is 20 ms.
Idle speed	See the J1939 command .
Start/Stop	See the J1939 command .
EIC start/stop enable	See the J1939 command .

3.4.8 M-Logic (Caterpillar ADEM6)

Command

The following additional command is available in M-Logic under *Output, EIC commands* for Caterpillar ADEM6.

Command	Description
CAT ADEM6 Disable AT regen switch	Proprietary command

3.4.9 J1939 measurements

You can configure the view lines on the display to show these values.

For Modbus scaling, see the **Modbus tables**.

- PGN: Parameter group number
- P: J1939 priority
- S: Object's start byte in CAN telegram
- L: Object's length (bytes)
- Unit: Unit in display (bar/°C can be changed to psi/°F)

Measurements

Object	PGN	P	S	L	SPN	Unit	J1939-71 scaling	Offset
EIC Coolant Temp 2 ¹	64870	6	1	1	4076	°C/°F	1 °C/bit	-40 °C
EIC Coolant Temp 3 ¹	64870	6	8	1	6209	°C/°F	1 °C/bit	-40 °C
EIC Coolant Pump Outlet Temp ¹	64870	6	2	1	4193	°C/°F	1 °C/bit	-40 °C
EIC Filtered Fuel Delivery Pressure ¹	64735	6	2	1	5579	kPa	4 kPa/bit	0

Object	PGN	P	S	L	SPN	Unit	J1939-71 scaling	Offset
EIC Auxiliary Coolant Temp ¹	65172	6	2	1	1212	kPa	4 kPa/bit	0
EIC Turbo 1 Intake Temp ¹	65176	6	1	2	1180	°C/°F	0.03125 °C/bit	-273 °C
EIC Turbo 2 Intake Temp ¹	65176	6	3	2	1181	°C/°F	0.03125 °C/bit	-273 °C
EIC Exhaust Gas P1 Temp ²	65187	7	1	2	1137	°C/°F	0.03125 °C/bit	-273 °C
EIC Exhaust Gas P2 Temp ²	65187	7	3	2	1138	°C/°F	0.03125 °C/bit	-273 °C
EIC Exhaust Gas P3 Temp ²	65187	7	5	2	1139	°C/°F	0.03125 °C/bit	-273 °C
EIC Exhaust Gas P4 Temp ²	65187	7	7	2	1140	°C/°F	0.03125 °C/bit	-273 °C
EIC Exhaust Gas P5 Temp ²	65186	7	1	2	1141	°C/°F	0.03125 °C/bit	-273 °C
EIC Exhaust Gas P6 Temp ²	65186	7	3	2	1142	°C/°F	0.03125 °C/bit	-273 °C
EIC Exhaust Gas P7 Temp ²	65186	7	5	2	1143	°C/°F	0.03125 °C/bit	-273 °C
EIC Exhaust Gas P8 Temp ²	65186	7	7	2	1144	°C/°F	0.03125 °C/bit	-273 °C
EIC Exhaust Gas P9 Temp ²	65185	7	1	2	1145	°C/°F	0.03125 °C/bit	-273 °C
EIC Exhaust Gas P10 Temp ²	65185	7	3	2	1146	°C/°F	0.03125 °C/bit	-273 °C
EIC Exhaust Gas P11 Temp ²	65185	7	5	2	1147	°C/°F	0.03125 °C/bit	-273 °C
EIC Exhaust Gas P12 Temp ²	65185	7	7	2	1148	°C/°F	0.03125 °C/bit	-273 °C
EIC Exhaust Gas P13 Temp ²	65184	7	1	2	1149	°C/°F	0.03125 °C/bit	-273 °C
EIC Exhaust Gas P14 Temp ²	65184	7	3	2	1150	°C/°F	0.03125 °C/bit	-273 °C
EIC Exhaust Gas P15 Temp ²	65184	7	5	2	1151	°C/°F	0.03125 °C/bit	-273 °C
EIC Exhaust Gas P16 Temp ²	65184	7	7	2	1152	°C/°F	0.03125 °C/bit	-273 °C

NOTE 1: Fixed to source address 0.

NOTE 2: Fixed to source address 241.

3.4.10 Modbus analogue values

Measurement table (read only) function code 04h

Address	Content	Unit	Scaling
947	EIC Exhaust Gas P1 Temp	°C/°F	1/10
948	EIC Exhaust Gas P2 Temp	°C/°F	1/10
949	EIC Exhaust Gas P3 Temp	°C/°F	1/10
950	EIC Exhaust Gas P4 Temp	°C/°F	1/10
951	EIC Exhaust Gas P5 Temp	°C/°F	1/10
952	EIC Exhaust Gas P6 Temp	°C/°F	1/10
953	EIC Exhaust Gas P7 Temp	°C/°F	1/10
954	EIC Exhaust Gas P8 Temp	°C/°F	1/10
955	EIC Exhaust Gas P9 Temp	°C/°F	1/10
956	EIC Exhaust Gas P10 Temp	°C/°F	1/10
957	EIC Exhaust Gas P11 Temp	°C/°F	1/10
958	EIC Exhaust Gas P12 Temp	°C/°F	1/10
959	EIC Exhaust Gas P13 Temp	°C/°F	1/10
960	EIC Exhaust Gas P14 Temp	°C/°F	1/10

Address	Content	Unit	Scaling
961	EIC Exhaust Gas P15 Temp	°C/°F	1/10
962	EIC Exhaust Gas P16 Temp	°C/°F	1/10
967	EIC Filtered Fuel Delivery Press	bar/psi	1/100
968	EIC Coolant Temp 2	°C/°F	1/1
969	EIC Coolant Temp 3	°C/°F	1/1
970	EIC Coolant Pump Outlet Temp	°C/°F	1/1
971	EIC Auxiliary Coolant Temp	°C/°F	1/1
972	EIC Turbo 1 Intake Temp	°C/°F	1/10
973	EIC Turbo 2 Intake Temp	°C/°F	1/10

3.4.11 Modbus alarms

Alarm, status and measurement table (read only) function code 04h.

Addr.	Content	Bit	Type
1020	EIC alarms, DEIF controller	0	7570 EIC communication error
		1	7580 EIC warning
		2	7590 EIC shutdown
		3	7600 EIC overspeed
		4	7610 EIC coolant water temperature 1
		5	7620 EIC coolant water temperature 2
		6	7630 EIC oil pressure 1
		7	7640 EIC oil pressure 2
		8	7650 EIC oil temp. 1
		9	7660 EIC oil temp. 2
		10	7670 EIC coolant level 1
		11	7680 EIC coolant level 2
1024	EIC alarms, engine controller (DM1)	1	EIC low oil pressure, warning
		2	EIC low oil pressure, shutdown
		3	EIC boost pressure, warning
		4	EIC high coolant temperature, warning
		5	EIC low coolant level, shutdown
		6	EIC high inlet air temperature, warning
		7	EIC fuel temperature, warning
		8	EIC ECU yellow lamp, warning
		9	EIC ECU red lamp, shutdown
		10	EIC overspeed, warning
		11	EIC overspeed, shutdown
		12	EIC protection
		13	EIC malfunction

3.5 Cummins

3.5.1 Cummins CM 500

ECU(s)	CM 500		
Engine(s)	QSL, QSB5, QSX7, QSM11, QSK 19/50		
Engine interface protocol (parameter 7561)	Cummins CM500		
EIC control			
Start	-		
Stop	-		
Speed control	●		
Default speed control source address	220		
J1939 message			
Idle mode	●		
50/60 Hz frequency selection	●		
Shutdown override	●		
Proprietary message(s)	Governor gain, droop		
Diagnostic messages			
DM1 Yellow lamp	●		
DM1 Red lamp	●		
DM1 Protect	●		
DM1 Malfunction	●		
DM2	-		
Emissions			
Tier 4/Stage V	-		
Force regeneration	-		
Inhibit regeneration	-		
Analogue readings*			
Engine speed	●	Inlet temperature	●
Percent load	●	Exhaust temperature	-
Oil pressure	●	Fuel pressure	-
Oil temperature	●	Fuel temperature	●
Coolant pressure	●	Water in fuel	-
Coolant temperature	●	Fuel consumption/rate (L/h)	●
Turbo pressure	●	Fuel used (L)	-
Atmospheric pressure	●	Battery voltage	-
Engine hours	-	Battery potential (voltage)	●

NOTE *External equipment can read all of these from the AGC Modbus server. Other EIC analogue readings may also be available.

3.5.2 Cummins CM 558

ECU(s)	CM 558		
Engine(s)	QSL, QSB5, QSX7, QSM11, QSK 19/50		
Engine interface protocol (parameter 7561)	Cummins CM558		
EIC control			
Start	-		
Stop	-		
Speed control	●		
Default speed control source address	220		
J1939 message			
Idle mode	●		
50/60 Hz frequency selection	●		
Shutdown override	●		
Proprietary message(s)	Governor gain, droop		
Diagnostic messages			
DM1 Yellow lamp	●		
DM1 Red lamp	●		
DM1 Protect	●		
DM1 Malfunction	●		
DM2	-		
Emissions			
Tier 4/Stage V	-		
Force regeneration	-		
Inhibit regeneration	-		
Analogue readings*			
Engine speed	●	Inlet temperature	-
Percent load	●	Exhaust temperature	-
Oil pressure	●	Fuel pressure	●
Oil temperature	●	Fuel temperature	-
Coolant pressure	-	Water in fuel	●
Coolant temperature	●	Fuel consumption/rate (L/h)	-
Turbo pressure	-	Fuel used (L)	-
Atmospheric pressure	●	Battery voltage	-
Engine hours	-	Battery potential (voltage)	●

NOTE *External equipment can read all of these from the AGC Modbus server. Other EIC analogue readings may also be available.

3.5.3 Cummins CM 570

ECU(s)	CM 570		
Engine(s)	QSL, QSB5, QSX7, QSM11, QSK 19/50		
Engine interface protocol (parameter 7561)	Cummins CM570		
EIC control			
Start	-		
Stop	-		
Speed control	●		
Default speed control source address	220		
J1939 message			
Idle mode	●		
50/60 Hz frequency selection	●		
Shutdown override	●		
Proprietary message(s)	Governor gain, droop		
Diagnostic messages			
DM1 Yellow lamp	●		
DM1 Red lamp	●		
DM1 Protect	●		
DM1 Malfunction	●		
DM2	-		
Emissions			
Tier 4/Stage V	-		
Force regeneration	-		
Inhibit regeneration	-		
Analogue readings*			
Engine speed	●	Inlet temperature	-
Percent load	●	Exhaust temperature	-
Oil pressure	●	Fuel pressure	-
Oil temperature	●	Fuel temperature	-
Coolant pressure	-	Water in fuel	-
Coolant temperature	●	Fuel consumption/rate (L/h)	●
Turbo pressure	●	Fuel used (L)	-
Atmospheric pressure	●	Battery voltage	-
Engine hours	-	Battery potential (voltage)	-

NOTE *External equipment can read all of these from the AGC Modbus server. Other EIC analogue readings may also be available.

3.5.4 Cummins CM 850

ECU(s)	CM 850		
Engine(s)	QSL, QSB5, QSX7, QSM11, QSK 19/50		
Engine interface protocol (parameter 7561)	Cummins CM850		
EIC control			
Start	-		
Stop	-		
Speed control	●		
Default speed control source address	220		
J1939 message			
Idle mode	●		
50/60 Hz frequency selection	●		
Shutdown override	●		
Proprietary message(s)	Governor gain, droop		
Diagnostic messages			
DM1 Yellow lamp	●		
DM1 Red lamp	●		
DM1 Protect	●		
DM1 Malfunction	●		
DM2	-		
Emissions			
Tier 4/Stage V	-		
Force regeneration	-		
Inhibit regeneration	-		
Analogue readings*			
Engine speed	●	Inlet temperature	-
Percent load	●	Exhaust temperature	●
Oil pressure	●	Fuel pressure	●
Oil temperature	●	Fuel temperature	●
Coolant pressure	●	Water in fuel	●
Coolant temperature	●	Fuel consumption/rate (L/h)	●
Turbo pressure	●	Fuel used (L)	●
Atmospheric pressure	●	Battery voltage	-
Engine hours	●	Battery potential (voltage)	●

NOTE *External equipment can read all of these from the AGC Modbus server. Other EIC analogue readings may also be available.

3.5.5 Cummins CM 2150

ECU(s)	CM 2150		
Engine(s)	QSL, QSB5, QSX7, QSM11, QSK 19/50		
Engine interface protocol (parameter 7561)	Cummins CM2150		
EIC control			
Start	-		
Stop	-		
Speed control	●		
Default speed control source address	220		
J1939 message			
Idle mode	●		
50/60 Hz frequency selection	●		
Shutdown override	●		
Proprietary message(s)	Governor gain, droop		
Diagnostic messages			
DM1 Yellow lamp	●		
DM1 Red lamp	●		
DM1 Protect	●		
DM1 Malfunction	●		
DM2	-		
Emissions			
Tier 4/Stage V	●		
Force regeneration	●		
Inhibit regeneration	●		
Analogue readings*			
Engine speed	●	Inlet temperature	-
Percent load	●	Exhaust temperature	●
Oil pressure	●	Fuel pressure	●
Oil temperature	●	Fuel temperature	●
Coolant pressure	●	Water in fuel	●
Coolant temperature	●	Fuel consumption/rate (L/h)	●
Turbo pressure	●	Fuel used (L)	●
Atmospheric pressure	●	Battery voltage	-
Engine hours	●	Battery potential (voltage)	●

NOTE *External equipment can read all of these from the AGC Modbus server. Other EIC analogue readings may also be available.

3.5.6 Cummins CM 2250

ECU(s)	CM 2250		
Engine(s)	QSL, QSB5, QSX7, QSM11, QSK 19/50		
Engine interface protocol (parameter 7561)	Cummins CM2250		
EIC control			
Start	-		
Stop	-		
Speed control	●		
Default speed control source address	220		
J1939 message			
Idle mode	●		
50/60 Hz frequency selection	●		
Shutdown override	●		
Proprietary message(s)	Governor gain, droop		
Diagnostic messages			
DM1 Yellow lamp	●		
DM1 Red lamp	●		
DM1 Protect	●		
DM1 Malfunction	●		
DM2	-		
Emissions			
Tier 4/Stage V	●		
Force regeneration	●		
Inhibit regeneration	●		
Analogue readings*			
Engine speed	●	Inlet temperature	-
Percent load	●	Exhaust temperature	-
Oil pressure	●	Fuel pressure	-
Oil temperature	●	Fuel temperature	-
Coolant pressure	-	Water in fuel	-
Coolant temperature	●	Fuel consumption/rate (L/h)	●
Turbo pressure	●	Fuel used (L)	-
Atmospheric pressure	●	Battery voltage	-
Engine hours	-	Battery potential (voltage)	-

NOTE *External equipment can read all of these from the AGC Modbus server. Other EIC analogue readings may also be available.

3.5.7 Cummins Generic

ECU(s)	CM 500, CM 558, CM 570, CM 850, CM 2150 and CM 2250		
Engine(s)	QSL, QSB5, QSB7, QSM11, QSK 19/50		
Engine interface protocol (parameter 7561)	Cummins Generic		
EIC control			
Start	-		
Stop	-		
Speed control	●		
Default speed control source address	220		
J1939 message			
Idle mode	●		
50/60 Hz frequency selection	●		
Shutdown override	●		
Proprietary message(s)	Governor gain, droop		
Diagnostic messages			
DM1 Yellow lamp	●		
DM1 Red lamp	●		
DM1 Protect	●		
DM1 Malfunction	●		
DM2	-		
Emissions			
Tier 4/Stage V	●		
Force regeneration	●		
Inhibit regeneration	●		
Analogue readings*			
Engine speed	●	Inlet temperature	●
Percent load	●	Exhaust temperature	●
Oil pressure	●	Fuel pressure	●
Oil temperature	●	Fuel temperature	●
Coolant pressure	●	Water in fuel	●
Coolant temperature	●	Fuel consumption/rate (L/h)	●
Turbo pressure	●	Fuel used (L)	●
Atmospheric pressure	●	Battery voltage	-
Engine hours	●	Battery potential (voltage)	●

NOTE *External equipment can read all of these from the AGC Modbus server. Other EIC analogue readings may also be available.

3.5.8 Cummins CM 2350

ECU(s)	CM 2350		
Engine(s)			
Engine interface protocol (parameter 7561)	Cummins CM2350		
EIC control			
Start	●		
Stop	-		
Speed control	●		
Default speed control source address	220		
J1939 message			
Idle mode	●		
50/60 Hz frequency selection	●		
Shutdown override	●		
Proprietary message(s)	Governor gain, droop		
Diagnostic messages			
DM1 Yellow lamp	●		
DM1 Red lamp	●		
DM1 Protect	●		
DM1 Malfunction	●		
DM2	-		
Emissions			
Tier 4/Stage V	●		
Force regeneration	●		
Inhibit regeneration	●		
Analogue readings*			
Engine speed	●	Inlet temperature	-
Percent load	●	Exhaust temperature	-
Oil pressure	●	Fuel pressure	-
Oil temperature	●	Fuel temperature	-
Coolant pressure	-	Water in fuel	-
Coolant temperature	●	Fuel consumption/rate (L/h)	●
Turbo pressure	●	Fuel used (L)	-
Atmospheric pressure	●	Battery voltage	-
Engine hours	-	Battery potential (voltage)	-

NOTE *External equipment can read all of these from the AGC Modbus server. Other EIC analogue readings may also be available.

3.5.9 Cummins CM 2850

ECU(s)	CM 2850		
Engine(s)			
Engine interface protocol (parameter 7561)	Cummins CM2850		
EIC control			
Start	●		
Stop	●		
Speed control	●		
Default speed control source address	234		
J1939 message	CM1, ECC, EBC1 and EES		
Idle mode	●		
50/60 Hz frequency selection	●		
Shutdown override	●		
Proprietary message(s)	See Cummins documentation		
Diagnostic messages			
DM1 Yellow lamp	●		
DM1 Red lamp	●		
DM1 Protect	●		
DM1 Malfunction	●		
DM2	●		
Emissions			
Tier 4/Stage V	●		
Force regeneration	●		
Inhibit regeneration	●		
Analogue readings*			
Engine speed	●	Inlet temperature	-
Percent load	-	Exhaust temperature	●
Oil pressure	●	Fuel pressure	●
Oil temperature	●	Fuel temperature	●
Coolant pressure	●	Water in fuel	●
Coolant temperature	●	Fuel consumption/rate (L/h)	●
Turbo pressure	●	Fuel used (L)	●
Atmospheric pressure	●	Battery voltage	-
Engine hours	●	Battery potential (voltage)	●

NOTE *External equipment can read all of these from the AGC Modbus server. Other EIC analogue readings may also be available.

3.5.10 Cummins CM 2880

ECU(s)	CM 2880		
Engine(s)			
Engine interface protocol (parameter 7561)	Cummins CM2880		
EIC control			
Start	-		
Stop	-		
Speed control	●		
Default speed control source address	220		
J1939 message			
Idle mode	●		
50/60 Hz frequency selection	●		
Shutdown override	●		
Proprietary message(s)	Governor gain, droop		
Diagnostic messages			
DM1 Yellow lamp	●		
DM1 Red lamp	●		
DM1 Protect	●		
DM1 Malfunction	●		
DM2	-		
Emissions			
Tier 4/Stage V	●		
Force regeneration	●		
Inhibit regeneration	●		
Analogue readings*			
Engine speed	●	Inlet temperature	-
Percent load	●	Exhaust temperature	-
Oil pressure	●	Fuel pressure	-
Oil temperature	●	Fuel temperature	-
Coolant pressure	-	Water in fuel	-
Coolant temperature	●	Fuel consumption/rate (L/h)	●
Turbo pressure	●	Fuel used (L)	-
Atmospheric pressure	●	Battery voltage	-
Engine hours	-	Battery potential (voltage)	-

NOTE *External equipment can read all of these from the AGC Modbus server. Other EIC analogue readings may also be available.

3.5.11 Cummins KTA19

ECU(s)	KTA19		
Engine(s)			
Engine interface protocol (parameter 7561)	Cummins KTA19		
EIC control			
Start	●		
Stop	●		
Speed control	●		
Default speed control source address	39		
J1939 message	GC2, ACS, GC1 and EES		
Idle mode	●		
50/60 Hz frequency selection	●		
Shutdown override			
Proprietary message(s)			
Diagnostic messages			
DM1 Yellow lamp	●		
DM1 Red lamp	●		
DM1 Protect	●		
DM1 Malfunction	●		
DM2	●		
Emissions			
Tier 4/Stage V			
Force regeneration			
Inhibit regeneration			
Analogue readings*			
Engine speed	●	Inlet temperature	-
Percent load	-	Exhaust temperature	●
Oil pressure	●	Fuel pressure	-
Oil temperature	●	Fuel temperature	●
Coolant pressure	●	Water in fuel	-
Coolant temperature	●	Fuel consumption/rate (L/h)	-
Turbo pressure	-	Fuel used (L)	-
Atmospheric pressure	●	Battery voltage	-
Engine hours	●	Battery potential (voltage)	●

NOTE *External equipment can read all of these from the AGC Modbus server. Other EIC analogue readings may also be available.

3.5.12 Warnings and shutdowns

Warning and shutdown list	J1939 codes		
	SPN	FMI warning	FMI shutdown
Low oil pressure	100	18	1
Coolant temperature	110	16	0
Oil temperature	175	16	0
Intake manifold temp	105	16	0
Fuel temperature	174	16	0
Coolant level low	111	18	1
Overspeed	190	-	16
Crankcase pressure high	101	-	0
Coolant pressure low	109	-	1

NOTE If FMI is "-" the alarm is not supported.

3.5.13 Write commands

Use parameter 7563 (EIC Controls) to enable write commands.

Cummins write commands

Command	Description
Speed control	In general, this is the same as the J1939 command . However, the CAN bus ID for speed control (engine with PCC controller): 0xOFF69DC. <ul style="list-style-type: none"> If the AGC is replacing a Cummins PCC1301, enable the M-Logic function <i>EIC Select Cummins PCC1301</i>. This automatically configures the source address of the AGC as 0xDC (220).
Idle speed	See the J1939 command .
Frequency selection (50 or 60 Hz)	In general, see the J1939 command . In addition, the AGC meets the proprietary requirements for this command.
Governor gain	You can set the ECU governor gain in parameter 2773 (Cummins gain). The AGC sends this value to the ECU.
Droop	Use M-Logic to enable sending a droop set point: <i>Output, EIC commands, EIC Droop</i> . When <i>EIC Droop</i> is activated, the AGC sends the droop setting in parameter 2771 as the set point for the ECU droop.
Shutdown override	See the J1939 command .

3.5.14 Cummins After Treatment

If Cummins After Treatment equipment is installed in the exhaust line and the system is connected to the ECU, then the AGC can receive the treatment system data. In addition, some regeneration can be controlled.

The table shows lamps and status indicators from the after treatment. This information is available in M-Logic (under *Events, EIC event*). For example, you can configure an AOP-2 display to use the EIC events.

Status indicator state	Source	M-Logic event
OFF	Particulate filter lamp	DPF Lamp OFF
OFF	High exhaust system temp.	High Exh Syst Temp OFF (lamp)

Status indicator state	Source	M-Logic event
ON solid	Particulate filter lamp	DPF Lamp ON (solid)
ON solid	High exhaust system temp.	High Exh Syst Temp ON (lamp)
ON fast blink	Particulate filter lamp	DPF Lamp ON (blink)
Inhibited	Regeneration disabled	DPF Regen inhibited (lamp)
Not inhibited	Regeneration disabled	DPF Regen not inhibited (lamp)
Not Active	Diesel particulate filter regeneration status	DPF Active Regeneration not activated (status)
Active	Diesel particulate filter regeneration status	DPF Active Regeneration activated (status)
Regeneration needed	Diesel particulate filter regeneration status	DPF Active Regeneration needed (status)
Regeneration not needed	Diesel particulate filter status	DPF Regen not needed (status)
Regeneration lowest level	Diesel particulate filter status	DPF Regen needed - lowest level (status)
Regeneration moderate level	Diesel particulate filter status	DPF Regen needed - moderate level (status)
---Regeneration highest level	Diesel particulate filter status	DPF Regen needed - highest level (status)

3.5.15 Modbus alarms

Alarm, status and measurement table (read only) function code 04h.

Addr.	Content	Bit	Type
1020	EIC alarms, DEIF controller	0	7570 EIC communication error
		1	7580 EIC warning
		2	7590 EIC shutdown
		3	7600 EIC overspeed
		4	7610 EIC coolant water temperature 1
		5	7620 EIC coolant water temperature 2
		6	7630 EIC oil pressure 1
		7	7640 EIC oil pressure 2
		8	7650 EIC oil temp. 1
		9	7660 EIC oil temp. 2
		10	7670 EIC coolant level 1
		11	7680 EIC coolant level 2
1023	EIC alarms, engine controller (DM1)	0	EIC yellow
		1	Red
		2	EIC protection
		3	EIC malfunction

Addr.	Content	Bit	Type
1024	EIC alarms, engine controller (DM1)	0	EIC DEC communication error
		1	EIC low oil pressure, warning
		2	EIC low oil pressure, shutdown
		3	EIC high coolant temp, warning
		4	EIC high coolant temperature, shutdown
		5	EIC low coolant level, warning
		6	EIC low coolant level, shutdown
		7	EIC intake manifold temp, warning
		8	EIC intake manifold, shutdown
		9	EIC fuel temp., warning
		10	EIC fuel temp, shutdown
		11	EIC coolant pressure, shutdown
		12	EIC oil temp., warning
		13	EIC oil temp., warning
		14	EIC overspeed shutdown
		15	EIC crankcase press., shutdown

3.6 Detroit Diesel

3.6.1 Detroit Diesel DDEC III

ECU(s)	DDEC III		
Engine(s)	Series 50, 60 and 2000		
Engine interface protocol (parameter 7561)	DDEC III		
EIC control			
Start	-		
Stop	-		
Speed control	●		
Default speed control source address	3		
J1939 message	TSC1		
Idle mode	●		
50/60 Hz frequency selection	●		
Shutdown override	-		
Proprietary message(s)	-		
Diagnostic messages			
DM1 Yellow lamp	●		
DM1 Red lamp	●		
DM1 Protect	●		
DM1 Malfunction	●		
DM2	●		
Emissions			
Tier 4/Stage V	-		
Force regeneration	-		
Inhibit regeneration	-		
Analogue readings*			
Engine speed	●	Inlet temperature	●
Percent load	●	Exhaust temperature	●
Oil pressure	●	Fuel pressure	●
Oil temperature	●	Fuel temperature	●
Coolant pressure	●	Water in fuel	-
Coolant temperature	●	Fuel consumption/rate (L/h)	●
Turbo pressure	●	Fuel used (L)	●
Atmospheric pressure	●	Battery voltage	-
Engine hours	●	Battery potential (voltage)	●

NOTE *External equipment can read all of these from the AGC Modbus server. Other EIC analogue readings may also be available.

3.6.2 Detroit Diesel DDEC IV

ECU(s)	DDEC IV		
Engine(s)	Series 50, 60 and 2000		
Engine interface protocol (parameter 7561)	DDEC IV		
EIC control			
Start	-		
Stop	-		
Speed control	●		
Default speed control source address	3		
J1939 message	TSC1		
Idle mode	●		
50/60 Hz frequency selection	●		
Shutdown override	-		
Proprietary message(s)	-		
Diagnostic messages			
DM1 Yellow lamp	●		
DM1 Red lamp	●		
DM1 Protect	●		
DM1 Malfunction	●		
DM2	●		
Emissions			
Tier 4/Stage V	-		
Force regeneration	-		
Inhibit regeneration	-		
Analogue readings*			
Engine speed	●	Inlet temperature	●
Percent load	●	Exhaust temperature	●
Oil pressure	●	Fuel pressure	●
Oil temperature	●	Fuel temperature	●
Coolant pressure	●	Water in fuel	-
Coolant temperature	●	Fuel consumption/rate (L/h)	●
Turbo pressure	●	Fuel used (L)	●
Atmospheric pressure	●	Battery voltage	-
Engine hours	●	Battery potential (voltage)	●

NOTE *External equipment can read all of these from the AGC Modbus server. Other EIC analogue readings may also be available.

3.6.3 Write commands

Use parameter 7563 (EIC Controls) to enable write commands.

Detroit Diesel DDEC write commands

Command	Description
Speed control	See the J1939 command .
Idle speed	See the J1939 command .

3.6.4 Modbus alarms

Alarm, status and measurement table (read only) function code 04h.

Addr.	Content	Bit	Type
1020	EIC alarms, DEIF controller	0	7570 EIC communication error
		1	7580 EIC warning
		2	7590 EIC shutdown
		3	7600 EIC overspeed
		4	7610 EIC coolant water temperature 1
		5	7620 EIC coolant water temperature 2
		6	7630 EIC oil pressure 1
		7	7640 EIC oil pressure 2
		8	7650 EIC oil temp. 1
		9	7660 EIC oil temp. 2
		10	7670 EIC coolant level 1
		11	7680 EIC coolant level 2
1024	EIC alarms, engine controller (DM1)	0	EIC communication error, warning
		1	EIC warning
		2	EIC shutdown
		3	EIC protection
		4	EIC malfunction

3.7 Deutz

3.7.1 Deutz EMR2

ECU(s)	EMR 2		
Engine(s)			
Engine interface protocol (parameter 7561)	Deutz EMR 2		
EIC control			
Start	-		
Stop	●		
Speed control	●		
Default speed control source address	3		
J1939 message	TSC1		
Idle mode	●		
50/60 Hz frequency selection	●		
Shutdown override	-		
Proprietary message(s)	Engine Stop Request		
Diagnostic messages			
DM1 Yellow lamp	●		
DM1 Red lamp	●		
DM1 Protect	●		
DM1 Malfunction	●		
DM2	●		
Emissions			
Tier 4/Stage V	-		
Force regeneration	-		
Inhibit regeneration	-		
Analogue readings*			
Engine speed	●	Inlet temperature	-
Percent load	●	Exhaust temperature	-
Oil pressure	●	Fuel pressure	-
Oil temperature	-	Fuel temperature	●
Coolant pressure	-	Water in fuel	-
Coolant temperature	●	Fuel consumption/rate (L/h)	●
Turbo pressure	●	Fuel used (L)	-
Atmospheric pressure	●	Battery voltage	●
Engine hours	●	Battery potential (voltage)	-

NOTE *External equipment can read all of these from the AGC Modbus server. Other EIC analogue readings may also be available.

3.7.2 Deutz EMR3

ECU(s)	EMR 3		
Engine(s)			
Engine interface protocol (parameter 7561)	Deutz EMR 3		
EIC control			
Start	-		
Stop	●		
Speed control	●		
Default speed control source address	3		
J1939 message	TSC1		
Idle mode	●		
50/60 Hz frequency selection	●		
Shutdown override	-		
Proprietary message(s)	Engine Stop Request		
Diagnostic messages			
DM1 Yellow lamp	●		
DM1 Red lamp	●		
DM1 Protect	●		
DM1 Malfunction	●		
DM2	●		
Emissions			
Tier 4/Stage V	-		
Force regeneration	-		
Inhibit regeneration	-		
Analogue readings*			
Engine speed	●	Inlet temperature	-
Percent load	●	Exhaust temperature	-
Oil pressure	●	Fuel pressure	-
Oil temperature	-	Fuel temperature	●
Coolant pressure	-	Water in fuel	-
Coolant temperature	●	Fuel consumption/rate (L/h)	●
Turbo pressure	●	Fuel used (L)	-
Atmospheric pressure	●	Battery voltage	●
Engine hours	●	Battery potential (voltage)	-

NOTE *External equipment can read all of these from the AGC Modbus server. Other EIC analogue readings may also be available.

3.7.3 Deutz EMR4

ECU(s)	EMR4		
Engine(s)			
Engine interface protocol (parameter 7561)	Deutz EMR 4		
EIC control			
Start	●		
Stop	●		
Speed control	●		
Default speed control source address	3		
J1939 message	TSC1, CM1, GC1		
Idle mode	●		
50/60 Hz frequency selection	●		
Shutdown override	-		
Diagnostic messages			
DM1 Yellow lamp	●		
DM1 Red lamp	●		
DM1 Protect	●		
DM1 Malfunction	●		
DM2	●		
Emissions			
Tier 4/Stage V	●		
Force regeneration	●		
Inhibit regeneration	●		
Analogue readings*			
Engine speed	●	Inlet temperature	●
Percent load	●	Exhaust temperature	●
Oil pressure	●	Fuel pressure	●
Oil temperature	●	Fuel temperature	●
Coolant pressure	●	Water in fuel	●
Coolant temperature	●	Fuel consumption/rate (L/h)	●
Turbo pressure	●	Fuel used (L)	●
Atmospheric pressure	●	Battery voltage	●
Engine hours	●	Battery potential (voltage)	●

NOTE *External equipment can read all of these from the AGC Modbus server. Other EIC analogue readings may also be available.

3.7.4 Deutz EMR5

ECU(s)	EMR 5		
Engine(s)	-		
Engine interface protocol (parameter 7561)	Deutz EMR 5		
EIC control			
Start	-		
Stop	●		
Speed control	●		
Default speed control source address	39		
J1939 message	TSC1, CM1		
Idle mode	●		
50/60 Hz frequency selection	●		
Shutdown override	-		
Proprietary message(s)	VCM2ECM, BC2EDC2		
Diagnostic messages			
DM1 Yellow lamp	●		
DM1 Red lamp	●		
DM1 Protect	●		
DM1 Malfunction	●		
DM2	●		
Emissions			
Tier 4/Stage V	-		
Force regeneration	-		
Inhibit regeneration	-		
Analogue readings*			
Engine speed	●	Inlet temperature	-
Percent load	●	Exhaust temperature	-
Oil pressure	●	Fuel pressure	-
Oil temperature	●	Fuel temperature	●
Coolant pressure	-	Water in fuel	●
Coolant temperature	●	Fuel consumption/rate (L/h)	●
Turbo pressure	●	Fuel used (L)	●
Atmospheric pressure	●	Battery voltage	●
Engine hours	●	Battery potential (voltage)	●

NOTE *External equipment can read all of these from the AGC Modbus server. Other EIC analogue readings may also be available.

3.7.5 Deutz EMR4/EMR5 Stage V

ECU(s)	EMR4/EMR5 Stage V		
Engine(s)	-		
Engine interface protocol (parameter 7561)	Deutz EMR 5 Stage V		
EIC control			
Start	-		
Stop	●		
Speed control	●		
Default speed control source address	3		
J1939 message	TSC1, CM1		
Idle mode	●		
50/60 Hz frequency selection	●		
Shutdown override	-		
Proprietary message(s)	Engine Stop Request, Neutral signal for standstill		
Diagnostic messages			
DM1 Yellow lamp	●		
DM1 Red lamp	●		
DM1 Protect	●		
DM1 Malfunction	●		
DM2	●		
Emissions			
Tier 4/Stage V	●		
Force regeneration	●		
Inhibit regeneration	●		
Analogue readings*			
Engine speed	●	Inlet temperature	●
Percent load	●	Exhaust temperature	-
Oil pressure	●	Fuel pressure	●
Oil temperature	-	Fuel temperature	-
Coolant pressure	-	Water in fuel	-
Coolant temperature	●	Fuel consumption/rate (L/h)	●
Turbo pressure	●	Fuel used (L)	●
Atmospheric pressure	●	Battery voltage	●
Engine hours	●	Battery potential (voltage)	●

NOTE *External equipment can read all of these from the AGC Modbus server. Other EIC analogue readings may also be available.

3.7.6 Warnings and shutdowns

Warning and shutdown list	J1939 codes		
	SPN	FMI warning	FMI shutdown
Low oil pressure	100	-	1
Coolant temperature	110	-	0
Overspeed	190	-	0

NOTE If FMI is "-" the alarm is not supported.

3.7.7 Write commands

Use parameter 7563 (EIC Controls) to enable write commands.

Deutz write commands

Command	Description
Speed control	In general, this is the same as the J1939 command .
Idle speed	See the J1939 command .
Stop request	When the AGC wants to stop the engine, it sends this proprietary telegram.

3.7.8 M-Logic (Deutz EMR5)

Events

The following additional events are available in M-Logic under *Events*, *EIC event* for Deutz EMR 5.

Event	Description
Deutz EMR 5 Standstill request from SCR system	Proprietary event.
Deutz EMR 5 Standstill request due to maintenance	Proprietary event.
Deutz EMR 5 Standstill request due to time in headmode 2	Proprietary event.
Deutz EMR 5 Standstill request due to high filter soot load	Proprietary event.
Deutz EMR 5 Standstill no request	Proprietary event.

3.7.9 Modbus alarms

Alarm, status and measurement table (read only) function code 04h.

Addr.	Content	Bit	Type
1020	EIC alarms, DEIF controller	0	7570 EIC communication error
		1	7580 EIC warning
		2	7590 EIC shutdown
		3	7600 EIC overspeed
		4	7610 EIC coolant water temperature 1
		5	7620 EIC coolant water temperature 2
		6	7630 EIC oil pressure 1
		7	7640 EIC oil pressure 2
		8	650 EIC oil temp. 1
		9	7660 EIC oil temp. 2
		10	7670 EIC coolant level 1
		11	7680 EIC coolant level 2
1024	EIC alarms, engine controller (DM1)	0	EIC high coolant temperature, shutdown
		1	EIC low oil pressure, shutdown
		2	EIC overspeed, shutdown
		3	EIC EMR shutdown (LS: lamp status)
		4	EIC EMR warning (LS: lamp status)
		5	EIC communication error
		6	EIC protection
		7	EIC malfunction

3.8 Doosan

3.8.1 Doosan EDC17

ECU(s)	EDC17		
Engine(s)			
Engine interface protocol (parameter 7561)	Doosan G2 EDC17		
EIC control			
Start	●		
Stop	●		
Speed control	●		
Default speed control source address	3		
J1939 message	TSC1, CM1, GC1		
Idle mode	●		
50/60 Hz frequency selection	●		
Shutdown override	-		
Diagnostic messages			
DM1 Yellow lamp	●		
DM1 Red lamp	●		
DM1 Protect	●		
DM1 Malfunction	●		
DM2	●		
Emissions			
Tier 4/Stage V	-		
Force regeneration	-		
Inhibit regeneration	-		
Analogue readings*			
Engine speed	●	Inlet temperature	●
Percent load	●	Exhaust temperature	●
Oil pressure	●	Fuel pressure	●
Oil temperature	●	Fuel temperature	●
Coolant pressure	●	Water in fuel	●
Coolant temperature	●	Fuel consumption/rate (L/h)	●
Turbo pressure	●	Fuel used (L)	●
Atmospheric pressure	●	Battery voltage	●
Engine hours	●	Battery potential (voltage)	●

NOTE *External equipment can read all of these from the AGC Modbus server. Other EIC analogue readings may also be available.

3.8.2 Doosan MD1

ECU(s)	MD1		
Engine(s)	-		
Engine interface protocol (parameter 7561)	Doosan MD1		
EIC control			
Start	-		
Stop	●		
Speed control	●		
Default speed control source address	39		
J1939 message	TSC1, CM1		
Idle mode	●		
50/60 Hz frequency selection	●		
Shutdown override	-		
Proprietary message(s)	VCM2ECM, BC2EDC2		
Diagnostic messages			
DM1 Yellow lamp	●		
DM1 Red lamp	●		
DM1 Protect	●		
DM1 Malfunction	●		
DM2	●		
Emissions			
Tier 4/Stage V	●		
Force regeneration	●		
Inhibit regeneration	●		
Analogue readings*			
Engine speed	●	Inlet temperature	-
Percent load	●	Exhaust temperature	-
Oil pressure	●	Fuel pressure	-
Oil temperature	●	Fuel temperature	●
Coolant pressure	-	Water in fuel	●
Coolant temperature	●	Fuel consumption/rate (L/h)	●
Turbo pressure	●	Fuel used (L)	●
Atmospheric pressure	●	Battery voltage	●
Engine hours	●	Battery potential (voltage)	●

NOTE *External equipment can read all of these from the AGC Modbus server. Other EIC analogue readings may also be available.

3.8.3 Doosan stage 5

ECU(s)	G2 EDC17		
Engine(s)	-		
Engine interface protocol (parameter 7561)	Doosan stage 5		
EIC control			
Start	●		
Stop	●		
Speed control	●		
Default speed control source address	FD		
J1939 message	TSC1, CM1		
Idle mode	●		
50/60 Hz frequency selection	●		
Shutdown override	-		
Proprietary message(s)			
Diagnostic messages			
DM1 Yellow lamp	●		
DM1 Red lamp	●		
DM1 Protect	●		
DM1 Malfunction	●		
DM2	●		
Emissions			
Tier 4/Stage V	●		
Force regeneration	●		
Inhibit regeneration	●		
Analogue readings*			
Engine speed	●	Inlet temperature	●
Percent load	●	Exhaust temperature	●
Oil pressure	●	Fuel pressure	●
Oil temperature	●	Fuel temperature	●
Coolant pressure	-	Water in fuel	●
Coolant temperature	●	Fuel consumption/rate (L/h)	●
Turbo pressure	●	Fuel used (L)	●
Atmospheric pressure	●	Battery voltage	-
Engine hours	●	Battery potential (voltage)	-

NOTE *External equipment can read all of these from the AGC Modbus server. Other EIC analogue readings may also be available.

3.8.4 M-Logic events

The following additional events are available in M-Logic under *Events*, *EIC event* for Doosan.

Event	Description
Doosan stage 5 ash lamp status < 100%	Proprietary event.
Doosan stage 5 ash lamp status 100%-105%	Proprietary event.
Doosan stage 5 ash lamp status 106%-110%	Proprietary event.
Doosan stage 5 ash lamp status 111%-120%	Proprietary event.
Doosan stage 5 ash lamp status > 121%	Proprietary event.

3.9 FPT Industrial

3.9.1 FPT Industrial EDC17

ECU(s)	EDC17		
Engine(s)			
Engine interface protocol (parameter 7561)	FPT EDC17CV41		
EIC control			
Start	●		
Stop	●		
Speed control	●		
Default speed control source address	3		
J1939 message	TSC1, CM1, GC1		
Idle mode	●		
50/60 Hz frequency selection	●		
Shutdown override	-		
Diagnostic messages			
DM1 Yellow lamp	●		
DM1 Red lamp	●		
DM1 Protect	●		
DM1 Malfunction	●		
DM2	●		
Emissions			
Tier 4/Stage V	●		
Force regeneration	●		
Inhibit regeneration	●		
Analogue readings*			
Engine speed	●	Inlet temperature	●
Percent load	●	Exhaust temperature	●
Oil pressure	●	Fuel pressure	●
Oil temperature	●	Fuel temperature	●
Coolant pressure	●	Water in fuel	●
Coolant temperature	●	Fuel consumption/rate (L/h)	●
Turbo pressure	●	Fuel used (L)	●
Atmospheric pressure	●	Battery voltage	●
Engine hours	●	Battery potential (voltage)	●

NOTE *External equipment can read all of these from the AGC Modbus server. Other EIC analogue readings may also be available.

3.9.2 FPT Industrial Bosch MD1

ECU(s)	Bosch MD1		
Engine(s)	-		
Engine interface protocol (parameter 7561)	FPT stage V		
EIC control			
Start	-		
Stop	●		
Speed control	●		
Default speed control source address	39		
J1939 message	TSC1, CM1		
Idle mode	●		
50/60 Hz frequency selection	●		
Shutdown override	-		
Proprietary message(s)	VCM2ECM, BC2EDC2		
Diagnostic messages			
DM1 Yellow lamp	●		
DM1 Red lamp	●		
DM1 Protect	●		
DM1 Malfunction	●		
DM2	●		
Emissions			
Tier 4/Stage V	●		
Force regeneration	●		
Inhibit regeneration	●		
Analogue readings*			
Engine speed	●	Inlet temperature	-
Percent load	●	Exhaust temperature	-
Oil pressure	●	Fuel pressure	-
Oil temperature	●	Fuel temperature	●
Coolant pressure	-	Water in fuel	●
Coolant temperature	●	Fuel consumption/rate (L/h)	●
Turbo pressure	●	Fuel used (L)	●
Atmospheric pressure	●	Battery voltage	●
Engine hours	●	Battery potential (voltage)	●

NOTE *External equipment can read all of these from the AGC Modbus server Other EIC analogue readings may also be available.

3.9.3 M-Logic events

This additional event is available in M-Logic under *Events, EIC event* for FPT.

Event	Description
FPT - High coolant pre-warning	Proprietary event.
FPT - High coolant warning	Proprietary event.
FPT - Engine overspeed	Proprietary event.
FPT - Engine high oil temperature	Proprietary event.
FPT - Engine oil low pressure	Proprietary event.
FPT DEF technical failure mild inducement	Proprietary event.
FPT DEF technical failure moderate inducement	Proprietary event.
FPT DEF technical failure severe inducement	Proprietary event.
FPT DEF quality driver warning	Proprietary event.
FPT DEF quality moderate inducement	Proprietary event.
FPT DEF quality severe inducement	Proprietary event.
FPT DEF level driver warning	Proprietary event.
FPT DEF level moderate inducement	Proprietary event.
FPT DEF level severe inducement	Proprietary event.
FPT - Turbo heat protection	Proprietary event. Activated when turbo heat protection is activated.

NOTE See also *Displaying proprietary text for SPN/FMI combinations.*

3.10 Hatz Diesel

3.10.1 Hatz Diesel 3H50TICD, 4H50TICD

ECU(s)			
Engine(s)		3H50TICD, 4H50TICD	
Engine interface protocol (parameter 7561)		Hatz	
EIC control			
Start		●	
Stop		●	
Speed control		●	
Default speed control source address		3	
J1939 message		TSC1, CM1	
Idle mode		●	
50/60 Hz frequency selection		●	
Shutdown override		-	
Diagnostic messages			
DM1 Yellow lamp		●	
DM1 Red lamp		●	
DM1 Protect		●	
DM1 Malfunction		●	
DM2			
Emissions			
Tier 4/Stage V		●	
Force regeneration		●	
Inhibit regeneration		●	
Analogue readings*			
Engine speed	●	Inlet temperature	-
Percent load	●	Exhaust temperature	●
Oil pressure	●	Fuel pressure	●
Oil temperature	●	Fuel temperature	●
Coolant pressure	-	Water in fuel	●
Coolant temperature	●	Fuel consumption/rate (L/h)	●
Turbo pressure	-	Fuel used (L)	-
Atmospheric pressure	●	Battery voltage	●
Engine hours	●	Battery potential (voltage)	●

NOTE *External equipment can read all of these from the AGC Modbus server. Other EIC analogue readings may also be available.

3.10.2 Hatz Diesel EDC17

ECU(s)	EDC17		
Engine(s)			
Engine interface protocol (parameter 7561)	Hatz EDC17		
EIC control			
Start	●		
Stop	●		
Speed control	●		
Default speed control source address	3		
J1939 message	TSC1, CM1, GC1		
Idle mode	●		
50/60 Hz frequency selection	●		
Shutdown override	-		
Diagnostic messages			
DM1 Yellow lamp	●		
DM1 Red lamp	●		
DM1 Protect	●		
DM1 Malfunction	●		
DM2	●		
Emissions			
Tier 4/Stage V	●		
Force regeneration	●		
Inhibit regeneration	●		
Analogue readings*			
Engine speed	●	Inlet temperature	●
Percent load	●	Exhaust temperature	●
Oil pressure	●	Fuel pressure	●
Oil temperature	●	Fuel temperature	●
Coolant pressure	●	Water in fuel	●
Coolant temperature	●	Fuel consumption/rate (L/h)	●
Turbo pressure	●	Fuel used (L)	●
Atmospheric pressure	●	Battery voltage	●
Engine hours	●	Battery potential (voltage)	●

NOTE *External equipment can read all of these from the AGC Modbus server. Other EIC analogue readings may also be available.

3.11 ISUZU

3.11.1 Isuzu ECM

ECU(s)	ECM		
Engine(s)	4JJ1X, 4JJ1T, 6WG1X FT-4		
Engine interface protocol (parameter 7561)	Isuzu		
EIC control			
Start	-		
Stop	-		
Speed control	●		
Default speed control source address	3		
J1939 message	TSC1		
Idle mode	1000 rpm		
50/60 Hz frequency selection	●		
Shutdown override	-		
Proprietary message(s)			
Diagnostic messages			
DM1 Yellow lamp	●		
DM1 Red lamp	●		
DM1 Protect	●		
DM1 Malfunction	●		
DM2	●		
Emissions			
Tier 4/Stage V	●		
Force regeneration	-		
Inhibit regeneration	Escape mode		
Analogue readings*			
Engine speed	●	Inlet temperature	●
Percent load	-	Exhaust temperature	●
Oil pressure	●	Fuel pressure	-
Oil temperature	●	Fuel temperature	●
Coolant pressure	-	Water in fuel	-
Coolant temperature	●	Fuel consumption/rate (L/h)	●
Turbo pressure	-	Fuel used (L)	●
Atmospheric pressure	●	Battery voltage	●
Engine hours	-	Battery potential (voltage)	●

NOTE *External equipment can read all of these from the AGC Modbus server. Other EIC analogue readings may also be available.

Write commands

Use parameter 7563 (EIC Controls) to enable write commands.

Isuzu write commands

Command	Description
Speed control	In general, this is the same as the J1939 command . By default, the governor offset is 50 % of the nominal speed. At 0 % it is -90 RPM, and at 100 % it is +90 RPM.
Idle speed	In general, this is the same as the J1939 command . However, the idle speed is 1000 RPM.
Start/Stop	See the J1939 command .
EIC start/stop enable	See the J1939 command .

Escape mode

Escape mode is a shutdown override. It will keep the engine running for the configured time, even if the DEF (Diesel Exhaust Fluid) level is critically low.

Configure escape mode in menu 15000 *Isuzu ESCmode SD thr*.

Use parameter 15002 to Enable (or Disable) escape mode. Alternatively, activate the M-Logic output *EIC commands, EIC Isuzu Escape mode command*.

Parameter 15001 is the timer for Escape mode. When the timer runs out, the AGC starts the engine stop sequence.

Purge function

The AGC ensures that the purge meets the requirements. That is, during the purge the genset must be running in island mode or the breaker is open, and the engine speed is 1800 RPM. The AGC also meets the requirements for the time since engine starting, and the time since the purge request.

The following events are available in M-Logic under *Events, EIC event*. The M-Logic events are activated by an Isuzu proprietary telegram.

Purge function M-Logic events

Event	Description
Isuzu Manual Purge ECU activated (status)	A manual purge is active in the ECU.
Isuzu Manual Purge E-IDSS activated (status)	E-IDSS (an Isuzu service PC tool) activated a manual purge.
Isuzu Force Purge activated (status)	A force purge is active.

Tier 4 aftertreatment support

For a general description, see [Tier 4/Stage V](#). Tier 4 is supported if the ECU is version 2.3 or later.

The TDU 107 supports aftertreatment for the Isuzu engine protocol. For Tier 4 icon dashboard handling, the yellow lamp icon is active for a malfunction lamp, and also if *EXH. SYSTEM Lamp* is received from 0x18FFE200.

Modbus analogue values

The readings below are available in the Modbus protocol. Generic J1939 Modbus readings may also be available.

Measurement table (read only) function code 04h

Address	Content	Unit	Scaling J1939	Description
860	EIC UREA Level	[%]	1/10	UREA Level
899	Inducement timer	[min]	1/1	The time for which the engine has been in escape mode. If the inducement timer exceeds the timer in parameter 15001, then the AGC shuts down the engine.

3.12 Iveco

3.12.1 Iveco CURSOR

ECU(s)	CURSOR		
Engine(s)	-		
Engine interface protocol (parameter 7561)	Iveco CURSOR		
EIC control			
Start	-		
Stop	-		
Speed control	●		
Default speed control source address	3		
J1939 message	TSC1		
Idle mode	●		
50/60 Hz frequency selection	●		
Shutdown override	-		
Proprietary message(s)	-		
Diagnostic messages			
DM1 Yellow lamp	●		
DM1 Red lamp	●		
DM1 Protect	●		
DM1 Malfunction	●		
DM2	●		
Emissions			
Tier 4/Stage V	-		
Force regeneration	-		
Inhibit regeneration	-		
Analogue readings*			
Engine speed	●	Inlet temperature	-
Percent load	●	Exhaust temperature	-
Oil pressure	●	Fuel pressure	●
Oil temperature	●	Fuel temperature	●
Coolant pressure	●	Water in fuel	-
Coolant temperature	●	Fuel consumption/rate (L/h)	-
Turbo pressure	●	Fuel used (L)	●
Atmospheric pressure	●	Battery voltage	-
Engine hours	●	Battery potential (voltage)	●

NOTE *External equipment can read all of these from the AGC Modbus server. Other EIC analogue readings may also be available.

3.12.2 Iveco NEF

ECU(s)	NEF		
Engine(s)	-		
Engine interface protocol (parameter 7561)	Iveco NEF		
EIC control			
Start	-		
Stop	-		
Speed control	●		
Default speed control source address	3		
J1939 message	TSC1		
Idle mode	●		
50/60 Hz frequency selection	●		
Shutdown override	-		
Proprietary message(s)	-		
Diagnostic messages			
DM1 Yellow lamp	●		
DM1 Red lamp	●		
DM1 Protect	●		
DM1 Malfunction	●		
DM2	●		
Emissions			
Tier 4/Stage V	-		
Force regeneration	-		
Inhibit regeneration	-		
Analogue readings*			
Engine speed	●	Inlet temperature	-
Percent load	●	Exhaust temperature	-
Oil pressure	●	Fuel pressure	●
Oil temperature	●	Fuel temperature	●
Coolant pressure	●	Water in fuel	-
Coolant temperature	●	Fuel consumption/rate (L/h)	-
Turbo pressure	●	Fuel used (L)	●
Atmospheric pressure	●	Battery voltage	-
Engine hours	●	Battery potential (voltage)	●

NOTE *External equipment can read all of these from the AGC Modbus server. Other EIC analogue readings may also be available.

3.12.3 Iveco EDC7 (Bosch MS6.2)

ECU(s)	EDC7 (Bosch MS6.2)		
Engine(s)	-		
Engine interface protocol (parameter 7561)	Iveco EDC7		
EIC control			
Start	-		
Stop	-		
Speed control	●		
Default speed control source address	3		
J1939 message	TSC1		
Idle mode	●		
50/60 Hz frequency selection	●		
Shutdown override	-		
Proprietary message(s)	-		
Diagnostic messages			
DM1 Yellow lamp	●		
DM1 Red lamp	●		
DM1 Protect	●		
DM1 Malfunction	●		
DM2	●		
Emissions			
Tier 4/Stage V	-		
Force regeneration	-		
Inhibit regeneration	-		
Analogue readings*			
Engine speed	●	Inlet temperature	-
Percent load	●	Exhaust temperature	-
Oil pressure	●	Fuel pressure	●
Oil temperature	●	Fuel temperature	●
Coolant pressure	●	Water in fuel	-
Coolant temperature	●	Fuel consumption/rate (L/h)	-
Turbo pressure	●	Fuel used (L)	●
Atmospheric pressure	●	Battery voltage	-
Engine hours	●	Battery potential (voltage)	●

NOTE *External equipment can read all of these from the AGC Modbus server. Other EIC analogue readings may also be available.

3.12.4 Iveco VECTOR 8

ECU(s)	VECTOR 8		
Engine(s)	-		
Engine interface protocol (parameter 7561)	Iveco Vector8		
EIC control			
Start	-		
Stop	-		
Speed control	●		
Default speed control source address	3		
J1939 message	TSC1		
Idle mode	●		
50/60 Hz frequency selection	●		
Shutdown override	-		
Proprietary message(s)	-		
Diagnostic messages			
DM1 Yellow lamp	●		
DM1 Red lamp	●		
DM1 Protect	●		
DM1 Malfunction	●		
DM2	●		
Emissions			
Tier 4/Stage V	-		
Force regeneration	-		
Inhibit regeneration	-		
Analogue readings*			
Engine speed	●	Inlet temperature	-
Percent load	●	Exhaust temperature	-
Oil pressure	●	Fuel pressure	●
Oil temperature	●	Fuel temperature	●
Coolant pressure	●	Water in fuel	-
Coolant temperature	●	Fuel consumption/rate (L/h)	-
Turbo pressure	●	Fuel used (L)	●
Atmospheric pressure	●	Battery voltage	-
Engine hours	●	Battery potential (voltage)	●

NOTE *External equipment can read all of these from the AGC Modbus server. Other EIC analogue readings may also be available.

3.12.5 Iveco Generic

ECU(s)	EDC7 (Bosch MS6.2), and VECTOR 8		
Engine(s)	-		
Engine interface protocol (parameter 7561)	Iveco Generic		
EIC control			
Start	VECTOR 8		
Stop	VECTOR 8		
Speed control	●		
Default speed control source address	3		
J1939 message	TSC1		
Idle mode	●		
50/60 Hz frequency selection	●		
Shutdown override	-		
Proprietary message(s)	Engine control (VECTOR 8)		
Diagnostic messages			
DM1 Yellow lamp	●		
DM1 Red lamp	●		
DM1 Protect	●		
DM1 Malfunction	●		
DM2	●		
Emissions			
Tier 4/Stage V	-		
Force regeneration	-		
Inhibit regeneration	-		
Analogue readings*			
Engine speed	●	Inlet temperature	-
Percent load	●	Exhaust temperature	-
Oil pressure	●	Fuel pressure	●
Oil temperature	●	Fuel temperature	●
Coolant pressure	●	Water in fuel	-
Coolant temperature	●	Fuel consumption/rate (L/h)	-
Turbo pressure	●	Fuel used (L)	●
Atmospheric pressure	●	Battery voltage	-
Engine hours	●	Battery potential (voltage)	●

NOTE *External equipment can read all of these from the AGC Modbus server. Other EIC analogue readings may also be available.

3.12.6 Iveco Bosch MD1

ECU(s)	Bosch MD1		
Engine(s)	-		
Engine interface protocol (parameter 7561)	Iveco Stage V		
EIC control			
Start	-		
Stop	●		
Speed control	●		
Default speed control source address	39		
J1939 message	TSC1, CM1		
Idle mode	●		
50/60 Hz frequency selection	●		
Shutdown override	-		
Proprietary message(s)	VCM2ECM, BC2EDC2		
Diagnostic messages			
DM1 Yellow lamp	●		
DM1 Red lamp	●		
DM1 Protect	●		
DM1 Malfunction	●		
DM2	●		
Emissions			
Tier 4/Stage V	●		
Force regeneration	●		
Inhibit regeneration	●		
Analogue readings*			
Engine speed	●	Inlet temperature	-
Percent load	●	Exhaust temperature	-
Oil pressure	●	Fuel pressure	-
Oil temperature	●	Fuel temperature	●
Coolant pressure	-	Water in fuel	●
Coolant temperature	●	Fuel consumption/rate (L/h)	●
Turbo pressure	●	Fuel used (L)	●
Atmospheric pressure	●	Battery voltage	●
Engine hours	●	Battery potential (voltage)	●

NOTE *External equipment can read all of these from the AGC Modbus server. Other EIC analogue readings may also be available.

3.12.7 Warnings and shutdowns

Warning and shutdown list	J1939 codes		
	SPN	FMI warning	FMI shutdown
Low oil pressure	100	17	1
Intake manifold #1 P	102	15	-
Coolant temperature	110	15	0
High inlet air temp.	172	15	-
Fuel temperature	174	15	-
Overspeed	190	15	0

NOTE If FMI is "-" the alarm is not supported.

3.12.8 Write commands

Use parameter 7563 (EIC Controls) to enable write commands.

Iveco write commands

Command	Description
Speed control	In general, this is the same as the J1939 command .
Idle speed	See the J1939 command .

Iveco Vector 8 write commands

Command	Description
Frequency control	The AGC regulates the frequency by adjusting the governor set point for the ECU.
EIC start/stop enable	See the J1939 command .

3.12.9 J1939 measurements

See the J1939 description for the measurements that the AGC supports. Values specific to Iveco are listed below.

Text	PGN	S	L	P	SPN	Unit	J1939-71 scaling	Offset
EIC coolant temp.	65282	5	1	6	110	°C	1 °C/bit	-40 °C
EIC oil temp.	65282	6	1	6	175	°C	0.03125 °C/bit	-273 °C
EIC oil pressure ¹	65282	7	1	6	100	bar	8 kPa/bit	0

NOTE 1: Range: 0 to 2000 kPa.

3.12.10 Modbus alarms

Alarm, status and measurement table (read only) function code 04h.

Addr.	Content	Bit	Type
1020	EIC alarms, DEIF controller	0	7570 EIC communication error
		1	7580 EIC warning
		2	7590 EIC shutdown
		3	7600 EIC overspeed
		4	7610 EIC coolant water temperature 1
		5	7620 EIC coolant water temperature 2
		6	7630 EIC oil pressure 1
		7	7640 EIC oil pressure 2
		8	7650 EIC oil temp. 1
		9	7660 EIC oil temp. 2
		10	7670 EIC coolant level 1
1024	EIC alarms, engine controller (DM1)	0	EIC communication error
		1	EIC low oil pressure, warning
		2	EIC low oil pressure, shutdown
		3	EIC boost pressure, warning
		4	EIC high coolant temperature, warning
		5	EIC low coolant level, shutdown
		6	EIC high inlet air temperature, warning
		7	EIC fuel temperature, warning
		8	EIC ECU yellow lamp, warning
		9	EIC ECU red lamp, shutdown
		10	EIC overspeed, warning
		11	EIC overspeed, shutdown
		12	EIC protection
13	EIC malfunction		

3.13 JCB

3.13.1 JCB

ECU(s)	-		
Engine(s)	ECOMAX DCM3.3+		
Engine interface protocol (parameter 7561)	JCB		
EIC control			
Start	-		
Stop	-		
Speed control	●		
Default speed control source address	3		
J1939 message	TSC1, CM1		
Idle mode			
50/60 Hz frequency selection	●		
Shutdown override	-		
Proprietary message(s)			
Diagnostic messages			
DM1 Yellow lamp	●		
DM1 Red lamp	●		
DM1 Protect	●		
DM1 Malfunction	●		
DM2	●		
Emissions			
Tier 4/Stage V	●		
Force regeneration	●		
Inhibit regeneration	●		
Analogue readings*			
Engine speed	●	Inlet temperature	●
Percent load	-	Exhaust temperature	●
Oil pressure	●	Fuel pressure	●
Oil temperature	●	Fuel temperature	●
Coolant pressure	-	Water in fuel	●
Coolant temperature	●	Fuel consumption/rate (L/h)	●
Turbo pressure	●	Fuel used (L)	●
Atmospheric pressure	●	Battery voltage	●
Engine hours	●	Battery potential (voltage)	●

NOTE *External equipment can read all of these from the AGC Modbus server. Other EIC analogue readings may also be available.

3.13.2 JCB 430/448 Stage V

ECU(s)	-		
Engine(s)			
Engine interface protocol (parameter 7561)	JCB 430/448		
EIC control			
Start	-		
Stop	-		
Speed control	●		
Default speed control source address	3		
J1939 message	TSC1, CM1		
Idle mode			
50/60 Hz frequency selection	●		
Shutdown override	-		
Proprietary message(s)			
Diagnostic messages			
DM1 Yellow lamp	●		
DM1 Red lamp	●		
DM1 Protect	●		
DM1 Malfunction	●		
DM2	●		
Emissions			
Tier 4/Stage V	●		
Force regeneration	●		
Inhibit regeneration	●		
Analogue readings*			
Engine speed	●	Inlet temperature	●
Percent load	-	Exhaust temperature	●
Oil pressure	●	Fuel pressure	●
Oil temperature	●	Fuel temperature	●
Coolant pressure	-	Water in fuel	●
Coolant temperature	●	Fuel consumption/rate (L/h)	●
Turbo pressure	●	Fuel used (L)	●
Atmospheric pressure	●	Battery voltage	●
Engine hours	●	Battery potential (voltage)	●

NOTE *External equipment can read all of these from the AGC Modbus server. Other EIC analogue readings may also be available.

3.14 Jichai

3.14.1 Jichai JC15D-ECU22

ECU(s)	JC15D-ECU22		
Engine(s)	-		
Engine interface protocol (parameter 7561)	JC15D Weifu**		
EIC control			
Start	-		
Stop	-		
Speed control	-		
Default speed control source address	-		
J1939 message	-		
Idle mode	-		
50/60 Hz frequency selection	-		
Shutdown override	-		
Proprietary message(s)	-		
Diagnostic messages			
DM1 Yellow lamp	●		
DM1 Red lamp	●		
DM1 Protect	●		
DM1 Malfunction	●		
DM2			
Emissions			
Tier 4/Stage V			
Force regeneration			
Inhibit regeneration			
Analogue readings*			
Engine speed	●	Inlet temperature	●
Percent load	-	Exhaust temperature	-
Oil pressure	●	Fuel pressure	-
Oil temperature	●	Fuel temperature	●
Coolant pressure	-	Water in fuel	-
Coolant temperature	●	Fuel consumption/rate (L/h)	●
Turbo pressure	●	Fuel used (L)	●
Atmospheric pressure	-	Battery voltage	-
Engine hours	●	Battery potential (voltage)	●

NOTE *External equipment can read all of these from the AGC Modbus server. Other EIC analogue readings may also be available.

NOTE ** Previously *Jichai*

NOTE See also *Displaying proprietary text for SPN/FMI combinations*.

3.14.2 Jichai JC15D WYS

ECU(s)	JC15D WYS		
Engine(s)	-		
Engine interface protocol (parameter 7561)	JC15D WYS		
EIC control			
Start	-		
Stop	-		
Speed control	-		
Default speed control source address	-		
J1939 message	-		
Idle mode	-		
50/60 Hz frequency selection	-		
Shutdown override	-		
Proprietary message(s)	-		
Diagnostic messages			
DM1 Yellow lamp	-		
DM1 Red lamp	-		
DM1 Protect	-		
DM1 Malfunction	-		
DM2	-		
Emissions			
Tier 4/Stage V			
Force regeneration			
Inhibit regeneration			
Analogue readings*			
Engine speed	●	Inlet temperature	-
Percent load	-	Exhaust temperature	-
Oil pressure	●	Fuel pressure	-
Oil temperature	●	Fuel temperature	●
Coolant pressure	-	Water in fuel	-
Coolant temperature	●	Fuel consumption/rate (L/h)	●
Turbo pressure	●	Fuel used (L)	-
Atmospheric pressure	-	Battery voltage	●
Engine hours	-	Battery potential (voltage)	-

NOTE *External equipment can read all of these from the AGC Modbus server. Other EIC analogue readings may also be available.

3.14.3 Jichai JC190

ECU(s)	JC190		
Engine(s)	-		
Engine interface protocol (parameter 7561)	JC190		
EIC control			
Start	-		
Stop	-		
Speed control	-		
Default speed control source address	-		
J1939 message	-		
Idle mode	-		
50/60 Hz frequency selection	-		
Shutdown override	-		
Proprietary message(s)	-		
Diagnostic messages			
DM1 Yellow lamp	●		
DM1 Red lamp	●		
DM1 Protect	●		
DM1 Malfunction	●		
DM2			
Emissions			
Tier 4/Stage V			
Force regeneration			
Inhibit regeneration			
Analogue readings*			
Engine speed	●	Inlet temperature	-
Percent load	-	Exhaust temperature	-
Oil pressure	●	Fuel pressure	-
Oil temperature	●	Fuel temperature	●
Coolant pressure	-	Water in fuel	-
Coolant temperature	●	Fuel consumption/rate (L/h)	-
Turbo pressure	●	Fuel used (L)	-
Atmospheric pressure	-	Battery voltage	●
Engine hours	-	Battery potential (voltage)	-

NOTE *External equipment can read all of these from the AGC Modbus server. Other EIC analogue readings may also be available.

NOTE See also *Displaying proprietary text for SPN/FMI combinations*.

3.14.4 Jichai JC15T JG

ECU(s)	Jichai JC15T JG		
Engine(s)	-		
Engine interface protocol (parameter 7561)	Jichai JC15T JG		
EIC control			
Start	-		
Stop	-		
Speed control	-		
Default speed control source address	-		
J1939 message	-		
Idle mode	-		
50/60 Hz frequency selection	-		
Shutdown override	-		
Proprietary message(s)	-		
Diagnostic messages			
DM1 Yellow lamp	●		
DM1 Red lamp	●		
DM1 Protect	●		
DM1 Malfunction	●		
DM2	●		
Emissions			
Tier 4/Stage V	-		
Force regeneration	-		
Inhibit regeneration	-		
Analogue readings*			
Engine speed	●	Inlet temperature	-
Percent load	-	Exhaust temperature	-
Oil pressure	-	Fuel pressure	-
Oil temperature	-	Fuel temperature	-
Coolant pressure	-	Water in fuel	-
Coolant temperature	●	Fuel consumption/rate (L/h)	-
Turbo pressure	●	Fuel used (L)	-
Atmospheric pressure	-	Battery voltage	-
Engine hours	●	Battery potential (voltage)	●

NOTE *External equipment can read all of these from the AGC Modbus server. Other EIC analogue readings may also be available.

3.15 Jing Guan

3.15.1 Jing Guan

ECU(s)	-		
Engine(s)			
Engine interface protocol (parameter 7561)	Jing Guan		
EIC control			
Start	-		
Stop	-		
Speed control	-		
Default speed control source address	-		
J1939 message	-		
Idle mode	-		
50/60 Hz frequency selection	-		
Shutdown override	-		
Proprietary message(s)	-		
Diagnostic messages			
DM1 Yellow lamp	●		
DM1 Red lamp	●		
DM1 Protect	●		
DM1 Malfunction	●		
DM2	●		
Emissions			
Tier 4/Stage V	-		
Force regeneration	-		
Inhibit regeneration	-		
Analogue readings*			
Engine speed	●	Inlet temperature	-
Percent load	-	Exhaust temperature	●
Oil pressure	●	Fuel pressure	-
Oil temperature	●	Fuel temperature	-
Coolant pressure	-	Water in fuel	-
Coolant temperature	●	Fuel consumption/rate (L/h)	-
Turbo pressure	●	Fuel used (L)	-
Atmospheric pressure	-	Battery voltage	-
Engine hours	-	Battery potential (voltage)	●

NOTE *External equipment can read all of these from the AGC Modbus server. Other EIC analogue readings may also be available.

3.16 John Deere

3.16.1 John Deere PowerTech M, E and Plus

ECU(s)	JDEC		
Engine(s)	PowerTech M, E and Plus		
Engine interface protocol (parameter 7561)	John Deere		
EIC control			
Start	-		
Stop	-		
Speed control	●		
Default speed control source address	3		
J1939 message	TSC1, CM1		
Idle mode	●		
50/60 Hz frequency selection	●		
Shutdown override	-		
Proprietary message(s)	Stationary Regeneration		
Diagnostic messages			
DM1 Yellow lamp	●		
DM1 Red lamp	●		
DM1 Protect	●		
DM1 Malfunction	●		
DM2	●		
Emissions			
Tier 4/Stage V	●		
Force regeneration	●		
Inhibit regeneration	●		
Analogue readings*			
Engine speed	●	Inlet temperature	●
Percent load	●	Exhaust temperature	-
Oil pressure	●	Fuel pressure	●
Oil temperature	-	Fuel temperature	●
Coolant pressure	●	Water in fuel	-
Coolant temperature	●	Fuel consumption/rate (L/h)	●
Turbo pressure	●	Fuel used (L)	●
Atmospheric pressure	●	Battery voltage	●
Engine hours	●	Battery potential (voltage)	●

NOTE *External equipment can read all of these from the AGC Modbus server. Other EIC analogue readings may also be available.

3.16.2 John Deere FOCUS controls

ECU(s)	FOCUS controls (version 2.1)		
Engine(s)	-		
Engine interface protocol (parameter 7561)	John Deere Stage V		
EIC control			
Start	-		
Stop	-		
Speed control	●		
Default speed control source address	17		
J1939 message	TSC1, CM1		
Idle mode	●		
50/60 Hz frequency selection	●		
Shutdown override	-		
Proprietary message(s)	Stationary Regeneration		
Diagnostic messages			
DM1 Yellow lamp	●		
DM1 Red lamp	●		
DM1 Protect	●		
DM1 Malfunction	●		
DM2	●		
Emissions			
Tier 4/Stage V	●		
Force regeneration	●		
Inhibit regeneration	●		
Analogue readings*			
Engine speed	●	Inlet temperature	●
Percent load	●	Exhaust temperature	-
Oil pressure	●	Fuel pressure	●
Oil temperature	-	Fuel temperature	●
Coolant pressure	●	Water in fuel	-
Coolant temperature	●	Fuel consumption/rate (L/h)	●
Turbo pressure	●	Fuel used (L)	●
Atmospheric pressure	●	Battery voltage	●
Engine hours	●	Battery potential (voltage)	●

NOTE *External equipment can read all of these from the AGC Modbus server. Other EIC analogue readings may also be available.

3.16.3 Warnings and shutdowns

Warning and shutdown list	J1939 codes		
	SPN	FMI warning	FMI shutdown
Low oil pressure	100	18	1
Intake manifold	105	16	-
Coolant temperature	110	16	0
Fuel injection pump	1076	10	6
Fuel temperature	174	-	16
ECU failure	2000	-	6

NOTE If FMI is "-" the alarm is not supported.

3.16.4 Write commands

Use parameter 7563 (EIC Controls) to enable write commands.

John Deere JDEC write commands

Command	Description
Speed control	See the J1939 command .
Idle speed	See the J1939 command .
Frequency selection (50 or 60 Hz)	See the J1939 command .
Regeneration	The command is activated through M-Logic: <i>Output, EIC commands, EIC JDEC Stationary regeneration setting</i> .

3.16.5 Tier 4 aftertreatment support

For a general description, see [Tier 4/Stage V](#).

JDEC includes special handling for regeneration. You can also use parameter 7720 for regeneration.

3.16.6 Modbus alarms

Alarm, status and measurement table (read-only) function code 04h.

Addr.	Content	Bit	Type
1020	EIC alarms, DEIF controller	0	7570 EIC communication error
		1	7580 EIC warning
		2	7590 EIC shutdown
		3	7600 EIC overspeed
		4	7610 EIC coolant water temperature 1
		5	7620 EIC coolant water temperature 2
		6	7630 EIC oil pressure 1
		7	7640 EIC oil pressure 2
		8	7650 EIC oil temp. 1
		9	7660 EIC oil temp. 2
		10	7670 EIC coolant level 1
		11	7680 EIC coolant level 2
1024	EIC alarms, engine controller (DM1)	0	EIC high coolant temperature, shutdown
		1	EIC low oil pressure, shutdown
		2	EIC fuel temperature, shutdown
		3	EIC fuel control valve, shutdown
		4	EIC ECU failure, shutdown
		5	EIC oil pressure, warning
		6	EIC intake manifold, warning
		7	EIC coolant temperature, warning
		8	EIC fuel injection pump, warning
		9	EIC JDEC shutdown (LS: lamp status)
		10	EIC JDEC warning (LS: lamp status)
		11	EIC communication error
		12	EIC protection
		13	EIC malfunction

3.17 Kohler

3.17.1 Kohler KD62V12

ECU(s)	ECU2-HD		
Engine(s)	KD62V12		
Engine interface protocol (parameter 7561)	Kohler KD62V12		
EIC control			
Start	-		
Stop	-		
Speed control	●		
Default speed control source address	3		
J1939 message	TSC1, CM1		
Idle mode	●		
50/60 Hz frequency selection	●		
Shutdown override	-		
Proprietary message(s)			
Diagnostic messages			
DM1 Yellow lamp	●		
DM1 Red lamp	●		
DM1 Protect	●		
DM1 Malfunction	●		
DM2	●		
Emissions			
Tier 4/Stage V	●		
Force regeneration	●		
Inhibit regeneration	●		
Analogue readings*			
Engine speed	●	Inlet temperature	-
Percent load	●	Exhaust temperature	-
Oil pressure	●	Fuel pressure	-
Oil temperature	-	Fuel temperature	●
Coolant pressure	-	Water in fuel	●
Coolant temperature	●	Fuel consumption/rate (L/h)	●
Turbo pressure	●	Fuel used (L)	●
Atmospheric pressure	●	Battery voltage	●
Engine hours	●	Battery potential (voltage)	●

NOTE *External equipment can read all of these from the AGC Modbus server Other EIC analogue readings may also be available.

NOTE See also *Displaying proprietary text for SPN/FMI combinations*.

3.17.2 Kohler KDI 3404

ECU(s)			
Engine(s)			
Engine interface protocol (parameter 7561)		Kohler KDI 3404	
EIC control			
Start		●	
Stop		●	
Speed control		●	
Default speed control source address		3	
J1939 message		TSC1, CM1, GC1	
Idle mode		●	
50/60 Hz frequency selection		●	
Shutdown override		-	
Proprietary message(s)		-	
Diagnostic messages			
DM1 Yellow lamp		●	
DM1 Red lamp		●	
DM1 Protect		●	
DM1 Malfunction		●	
DM2		●	
Emissions			
Tier 4/Stage V		●	
Force regeneration		●	
Inhibit regeneration		●	
Analogue readings*			
Engine speed	●	Inlet temperature	●
Percent load	●	Exhaust temperature	●
Oil pressure	●	Fuel pressure	●
Oil temperature	●	Fuel temperature	●
Coolant pressure	●	Water in fuel	●
Coolant temperature	●	Fuel consumption/rate (L/h)	●
Turbo pressure	●	Fuel used (L)	●
Atmospheric pressure	●	Battery voltage	●
Engine hours	●	Battery potential (voltage)	●

NOTE *External equipment can read all of these from the AGC Modbus server. Other EIC analogue readings may also be available.

3.17.3 Write commands

Use parameter 7563 (EIC Controls) to enable write commands.

Kohler write commands

Command	Description
Speed control	See the J1939 command .
EIC start/stop enable	See the J1939 command .

3.17.4 ECU reset

The Kohler ECU needs to be reset after it has been on for a number of hours. If the ECU reset function is enabled, when the AGC gets a signal from the ECU, the AGC disconnects the power to the ECU (if the engine is not running).

If an AGC-4 Mk II is used, it must have option M12. The parameters for this function are in menu 15010 (Kohler ECU Reset).

Wiring

The Reset signal from the ECU must be connected to terminal 43 on the AGC.

Use a digital output relay to disconnect the ECU power. The relay must be configured as normally closed.

Wiring for the ECU reset function

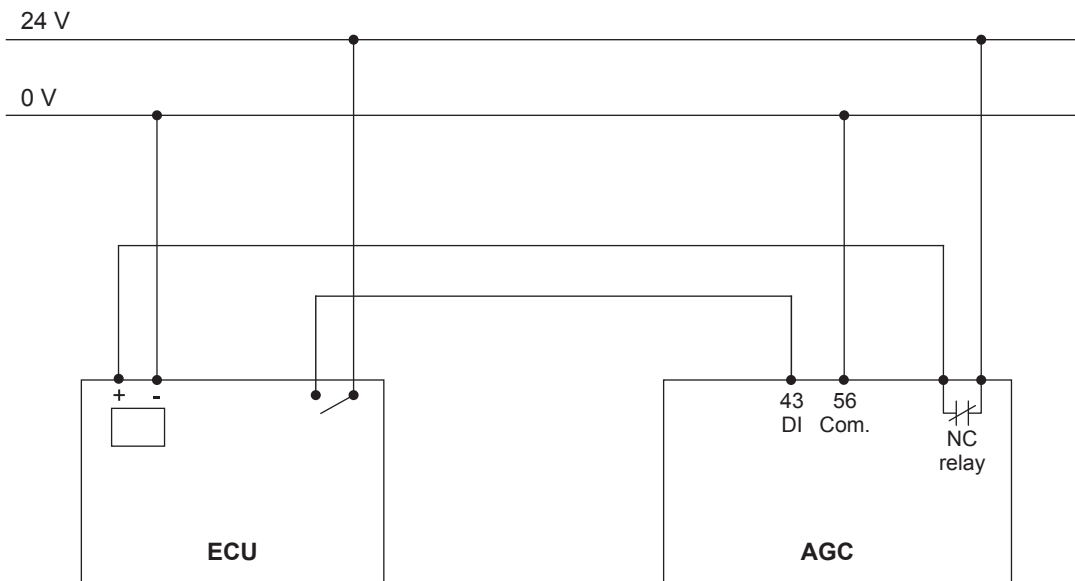

Parameters

Enable the function in parameter 15014.

Select the reset relay in parameter 15012/15013 (Output A/Output B).

When the function is activated, the reset relay opens, thus disconnecting ECU power for the period of time stated in parameter 15011 (the default setting is 5 s).

How it works

If the ECU does not need a reset soon, the relay in the ECU is open.

If the ECU needs a reset soon, the ECU closes the ECU relay. The AGC ignores the digital input when it is continuously closed.

If the ECU relay opens and closes once every second, an ECU reset is required. If the engine is not running, the AGC opens the AGC relay to disconnect power to the ECU.

NOTE See also *Displaying proprietary text for SPN/FMI combinations*.

3.18 Kubota

3.18.1 Kubota KORD3

ECU(s)	KORD3		
Engine(s)	-		
Engine interface protocol (parameter 7561)	Kubota Stage V		
EIC control			
Start	-		
Stop	●		
Speed control	●		
Default speed control source address	228		
J1939 message	TSC1, CM1, CCVS1, ETC5		
Idle mode	●		
50/60 Hz frequency selection	●		
Shutdown override	-		
Proprietary message(s)	Stationary Regeneration		
Diagnostic messages			
DM1 Yellow lamp	●		
DM1 Red lamp	●		
DM1 Protect	●		
DM1 Malfunction	●		
DM2	●		
Emissions			
Tier 4/Stage V	●		
Force regeneration	●		
Inhibit regeneration	●		
Analogue readings*			
Engine speed	●	Inlet temperature	●
Percent load	●	Exhaust temperature	-
Oil pressure	●	Fuel pressure	-
Oil temperature		Fuel temperature	●
Coolant pressure		Water in fuel	●
Coolant temperature	●	Fuel consumption/rate (L/h)	●
Turbo pressure	●	Fuel used (L)	●
Atmospheric pressure	●	Battery voltage	-
Engine hours	●	Battery potential (voltage)	●

NOTE *External equipment can read all of these from the AGC Modbus server. Other EIC analogue readings may also be available.

3.18.2 M-Logic

Events

The following additional event is available in M-Logic under *Events, EIC event* for Kubota.

Event	Description
Kubota oil switch	Proprietary event.

Commands

The following additional command is available in M-Logic under *Output, EIC commands* for Kubota.

Event	Description
EIC Kubota Parking brake switch	Proprietary command.

3.19 MAN

3.19.1 MAN EDC17

ECU(s)	EDC17		
Engine(s)			
Engine interface protocol (parameter 7561)	MAN EDC17		
EIC control			
Start	●		
Stop	●		
Speed control	●		
Default speed control source address	3		
J1939 message	TSC1, CM1, GC1		
Idle mode	●		
50/60 Hz frequency selection	●		
Shutdown override	-		
Diagnostic messages			
DM1 Yellow lamp	●		
DM1 Red lamp	●		
DM1 Protect	●		
DM1 Malfunction	●		
DM2	●		
Emissions			
Tier 4/Stage V	●		
Force regeneration	●		
Inhibit regeneration	●		
Analogue readings*			
Engine speed	●	Inlet temperature	●
Percent load	●	Exhaust temperature	●
Oil pressure	●	Fuel pressure	●
Oil temperature	●	Fuel temperature	●
Coolant pressure	●	Water in fuel	●
Coolant temperature	●	Fuel consumption/rate (L/h)	●
Turbo pressure	●	Fuel used (L)	●
Atmospheric pressure	●	Battery voltage	●
Engine hours	●	Battery potential (voltage)	●

NOTE *External equipment can read all of these from the AGC Modbus server. Other EIC analogue readings may also be available.

3.19.2 MAN EMC 2.0

ECU(s)	EMC 2.0		
Engine(s)			
Engine interface protocol (parameter 7561)	MAN EMC Step 2.0		
EIC control			
Start	●		
Stop	●		
Speed control	●		
Default speed control source address	3		
J1939 message			
Idle mode	●		
50/60 Hz frequency selection	●		
Shutdown override	-		
Proprietary message(s)	KSM		
Diagnostic messages			
DM1 Yellow lamp	●		
DM1 Red lamp	●		
DM1 Protect	●		
DM1 Malfunction	●		
DM2	-		
Emissions			
Tier 4/Stage V	-		
Force regeneration	-		
Inhibit regeneration	-		
Analogue readings*			
Engine speed	●	Inlet temperature	-
Percent load	●	Exhaust temperature	●
Oil pressure	●	Fuel pressure	-
Oil temperature	●	Fuel temperature	●
Coolant pressure	-	Water in fuel	-
Coolant temperature	●	Fuel consumption/rate (L/h)	●
Turbo pressure	●	Fuel used (L)	●
Atmospheric pressure	●	Battery voltage	-
Engine hours	●	Battery potential (voltage)	●

NOTE *External equipment can read all of these from the AGC Modbus server. Other EIC analogue readings may also be available.

3.19.3 MAN EMC 2.5

ECU(s)	EMC 2.5		
Engine(s)			
Engine interface protocol (parameter 7561)	MAN EMC Step 2.5		
EIC control			
Start	●		
Stop	●		
Speed control	●		
Default speed control source address	3		
J1939 message			
Idle mode	●		
50/60 Hz frequency selection	●		
Shutdown override	-		
Proprietary message(s)	KSM		
Diagnostic messages			
DM1 Yellow lamp	●		
DM1 Red lamp	●		
DM1 Protect	●		
DM1 Malfunction	●		
DM2	-		
Emissions			
Tier 4/Stage V	-		
Force regeneration	-		
Inhibit regeneration	-		
Analogue readings*			
Engine speed	●	Inlet temperature	-
Percent load	●	Exhaust temperature	●
Oil pressure	●	Fuel pressure	-
Oil temperature	●	Fuel temperature	●
Coolant pressure	-	Water in fuel	-
Coolant temperature	●	Fuel consumption/rate (L/h)	●
Turbo pressure	●	Fuel used (L)	●
Atmospheric pressure	●	Battery voltage	-
Engine hours	●	Battery potential (voltage)	●

NOTE *External equipment can read all of these from the AGC Modbus server. Other EIC analogue readings may also be available.

3.19.4 MAN Generic

ECU(s)	EMC 2.0 and 2.5		
Engine(s)			
Engine interface protocol (parameter 7561)	MAN Generic		
EIC control			
Start	●		
Stop	●		
Speed control	●		
Default speed control source address	3		
J1939 message			
Idle mode	●		
50/60 Hz frequency selection	●		
Shutdown override	-		
Proprietary message(s)	KSM		
Diagnostic messages			
DM1 Yellow lamp	●		
DM1 Red lamp	●		
DM1 Protect	●		
DM1 Malfunction	●		
DM2	-		
Emissions			
Tier 4/Stage V	-		
Force regeneration	-		
Inhibit regeneration	-		
Analogue readings*			
Engine speed	●	Inlet temperature	-
Percent load	●	Exhaust temperature	●
Oil pressure	●	Fuel pressure	-
Oil temperature	●	Fuel temperature	●
Coolant pressure	-	Water in fuel	-
Coolant temperature	●	Fuel consumption/rate (L/h)	●
Turbo pressure	●	Fuel used (L)	●
Atmospheric pressure	●	Battery voltage	-
Engine hours	●	Battery potential (voltage)	●

NOTE *External equipment can read all of these from the AGC Modbus server. Other EIC analogue readings may also be available.

3.20 MTU (J1939)

3.20.1 MTU J1939 Smart Connect

ECU(s)	J1939 Smart Connect, ECU8, ECU9		
Engine(s)	Series 1600		
Engine interface protocol (parameter 7561)	MTU J1939 Smart Connect		
EIC control			
Start	●		
Stop	●		
Speed control	●		
Default speed control source address	234		
J1939 message	TSC1, RESET, OHECS		
Idle mode	●		
50/60 Hz frequency selection	●		
Shutdown override	●		
Proprietary message(s)	Speed Start/Stop, Droop		
Diagnostic messages			
DM1 Yellow lamp	●		
DM1 Red lamp	●		
DM1 Protect	●		
DM1 Malfunction	●		
DM2	●		
Emissions			
Tier 4/Stage V	ECU9 or later		
Force regeneration	●		
Inhibit regeneration	●		
Analogue readings*			
Engine speed	●	Inlet temperature	-
Percent load	-	Exhaust temperature	-
Oil pressure	●	Fuel pressure	-
Oil temperature	-	Fuel temperature	-
Coolant pressure	●	Water in fuel	-
Coolant temperature	●	Fuel consumption/rate (L/h)	●
Turbo pressure	-	Fuel used (L)	●
Atmospheric pressure	-	Battery voltage	●
Engine hours	●	Battery potential (voltage)	-

NOTE *External equipment can read all of these from the AGC Modbus server. Other EIC analogue readings may also be available.

NOTE See also *Displaying proprietary text for SPN/FMI combinations*.

3.20.2 MTU ECU8

ECU(s)	ECU8		
Engine(s)			
Engine interface protocol (parameter 7561)	MTU ECU8		
EIC control			
Start	●		
Stop	●		
Speed control	●		
Default speed control source address	234		
J1939 message	TSC1, RESET, OHECS		
Idle mode	●		
50/60 Hz frequency selection	●		
Shutdown override	●		
Proprietary message(s)	Speed Start/Stop, Droop		
Diagnostic messages			
DM1 Yellow lamp	●		
DM1 Red lamp	●		
DM1 Protect	●		
DM1 Malfunction	●		
DM2	●		
Emissions			
Tier 4/Stage V	-		
Force regeneration	-		
Inhibit regeneration	-		
Analogue readings*			
Engine speed	●	Inlet temperature	-
Percent load	-	Exhaust temperature	-
Oil pressure	●	Fuel pressure	-
Oil temperature	-	Fuel temperature	-
Coolant pressure	●	Water in fuel	-
Coolant temperature	●	Fuel consumption/rate (L/h)	●
Turbo pressure	-	Fuel used (L)	●
Atmospheric pressure	-	Battery voltage	●
Engine hours	●	Battery potential (voltage)	-

NOTE *External equipment can read all of these from the AGC Modbus server. Other EIC analogue readings may also be available.

3.20.3 MTU ECU9

ECU(s)	ECU9		
Engine(s)			
Engine interface protocol (parameter 7561)	MTU J1939 Smart Connect		
EIC control			
Start	●		
Stop	●		
Speed control	●		
Default speed control source address	234		
J1939 message	TSC1, RESET, OHECS		
Idle mode	●		
50/60 Hz frequency selection	●		
Shutdown override	●		
Proprietary message(s)	Speed Start/Stop, Droop		
Diagnostic messages			
DM1 Yellow lamp	●		
DM1 Red lamp	●		
DM1 Protect	●		
DM1 Malfunction	●		
DM2	●		
Emissions			
Tier 4/Stage V	●		
Force regeneration	●		
Inhibit regeneration	●		
Analogue readings*			
Engine speed	●	Inlet temperature	-
Percent load	-	Exhaust temperature	-
Oil pressure	●	Fuel pressure	-
Oil temperature	-	Fuel temperature	-
Coolant pressure	●	Water in fuel	-
Coolant temperature	●	Fuel consumption/rate (L/h)	●
Turbo pressure	-	Fuel used (L)	●
Atmospheric pressure	-	Battery voltage	●
Engine hours	●	Battery potential (voltage)	-

NOTE *External equipment can read all of these from the AGC Modbus server. Other EIC analogue readings may also be available.

NOTE See also *Displaying proprietary text for SPN/FMI combinations*.

3.20.4 Alarm texts

These alarm texts are only supported for ECU9.

DEIF Display	MTU	SPN	FMI
SD Feedback Thrott A	SD Feedback Throttle A	51	11
AI Req Angle Throt A	AI Req Angle Throttle A	51	15
AL mixture throt A f	AL mixture throttle A fault	51	31
SS T-Coolant Interco	SS T-Coolant Intercooler	52	0
SD T-Coolant InterC	SD T-Coolant Intercooler	52	11
HI T-Coolant Interco	HI T-Coolant Intercooler	52	15
SS P-Fuel	SS P-Fuel	94	1
SD P-Fuel before Fil	SD P-Fuel before Filter	94	11
LO P-Fuel	LO P-Fuel	94	17
SS P-Diff-Fuel	SS P-Diff-Fuel	95	0
SD P-Diff Fuel	SD P-Diff Fuel	95	11
HI P-Diff-Fuel	HI P-Diff-Fuel	95	15
SD Level W.Fuel PreF	SD Level Water Fuel Prefilter	97	11
HI Level W.Fuel PreF	HI Level Water Fuel Prefilter	97	15
AL L2 Level Lube oil	AL L2 Level Lube Oil J1939	98	1
SD Level Lube oil	SD Level Lube Oil J1939	98	11
SD Level Lube oil	SD Level Lube Oil	98	11
AL L1 Level Lube Oil	AL L1 Level Lube Oil J1939	98	17
SS P-Diff-Lube Oil	SS P-Diff-Lube Oil	99	0
SD P-Diff Lube Oil	SD P-Diff Lube Oil	99	11
HI P-Diff-Lube Oil	HI P-Diff-Lube Oil	99	15
SS P-Lube Oil	SS P-Lube Oil	100	1
SD P-Lube Oil	SD P-Lube Oil	100	11
LO P-Lube Oil	LO P-Lube oil	100	17
SS P-Crank Case	SS P-Crank Case	101	0
LOLO P-Crank Case	LOLO P-Crank Case	101	1
SD P-CrankCase	SD P-CrankCase	101	11
HI P-Crank Case	HI P-Crank Case	101	15
LO P-Crank Case	LO P-Crank Case	101	17
HIHI P-Charge Mix A	HIHI P-Charge Mix A	102	0
SD P-Charge Mix A	SD P-Charge Mix A	102	11
SS ETC1 Overspeed	SS ETC1 Overspeed	103	0
SD Charger 1 Speed	SD Charger 1 Speed	103	11
HI ETC1 Overspeed	HI ETC1 Overspeed	103	15
AL L2 P-Lubeoil ETCA	AL L2 P-Lubeoil ETC A	104	1
SD-P-Lubeoil ETC A	SD-P-Lubeoil ETC A	104	11

DEIF Display	MTU	SPN	FMI
AL L1 P-Lubeoil ETCA	AL L1 P-Lubeoil ETC A	104	17
HIHI T-Charge Mix	HIHI T-Charge Mix	105	0
HIHI T-Intake Air	HIHI T-Intake Air	105	0
SS T-Charge Air	SS T-Charge Air	105	0
SD T-Charge Air	SD T-Charge Air	105	11
SD T-Charge Mix	SD T-Charge Mix	105	11
HI T-Charge Mix	HI T-Charge Mix	105	15
HI T-Charge Air	HI T-Charge-air	105	15
HI T-Intake Air	HI T-Intake Air	105	15
LO T-Charge Mix	LO T-Charge Mix	105	17
SD P-Intake Air Filt	SD P-Intake Air Filter Diff.	107	11
SD P-AmbientAirT2800	SD P-Ambient Air (HDT2800)	108	11
SS P-Coolant	SS P-Coolant	109	1
SD P-Coolant	SD P-Coolant	109	11
HI P-Coolant	HI P-Coolant	109	15
LO P-Coolant	LO P-Coolant	109	17
SS T-Coolant L4	SS T-Coolant L4	110	0
SD T-Coolant	SD T-Coolant	110	11
HI T-Coolant	HI T-Coolant	110	15
SS T-Coolant	SS T-Coolant	110	16
ALL2 Lev Cool. Water	AL L2 Level Coolant Water	111	1
SD Level Coolant W.	SD Level Coolant Water	111	11
ALL1 Lev Coola Water	AL L1 Level Coolant Water	111	17
LO Coolant Level	LO Coolant Level	111	17
SD P-Coolant Diff	SD P-Coolant Diff	112	11
LO P-Coolant Diff	LO P-Coolant Diff	112	17
SD P-HD	SD P-HD	157	11
HI P-Fuel (ComRail)	HI P-Fuel (Common Rail)	157	15
LO P-Fuel (ComRail)	LO P-Fuel (Common Rail)	157	17
HIHI ECU PS Voltage	HIHI ECU Power Supply Voltage	158	0
LOLO ECU PS Voltage	LOLO ECU Power Supply Voltage	158	1
SD ECU PS Voltage	SD ECU Power Supply Voltage	158	11
HI ECU PS Voltage	HI ECU Power Supply Voltage	158	15
LO ECU PS Voltage	LO ECU Power Supply Voltage	158	17
SD T0-AmbientAir	SD T0-Ambient Air (HDT2800)	171	11
LOLO T-Intake Air	LOLO T-Intake Air	172	1
SD T-Intake Air	SD T-Intake Air	172	11
LO T-Intake Air	LO T-Intake Air	172	17
SD-T-Exh. after Eng.	SD-T-Exh. after Engine	173	11

DEIF Display	MTU	SPN	FMI
AL L1 T-Exh. aft.Eng	AL L1 T	173	17
AL L2 T-Fuel b.Eng.	AL L2 T-Fu	174	0
SS T-Fuel	SS T-Fuel	174	0
AL T-Gas L2	AL T-Gas L2	174	1
SD T-Fuel	SD T-Fuel	174	11
SD T-Fuel b.Engine	SD T-Fu	174	11
SD T-Gas	SD T-Gas	174	11
AL L1 T-Fuel b.Eng.	AL L1 T-Fu	174	15
HI T-Fuel	HI T-Fuel	174	15
AL T-Gas L1	AL T-Gas L1	174	17
SS T-Lube Oil	SS T-Lube Oil	175	0
SD T-Lube Oil	SD T-Lube Oil	175	11
HI T-Lube Oil	HI T-Lube Oil	175	15
AL L2 T-Lubeoil ETC	AL L2 T-Lubeoil ETC	176	0
SD-T-Lubeoil ETC	SD-T-Lubeoil ETC	176	11
AL L1 T-Lubeoil ETC	AL L1 T-Lubeoil ETC	176	15
SS Idle Sp.N Reac	SS Idle Speed Not Reached	188	1
SS Engine Overspeed	SS Engine Overspeed	190	0
SS Engine Speed tool	SS Engine Speed too Low	190	1
AL Eng Hours Cnt def	AL Eng Hours Counter Defect	247	31
AL Fuel Cons.Cnt def	AL Fuel Cons. Counter Defect	250	31
AL L1 T-Aux 1	AL L1 T-Aux 1	441	15
AL L2 T-Aux2	AL L2 T-Aux2	442	0
AL L1 T-Aux 2	AL L1 T-Aux 2	442	15
AL Comb. Alarm Red	AL Comb. Alarm Red (Plant)	623	31
AL Comb. Alarm Yel	AL Comb. Alarm Yel (Plant)	624	31
SD Speed Demand	SD Speed Demand	898	11
AL Develop PR Set	AL Develop PR Set	966	31
AL L2 Aux1	AL L2 Aux1	1083	0
SD AUX 1	SD AUX 1	1083	11
AL L1 Aux 1	AL L1 Aux 1	1083	15
AL L2 Aux2	AL L2 Aux2	1084	0
SD AUX 2	SD AUX 2	1084	11
AL L1 Aux 2	AL L1 Aux 2	1084	15
AL HIHI T-ChargeAirB	AL HIHI T-Charge Air B	1131	0
SD T-Charge Air B	SD T-Charge Air B	1131	11
AL HI T-Charge Air B	AL HI T-Charge Air B	1131	15
SD T-ECU	SD T-ECU	1136	11
HI T-ECU	HI T-ECU	1136	15

DEIF Display	MTU	SPN	FMI
AL L2 P-Lubeoil ETCB	AL L2 P-Lubeoil ETC B	1168	1
AL L1 P-Lubeoil ETCB	AL L1 P-Lubeoil ETC B	1168	17
SD P-Lube Oil (R2)	SD P-Lube Oil (R2)	1168	31
SD-P-Lubeoil ETC B	SD-P-Lubeoil ETC B	1168	31
SS ETC2 Overspeed	SS ETC2 Overspeed	1169	0
SD Charger 2 Speed	SD Charger 2 Speed	1169	11
HI ETC2 Overspeed	HI ETC2 Overspeed	1169	15
SS ETC3 Overspeed	SS ETC3 Overspeed	1170	0
SD Charger 3 Speed	SD Charger 3 Speed	1170	11
HI ETC3 Overspeed	HI ETC3 Overspeed	1170	15
SS ETC4 Overspeed	SS ETC4 Overspeed	1171	0
SD Charger 4 Speed	SD Charger 4 Speed	1171	11
HI ETC4 Overspeed	HI ETC4 Overspeed	1171	15
ALL2TExh.bef.TurbA1	AL L2 T-Exh. bef. HP Turbine A1	1172	1
ALL1TExh.bef.TurbA1	AL L1 T-Exh. bef. HP Turbine A1	1172	17
AL L2 P-IntakeA a.FA	AL L2 P-Intake Air after Filter A	1176	1
AL L1 P-IntakeA a.FA	AL L1 P-Intake Air after Filter A	1176	17
AL L2 P-IntakeA a.FB	AL L2 P-Intake Air after Filter B	1177	1
AL L1 P-IntakeA a.FB	AL L1 P-Intake Air after Filter B	1177	17
SS P-Coolant InterC	SS P-Coolant InterCooler	1203	1
SD P-Coolant InterC	SD P-Coolant Intercooler	1203	11
LO P-Coolant InterC	LO P-Coolant InterCooler	1203	17
SD P-Lube Oil bef. F	SD P-Lube Oil before Filter	1208	11
AL Override applied	AL Override applied	1237	31
SD Level Leak. Fuel	SD Level Leakage Fuel	1239	11
HI Level LeakageFuel	HI Level Leakage Fuel	1239	15
SD P-HD2	SD P-HD2	1349	11
SD-P-Fuel before Eng	SD-P-Fuel before Engine	1349	11
HI P-Fuel 2(ComRail)	HI P-Fuel 2 (Common Rail)	1349	15
AL L1 P-Fuel bef.Eng	AL L1 P-Fuel before Engine	1349	17
LO P-Fuel 2(ComRail)	LO P-Fuel 2 (Common Rail)	1349	17
SD-Level Oil Refill	SD-Level Oil Refill Tank	1380	11
LO Oil Level Refill	LO Oil Level Refill	1380	17
AL L2 T-Aux1	AL L2 T-Aux1	1385	0
SD T-AUX 1	SD T-AUX 1	1385	11
SD T-AUX 2	SD T-AUX 2	1386	11
AL L2 P-Aux1	AL L2 P-Aux1	1387	1
SD P-AUX 1	SD P-AUX 1	1387	11
AL L1 P-Aux 1	AL L1 P-Aux 1	1387	17

DEIF Display	MTU	SPN	FMI
AL L2 P-Aux2	AL L2 P-Aux2	1388	1
SD P-AUX 2	SD P-AUX 2	1388	11
AL L1 P-Aux 2	AL L1 P-Aux 2	1388	17
Niveau RM Tank	Niveau RM Tank	1761	11
SS T-Exhaust B	SS T-Exhaust B	2433	0
SD T-Exhaust B	SD T-Exhaust B	2433	11
HI T-Exhaust B	HI T-Exhaust B	2433	15
SS T-Exhaust A	SS T-Exhaust A	2434	0
SD T-Exhaust A	SD T-Exhaust A	2434	11
HI T-Exhaust A	HI T-Exhaust A	2434	15
SD P-Ch MixbefThrott	SD P-Charge Mix before Throttle	2631	11
SD T-RM Tank	SD T-RM Tank	3031	11
HIHI Nox Value	HIHI Nox Value	3226	0
LOLO Nox Value	LOLO Nox Value	3226	1
SD Smart NOx Oxi.Fac	SD Smart NOx Oxidation Factor O2	3226	11
HI Nox Value	HI Nox Value	3226	15
LO Nox Value	LO Nox Value	3226	17
AL NOx ATO1Comm.lost	AL NOx ATO1 Communication Lost	3226	31
AL L2 T-Exhaust Bef.	AL L2 T-Exhaust Before DPF	3242	0
SD T-Exhaust bef.DPF	SD T-Exhaust before DPF A	3242	11
AL L1 T-Exhaust Bef.	AL L1 T-Exhaust Before DPF	3242	15
AL L2 T-ExhaustAfter	AL L2 T-Exhaust After DPF	3246	0
SD T-Exhaust a. DPF	SD T-Exhaust after DPF A	3246	11
AL L1 T-ExhaustAfter	AL L1 T-Exhaust After DPF	3246	15
AL L2 P-DPF Diff.	AL L2 P-DPF Difference	3251	0
SD P-DeltaExhaustDPF	SD P-DeltaExhaust DPF A	3251	11
AL L1 P-DPF Diff.	AL L1 P-DPF Difference	3251	15
SS T-Fuel B	SS T-Fuel B	3468	0
SD-T-Fuel B	SD-T-Fuel B	3468	11
HI T-Fuel B	HI T-Fuel B	3468	15
AL Urea Qua Release	AL Urea Quality Release	3516	31
AL turning activated	AL turning activated	3543	31
HIHI P-Charge Mix B	HIHI P-Charge Mix B	3562	0
SD P-Charge Mix B	SD P-Charge Mix B	3562	11
SS P-Charge Air	SS P-Charge Air	3563	0
SD P-Charge Air	SD P-Charge Air	3563	11
HI P-Charge Air	HI P-Charge Air	3563	15
SD Level Cool.InterC	SD Level Coolant Intercooler	3668	11
LO Coolant LevelIntC	LO Coolant Level Intercooler	3668	17

DEIF Display	MTU	SPN	FMI
SD Feedback Thrott B	SD Feedback Throttle B	3673	11
AI Req Angle Throt B	AI Req Angle Throttle B	3673	15
AL mix throt B fault	AL mixture throttle B fault	3673	31
AL DPF Rigorous TM S	AL DPF Rigorous TM Suppression	3703	11
SD T-Coolant (R2)	SD T-Coolant (R2)	4076	31
SS T-Coolant bef Eng	SS T-Coolant before Engine	4193	0
SD T-Coolant b.Engine	SD T-Coolant b.Engine	4193	11
HI T-Coolant bef Eng	HI T-Coolant before Engine	4193	15
SD EngRPM 3rd Sensor	SD Engine Speed 3rd Sensor	4202	31
AL SCR F1 SU AdBlueQ	AL SCR F1 SU AdBlue Quantity	4348	15
AL L2 T-Exh.Bef.SCR1	AL L2 T-Exhaust Before SCR F1	4360	0
SD T-Exh bef. SCR F1	SD T-Exh before SCR F1	4360	11
SD T-Exh bef. SCR F3	SD T-Exh before SCR F3	4360	11
AL L1 T-Exh.Bef.SCR1	AL L1 T-Exhaust Before SCR F1	4360	15
AL F1 T-Exh bef.SCRL	AL F1 T-Exh before SCR too LOW	4360	17
AL L2 T-Exh.Aft.SCR1	AL L2 T-Exhaust After SCR F1	4363	0
SD T-Exh a. SCR F1	SD T-Exh after SCR F1	4363	11
SD T-Exh aft. SCR F3	SD T-Exh after SCR F3	4363	11
AL L1 T-Exh.Aft.SCR1	AL L1 T-Exhaust After SCR F1	4363	15
AL F1 T-Exh aft.SCRL	AL F1 T-Exh after SCR too LOW	4363	17
AL SCR F1 SU Rev. Ra	AL SCR F1 SU Revolution Range	4375	31
AL SCR F2 SU AdBlueQ	AL SCR F2 SU AdBlue Quantity	4401	15
AL L2 T-Exh.Bef.SCR2	AL L2 T-Exhaust Before SCR F2	4413	0
SD T-Exh bef. SCR F1	SD T-Exh before SCR F2	4413	11
AL L1 T-Exh.Bef.SCR2	AL L1 T-Exhaust Before SCR F2	4413	15
AL F2 T-Exh bef.SCRL	AL F2 T-Exh before SCR too LOW	4413	17
AL L2 T-Exh.Aft.SCR2	AL L2 T-Exhaust After SCR F2	4415	0
SD T-Exh a. SCR F2	SD T-Exh after SCR F2	4415	11
AL L1 T-Exh.Aft.SCR2	AL L1 T-Exhaust After SCR F2	4415	15
AL F2 T-Exh aft.SCRL	AL F2 T-Exh after SCR too LOW	4415	17
AL SCR F2 SU Rev. Ra	AL SCR F2 SU Revolution Range	4441	31
SD Air Humidity	SD Air Humidity	4490	11
SD Air Humidity	SD Air Humidity (HDT2800)	4490	11
AL Rel. Humidity L1	AL Rel. Humidity L1	4490	15
AL L2 T-Exhaust Bef.	AL L2 T-Exhaust Before DOC	4765	0
SD T-Exhaust bef.DOC	SD T-Exhaust before DOC A	4765	11
AL L1 T-Exhaust Bef.	AL L1 T-Exhaust Before DOC	4765	17
AL Battery Not Charg	AL Battery Not Charging	4990	31
AL L2 P-Charge Air B	AL L2 P-Charge Air B	5422	1

DEIF Display	MTU	SPN	FMI
AL L1 P-Charge Air B	AL L1 P-Charge Air B	5422	17
SD-P-Fuel Returnpath	SD-P-Fuel Return path	5571	11
AL L1 P-FuelRet.Path	AL L1 P-Fuel Return Path	5571	17
SD P-L Oil aft L. Pu	SD-P-Lube Oil aft Level Pump	520406	11
AL L1 P-OilNivPump	AL L1 P-OilNivPump	520406	17
AL Wiring TO 1	AL Wiring TO 1	520872	31
AL Selected Mode NV	AL Selected Mode not Valid	520873	31
AL No Valid ModeSw.S	AL No Valid Mode Switch Signal	520874	11
AL Speed Demand Fail	AL Speed Demand Failure	520875	31
AL SD Stop Button	AL SD Stop Button	520876	11
AL SD Start Button	AL SD Start Button	520877	11
AL SD Up Button	AL SD Up Button	520878	11
AL SD Down Button	AL SD Down Button	520879	11
AL SD Ext. Speed D_S	AL SD Ext. Speed Demand Switch	520880	11
AL SD Speed D Inc	AL SD Speed Demand Increase	520881	11
AL SD Bin Speed Lim	AL SD Binary Speed Limitation	520882	11
AL SD Droop 2 Switch	AL SD Droop 2 Switch	520883	11
AL SD Frequency SW	AL SD Frequency Switch	520884	11
AL SD Test Overspeed	AL SD Test Overspeed	520885	11
AL SD Override Butto	AL SD Override Button	520886	11
AL SD Alarm Reset	AL SD Alarm Reset	520887	11
AL SD Cylin CutOut	AL SD Cylinder Cut Out	520888	11
AL SD Request BinOut	AL SD Request BinOut Test	520889	11
AL SD Ext.Engine Pro	AL SD Ext. Engine Protection	520890	11
AL SD Prelubri. Sig.	AL SD Prelubrication Signal	520891	11
AL SD Ext.InclIdleBin	AL SD Ext. Increased Idle Bin	520892	11
AL SD Request P. DBR	AL SD Request Plant DBR	520893	11
AL Wiring Cylind.A1	AL Wiring Cylinder A1	520900	31
AL Wiring Cylind.A2	AL Wiring Cylinder A2	520901	31
AL Wiring Cylind.A3	AL Wiring Cylinder A3	520902	31
AL Wiring Cylind.A4	AL Wiring Cylinder A4	520903	31
AL Wiring Cylind.A5	AL Wiring Cylinder A5	520904	31
AL Wiring Cylind.A6	AL Wiring Cylinder A6	520905	31
AL Wiring Cylind.A7	AL Wiring Cylinder A7	520906	31
AL Wiring Cylind.A8	AL Wiring Cylinder A8	520907	31
AL Wiring Cylind.A9	AL Wiring Cylinder A9	520908	31
AL Wiring Cylind.A10	AL Wiring Cylinder A10	520909	31
AL Wiring Cylind.B1	AL Wiring Cylinder B1	520910	31
AL Wiring Cylind.B2	AL Wiring Cylinder B2	520911	31

DEIF Display	MTU	SPN	FMI
AL Wiring Cylind.B3	AL Wiring Cylinder B3	520912	31
AL Wiring Cylind.B4	AL Wiring Cylinder B4	520913	31
AL Wiring Cylind.B5	AL Wiring Cylinder B5	520914	31
AL Wiring Cylind.B6	AL Wiring Cylinder B6	520915	31
AL Wiring Cylind.B7	AL Wiring Cylinder B7	520916	31
AL Wiring Cylind.B8	AL Wiring Cylinder B8	520917	31
AL Wiring Cylind.B9	AL Wiring Cylinder B9	520918	31
AL Wiring Cylind.B10	AL Wiring Cylinder B10	520919	31
SS T-Coolant L3	SS T-Coolant L3	520923	0
AL Power too high	AL Power too high	520924	15
AL Open L.Cylind.A1	AL Open Load Cylinder A1	520930	31
AL Open L.Cylind.A2	AL Open Load Cylinder A2	520931	31
AL Open L.Cylind.A3	AL Open Load Cylinder A3	520932	31
AL Open L.Cylind.A4	AL Open Load Cylinder A4	520933	31
AL Open L.Cylind.A5	AL Open Load Cylinder A5	520934	31
AL Open L.Cylind.A6	AL Open Load Cylinder A6	520935	31
AL Open L.Cylind.A7	AL Open Load Cylinder A7	520936	31
AL Open L.Cylind.A8	AL Open Load Cylinder A8	520937	31
AL Open L.Cylind.A9	AL Open Load Cylinder A9	520938	31
AL Open L.Cylind.A10	AL Open Load Cylinder A10	520939	31
AL Open L.Cylind.B1	AL Open Load Cylinder B1	520940	31
AL Open L.Cylind.B2	AL Open Load Cylinder B2	520941	31
AL Open L.Cylind.B3	AL Open Load Cylinder B3	520942	31
AL Open L.Cylind.B4	AL Open Load Cylinder B4	520943	31
AL Open L.Cylind.B5	AL Open Load Cylinder B5	520944	31
AL Open L.Cylind.B6	AL Open Load Cylinder B6	520945	31
AL Open L.Cylind.B7	AL Open Load Cylinder B7	520946	31
AL Open L.Cylind.B8	AL Open Load Cylinder B8	520947	31
AL Open L.Cylind.B9	AL Open Load Cylinder B9	520948	31
AL Open L.Cylind.B10	AL Open Load Cylinder B10	520949	31
AL Wiring TOP 1	AL Wiring TOP 1	520952	31
AL Wiring TOP 2	AL Wiring TOP 2	520953	31
AL Wiring TOP 3	AL Wiring TOP 3	520954	31
AL Wiring TOP 4	AL Wiring TOP 4	520955	31
AL Open Load DI 1	AL Open Load Digital Input 1	520958	31
AL Open Load DI 2	AL Open Load Digital Input 2	520959	31
AL Open Load DI 3	AL Open Load Digital Input 3	520960	31
AL Open Load DI 4	AL Open Load Digital Input 4	520961	31
AL Open Load DI 5	AL Open Load Digital Input 5	520962	31

DEIF Display	MTU	SPN	FMI
AL Open Load DI 6	AL Open Load Digital Input 6	520963	31
AL Open Load DI 7	AL Open Load Digital Input 7	520964	31
AL Open Load DI 8	AL Open Load Digital Input 8	520965	31
AL Wiring PWM_CM1	AL Wiring PWM_CM1	520970	31
AL Wiring PWM_CM2	AL Wiring PWM_CM2	520971	31
AL Wiring PWM_CM3	AL Wiring PWM_CM3	520972	31
AL Wiring PWM_CM4	AL Wiring PWM_CM4	520973	31
AL Wiring PWM_CM5	AL Wiring PWM_CM5	520974	31
AL Wiring PWM_CM6	AL Wiring PWM_CM6	520975	31
AL Wiring PWM_CM7	AL Wiring PWM_CM7	520976	31
AL Wiring PWM_CM8	AL Wiring PWM_CM8	520977	31
AL Wiring PWM_CM9	AL Wiring PWM_CM9	520978	31
AL Wiring PWM_CM10	AL Wiring PWM_CM10	520979	31
HIHI U-PDU	HIHI U-PDU	520982	0
LOLO U-PDU	LOLO U-PDU	520982	1
SD U-PDU	SD U-PDU	520982	11
HI U-PDU	HI U-PDU	520982	15
LO U-PDU	LO U-PDU	520982	17
AL Wiring Suct. Res1	AL Wiring Suction Restrictor 1	520983	31
AL Wiring Suct. Res2	AL Wiring Suction Restrictor 2	520984	31
AL Wiring Pres.CV 1	AL Wiring Pressure Control Valve 1	520985	31
AL Wiring Pres.CV 2	AL Wiring Pressure Control Valve 2	520986	31
AL Crash Rec. Init.	AL Crash Rec. Init. Error	520990	31
AL ECUPower OFF/ON R	AL ECU Power OFF/ON Required	520991	31
AL OL ASO FlapFeedbB	AL OL ASO Flap Feedback B	520994	11
AL ASOFlapB cl. Aerr	AL ASO Flap B closed, A failed	520995	11
AL OL ASO FlapFeedbA	AL OL ASO Flap Feedback A	520996	31
AL ASOFlapA cl. Aerr	AL ASO Flap A closed, B failed	520997	31
AL ASO Flaps Closed	AL ASO Flaps Closed	520998	31
AL ASOFlaps open/err	AL ASO Flaps open / failed to close	520999	31
AL ASO Flap A Not Cl	AL ASO Flap A Not Closed by ECU	521000	31
AL Rail Leakage	AL Rail Leakage	521001	31
SS Release Sp.N Reac	SS Release Speed Not Reached	521002	1
SS Starter Sp.N Reac	SS Starter Speed Not Reached	521003	1
SS T-Preheat	SS T-Preheat	521004	1
LO T-Preheat	LO T-Preheat	521004	17
AL ASO Flap B Not Cl	AL ASO Flap B Not Closed by ECU	521005	31
AL CAN1 Node Lost	AL CAN1 Node Lost	521006	31
AL CAN2 Node Lost	AL CAN2 Node Lost	521007	31

DEIF Display	MTU	SPN	FMI
AL CAN Wrong Param.	AL CAN Wrong Parameters	521008	31
AL CAN No PU-Data	AL CAN No PU-Data	521009	31
AL CAN PU-Data Flash	AL CAN PU-Data Flash Error	521010	31
AL CAN1 Bus Off	AL CAN1 Bus Off	521011	31
AL CAN1 Error Pass.	AL CAN1 Error Passive	521012	31
AL CAN2 Bus Off	AL CAN2 Bus Off	521013	31
AL CAN2 Error Pass.	AL CAN2 Error Passive	521014	31
AL Stop Camsh. S def	AL Stop Camshaft Sensor Defect	521016	31
SD Crankshaft Speed	SD Crankshaft Speed	521017	11
SD Camshaft Speed	SD Camshaft Speed	521018	11
SD Frequency Input	SD Frequency Input	521019	11
AL Power Stage Low	AL Power Stage Low	521020	31
AL Power Stage High	AL Power Stage High	521021	31
AL Stop Power Stage	AL Stop Power Stage	521022	31
AL L2 Aux1 Plant	AL L2 Aux1 Plant	521023	0
AL L1 Aux1 Plant	AL L1 Aux1 Plant	521023	15
AL Stop MVWiring GND	AL Stop MV-Wiring Ground	521023	31
AL Open Load Emerg.	AL Open Load Emerg. Stop Input ESI	521024	31
SD Idle/End-TorqueIN	SD Idle/End-Torque Input [%]	521025	11
SS Power Reduct. Act	SS Power Reduction Active	521026	31
AL Stop SD	AL Stop SD	521027	31
AL Wiring FO	AL Wiring FO	521028	31
AL Wiring PWM_CM2	AL Wiring PWM_CM2	521028	31
AL Ext. Engine Prot.	AL Ext. Engine Protection	521029	31
AL Starter Not Engag	AL Starter Not Engaged	521030	31
AL Power Cut-Off det	AL Power Cut-Off detected	521031	31
AL ESCM Override	AL ESCM Override	521032	31
AL MD CANReq Idle S.	AL MD CAN Request Idle Speed	521033	31
AL MD CAN Speed Limi	AL MD CAN Speed Limitation	521034	31
AL L2 PRV Defect	AL L2 PRV Defect	521035	0
AL L1 PRV Defect	AL L1 PRV Defect	521035	15
AL L1 PRV Defect	AL L1 PRV Defect	521036	31
AL L2 PRV Defect	AL L2 PRV Defect	521037	31
SD ETC1+ETC2	SD ETC1+ETC2	521038	11
AL Doub.Nod. Lost1+2	AL Double Nodes Lost CAN 1 + 2	521039	31
AL EIL Protection	AL EIL Protection	521040	31
AL EIL Error	AL EIL Error	521041	31
AL EGR Throttle ADef	AL EGR Throttle A Defect	521042	31
AL Bypass Throt. Def	AL Bypass Throttle Defect	521043	31

DEIF Display	MTU	SPN	FMI
AL Dispen. Throt.Def	AL Dispenser Throttle Defect	521044	31
SD P-Exhaust Lambda	SD P-Exhaust Lambda	521045	11
SD P-Charge Air B	SD P-Charge Air B	521046	11
SD Smart NOx HeaterE	SD Smart NOx Heater Element	521047	11
SD Smart NOx Concent	SD Smart NOx Concentration	521048	11
AL Emission Fault	AL Emission Fault	521050	31
SD P-Fuel	SD P-Fuel	521052	11
AL L2L Voltage ASO	AL L2L Voltage ASO	521053	1
AL SD Voltage ASO	AL SD Voltage ASO	521053	11
AL L1L Voltage ASO	AL L1L Voltage ASO	521053	17
SD P-Ambient Air	SD P-Ambient Air	521060	11
AL Emerg. Stop fail	AL Emergency Stop Failed	521061	31
AL CAN Engine St.Loc	AL CAN Engine Start Lock	521062	31
SD P-Fuel bef. Add.s	SD P-Fuel bef. Add.sec.fuelfilter	521063	11
AL L1 P-Fuel Add.sec	AL L1 P-Fuel Add.sec.fuelfilt. Diff	521063	15
AL L2 P-Fuel b.o.F.	AL L2 P-Fuel b.o.F.	521064	0
SD P-Fuel b.o.F.	SD P-Fuel b.o.F.	521064	11
AL L1 P-Fuel b.o.F.	AL L1 P-Fuel b.o.F.	521064	15
AL Emission Warning	AL Emission Warning	521067	31
AL Gas Path Warning	AL Gas Path Warning	521068	31
AL Gas Path Fault	AL Gas Path Fault	521069	31
AL GPE Lambda v.inva	AL GPE Lambda value invalid	521070	31
AL NOx value invalid	AL NOx value invalid	521071	31
AL Thermal Manag.Act	AL Thermal Management active	521072	31
AL p5 ctrlvar LO Act	AL p5 ctrlvar lower limit active	521073	31
AL p5 ctrlvar max BO	AL p5 ctrlvar max BOI min active	521074	31
AL Lambda ctrlvar li	AL Lambda ctrlvar limit min active	521075	31
AL Lambda ctrlvar ma	AL Lambda ctrlvar max BOI min act	521076	31
AL Nox p5 min BOI ma	AL Nox p5 min BOI max active	521077	31
AL NOx p5 max BOI mi	AL NOx p5 max BOI min active	521078	31
AL GPS p5 ctrlvar ma	AL GPS p5 ctrlvar max active	521080	31
AL GPS p5 ctrlvar mi	AL GPS p5 ctrlvar min active	521081	31
AL GPS p5 ctrlvar mi	AL GPS p5 ctrlvar min active	521082	31
AL Bypass Throttle 2	AL Bypass Throttle 2 Defect	521083	31
AL Bypass Valve Def.	AL Bypass Valve Defect	521084	31
AL Intake AirThrottI	AL Intake AirThrottle Defect	521085	31
SD Bosch LSU LambdaS	SD Bosch LSU Lambda Sensor	521086	11
AL EGR Throttle BDef	AL EGR Throttle B Defect	521087	31
AL L2 Delta T-NT Int	AL L2 Delta T-NT Intercooler	521088	0

DEIF Display	MTU	SPN	FMI
AL L1 Delta T-NT Int	AL L1 Delta T-NT Intercooler	521088	17
AL Lim T-Coolant LT	AL Lim T-Coolant LT Fan	521089	31
AL ETC2 CutIn Failur	AL ETC2 CutIn Failure	521091	31
AL Prelubrication	AL Prelubrication Fault	521092	31
AL MCR exceeded 1h	AL MCR exceeded 1 hour	521093	31
AL EMU Parameter Not	AL EMU Parameter Not Supported	521094	31
SD Spinning Value	SD Spinning Value	521095	11
AL MCR exceeded	AL MCR exceeded	521096	31
AL Rail 2 Leakage	AL Rail 2 Leakage FMI-	521097	31
HI T-Exhaust EMU	HI T-Exhaust EMU	521098	15
LO T-Exhaust EMU	LO T-Exhaust EMU	521098	17
HI T-Coolant EMU	HI T-Coolant EMU	521099	15
SD Coil Current	SD Coil Current	521100	11
AL ETC4 CutIn Failur	AL ETC4 CutIn Failure	521103	31
AL ETC3 CutIn Failur	AL ETC3 CutIn Failure	521104	31
AL Wiring POM Starte	AL Wiring POM Starter 1	521105	11
AL Wiring POM Starte	AL Wiring POM Starter 2	521106	11
AL Open Load POM Alt	AL Open Load POM Alternator	521107	11
AL L1 T-Raw W a. Pum	AL L1 T-Raw water after Pump	521108	17
AL CAN POM Node Lost	AL CAN POM Node Lost	521109	11
AL Low Starter Volta	AL Low Starter Voltage	521110	1
AL POM Error	AL POM Error	521111	31
AL Wrong POM-ID	AL Wrong POM-ID	521112	31
Write Error Flash	Write Error Flash	521113	31
Oillevel Calibration	Oillevel Calibration Error	521114	31
SD P-Intake Air a.FA	SD P-Intake Air after Filter A	521115	11
SD P-Intake Air a.FB	SD P-Intake Air after Filter B	521116	11
SS Engine Oversp. CS	SS Engine Overspeed Camshaft	521117	0
SD T-Lube Oil Pan	SD T-Lube Oil Pan	521118	11
AL T-Lube Oil Pan LO	AL T-Lube Oil Pan Low	521118	17
SD P-Oil Refill Pump	SD P-Oil Refill Pump	521119	11
LO P-Oil Refill Pump	LO P-Oil Refill Pump	521119	17
SD T-Exhaust A+B	SD T-Exhaust A+B	521120	11
SD T-Lube Oil Pan	SD T-Lube Oil Pan J1939	521121	11
AL MB Valve error	AL MB Valve error	521122	31
AL L2 P-DPF Norm Dif	AL L2 P-DPF Norm Difference	521123	0
AL L4 P-DPF Norm Dif	AL L4 P-DPF Norm Difference	521123	1
AL L1 P-DPF Norm Dif	AL L1 P-DPF Norm Difference	521123	15
AL L3 P-DPF Norm Dif	AL L3 P-DPF Norm Difference	521123	17

DEIF Display	MTU	SPN	FMI
AL DPF Rigorous TM A	AL DPF Rigorous TM Aborted	521124	11
AL DPF Periodic Rigo	AL DPF Periodic Rigorous TM	521125	11
AL DPF Flash ReadErr	AL DPF Flash Read Error	521126	11
AL DEF Nozzle Damage	AL DEF Nozzle Damage	521127	11
AL SmartConnect Lost	AL Smart Connect Lost	521128	11
SD-T-Sea water a.Pum	SD-T-Sea water after Pump	521129	11
SD-P-LOil, HP Pump A	SD-P-Lube Oil at HP Pump A	521131	11
SD-P-LOil, HP Pump B	SD-P-Lube Oil at HP Pump B	521132	11
SD Charger 5 Speed	SD Charger 5 Speed	521133	11
AL F1 NOx bef. SCR	AL F1 NOx before SCR SensorDefect	521134	11
AL F1 NOx bef. SCR	AL F1 NOx before SCR Comm Lost	521134	31
AL F1 NOx a. SCR	AL F1 NOx after SCR SensorDefect	521135	11
AL F1 NOx a. SCR C	AL F1 NOx afterSCR Comm Lost	521135	31
AL F2 NOx bef. SCR	AL F2 NOx before SCR SensorDefect	521136	11
AL F2 NOx bef. SCR	AL F2 NOx before SCR Comm Lost	521136	31
AL F2 NOx a. SCR	AL F2 NOx after SCR SensorDefect	521137	11
AL F2 NOx a. SCR	AL F2 NOx after SCR Comm Lost	521137	31
AL F3 NOx bef. SCR	AL F3 NOx before SCR SensorDefect	521138	11
AL F3 NOx bef. SCR	AL F3 NOx before SCR Comm Lost	521138	31
AL F3 NOx a. SCR	AL F3 NOx after SCR SensorDefect	521139	11
AL F3 NOx a. SCR	AL F3 NOx after SCR Comm Lost	521139	31
HI ETC1 Idle Speed H	HI ETC1 Idle Speed too High	521140	31
HI ETC2 Idle Speed H	HI ETC2 Idle Speed too High	521141	31
HI ETC3 Idle Speed H	HI ETC3 Idle Speed too High	521142	31
HI ETC4 Idle Speed H	HI ETC4 Idle Speed too High	521143	31
HI ETC5 Idle Speed H	HI ETC5 Idle Speed too High	521144	31
AL ETC1 Speed Dev.	AL ETC1 Speed Deviation	521145	31
AL ETC2 Speed Dev.	AL ETC2 Speed Deviation	521146	31
AL ETC3 Speed Dev.	AL ETC3 Speed Deviation	521147	31
AL ETC4 Speed Dev.	AL ETC4 Speed Deviation	521148	31
AL ETC5 Speed Dev.	AL ETC5 Speed Deviation	521149	31
AL ETC Job Rotation	AL ETC Job Rotation	521150	31
AL EIL Different Eng	AL EIL Different Engine Number	521151	31
AL ash volume	AL ash volume	521152	31
AL HIHI T-ChargeAEGR	AL HIHI T-Charge Air before EGR	521153	0
AL HI T-ChargeAirEGR	AL HI T-Charge Air before EGR	521153	15
SD T-Charge Air bef.	SD T-Charge Air before EGR	521153	31
AL HIHI T-Char.ADAB	AL HIHI T-Charge Air Diff AB	521154	0
AL HI T-ChargeAirDAB	AL HI T-Charge Air Diff AB	521154	15

DEIF Display	MTU	SPN	FMI
AL Ext.Start, HD HI	AL External Start and HD too high	521155	31
AL Max. BlankShot TE	AL Max. Blank Shot time expired	521156	31
AL HSB1 Comm. lost	AL HSB1 Communication Lost	521157	31
AL HSB1 Actuat. def.	AL HSB1 Actuator defect	521158	31
AL NOx ATO1 Sen. Def	AL NOx ATO1 Sensor Defect	521159	31
AL HSB2 Comm. lost	AL HSB2 Communication Lost	521160	31
AL HSB2 Actuator def	AL HSB2 Actuator defect	521161	31
Defect DEFpns/act S	Defect in DEF pipe sns/act system	521162	31
DEF Tank ht. sns/act	DEF Tank ht. sns/act defect	521163	31
AL HSB3 Comm. lost	AL HSB3 Communication Lost	521164	31
AL HSB3 Actuator def	AL HSB3 Actuator defect	521165	31
AL HSB4 Comm. lost	AL HSB4 Communication Lost	521166	31
AL HSB4 Actuator def	AL HSB4 Actuator defect	521167	31
AL MB Valve defect 2	AL MB Valve defect 2	521168	31
AL EGR A Ref.learn	AL EGR A Reference learn failed	521169	31
AL Urea Tank L.Empty	AL Urea Tank Level Empty	521170	31
AL EGR B Ref. learn	AL EGR B Reference learn failed	521171	31
AL Bypass A Ref.	AL Bypass A Reference learn failed	521172	31
AL Bypass B Fast lea	AL Bypass B Fast learn failed	521173	31
AL Dispenser Ref.lea	AL Dispenser Reference learn failed	521174	31
AL Intake Thr. Ref L	AL Intake Throttle Ref learn failed	521175	31
AL SCR AdBlue press.	AL SCR AdBlue pressure	521176	31
AL Flow1 SU 1 Comm L	AL Flow 1 Supply Unit 1 Comm Lost	521177	31
AL Flow1 SU 2 Comm L	AL Flow 1 Supply Unit 2 Comm Lost	521178	31
AL Flow2 SU 1 Comm L	AL Flow 2 Supply Unit 1 Comm Lost	521179	31
AL Flow2 SU 2 Comm L	AL Flow 2 Supply Unit 2 Comm Lost	521180	31
AL Flow3 SU 1 Comm L	AL Flow 3 Supply Unit 1 Comm Lost	521181	31
AL Flow3 SU 2 Comm L	AL Flow 3 Supply Unit 2 Comm Lost	521182	31
AL Trican Comm. Lost	AL Trican Communication Lost	521183	31
AL OLT Comm. Lost	AL OLT Communication Lost	521184	31
AL SD T Coolant Cy.H	AL SD T Coolant at cylinder head	521187	11
HI T-Coolant Cy.Head	HI T-Coolant Cylinder Head	521187	15
SS T-Coolant Cyl. H	SS T-Coolant Cylinder Head	521187	16
AL F1 DEF consump.	AL F1 DEF consumption error	521188	31
AL F1 DEF balance	AL F1 DEF balance error	521189	31
AL F1 Raw gas emissi	AL F1 Raw gas emission error	521190	31
AL F1 NOx Annaeherun	AL F1 NOx Annaeherung error	521191	31
AL Texh bef SCR F1F2	AL T-Exh bef SCR between F1 and F2	521192	31
AL F1 Erw Tabg v SCR	AL F1 Erw T-Abg vor SCR Error	521193	31

DEIF Display	MTU	SPN	FMI
AL F1Exp TExh af SCR	AL F1 Exp T-Exh aft SCR error	521194	31
AL F1 gr TExh bf SCR	AL F1 grad T-Exh bef SCR error	521195	31
AL F2 gr TExh bf SCR	AL F2 grad T-Exh bef SCR error	521196	31
AL F1 gr TExh af SCR	AL F1 grad T-Exh aft SCR error	521198	31
AL F2 gr TExh af SCR	AL F2 grad T-Exh aft SCR error	521199	31
AL SCR F3 T-Exh aft.	AL SCR F3 T-Exh after gradient	521200	31
AL L2 T-Exh.Bef.SCR3	AL L2 T-Exhaust Before SCR F3	521201	0
AL L1 T-Exh.Bef.SCR3	AL L1 T-Exhaust Before SCR F3	521201	15
AL L2 T-Exh.Aft.SCR3	AL L2 T-Exhaust After SCR F3	521202	0
AL L1 T-Exh.Aft.SCR3	AL L1 T-Exhaust After SCR F3	521202	15
AL SCR oper. T TooLO	AL SCR operating temperature too-LOW	521203	17
AL Cataly conv. F1	AL Cataly conversion too lowF1	521204	17
AL Cataly conv. F2	AL Cataly conversion too lowF2	521205	17
AL Cataly conv. F3	AL Cataly conversion too lowF3	521206	17
AL Invalid LSI Ch.Co	AL Invalid LSI Channel Config	521207	31
AL SCR SU fault(s)	AL SCR SU fault(s) exist	521208	31
AL ETC0 CutIn Fail	AL ETC0 CutIn Failure	521209	31
AL ETC1 CutIn Fail	AL ETC1 CutIn Failure	521210	31
AL SCR SU fault(s)F2	AL SCR SU fault(s) exist F2	521211	31
AL SCR SU Prim. RF1	AL SCR SU Priming Request F1	521213	31
AL SCR SU Prim. RF2	AL SCR SU Priming Request F2	521214	31
AL L1 P-Oil bef. PuA	AL L1 P-Oil before HD Pump A	521216	17
AL L1 P-Oil bef. PuB	AL L1 P-Oil before HD Pump B	521217	17
SD Loadp.Analog filt	SD Loadp.Analog filt	521218	11
SD T-Intake Air B	SD T-Intake Air B	521219	11
SS P-Coolant befEng	SS P-Coolant before Engine	521220	1
SD P-Coolant b.Engine	SD P-Coolant b.Engine	521220	11
LO P-Coolant befEngi	LO P-Coolant before Engine	521220	17
SD P-Charge Mix Diff	SD P-Charge Mix Diff	521221	11
HI P-Charge Mix Diff	HI P-Charge Mix Diff	521221	31
HIHI P-ChargeMixDiff	HIHI P-Charge Mix Diff	521221	31
SD ele. Eng powerAI2	SD electr. engine power AI2	521222	31
AL CR Trig. Eng.Stop	AL CR Trigger Engine Stop	521223	31
HIHI Power Diff	HIHI Power Difference	521224	0
LOLO Power Diff	LOLO Power Difference	521224	1
AL GasControlCheck	AL GasControlCheck Fault	521225	31
AL Ignition Fault	AL Ignition Fault	521226	31
AL GasValve Fault	AL GasValve Fault	521227	31
AL EngineSpeedCollap	AL EngineSpeedCollapse Fault	521228	31

DEIF Display	MTU	SPN	FMI
AL SAM Missing Data	AL SAM Missing Data Fault	521229	31
L3 AI CANMaxRetar. T	L3 AI CAN Max. Retarded Timing	521235	0
L1 AI CANMaxRetar. T	L1 AI CAN Max. Retarded Timing	521235	15
L2 AI CANMaxRetar. T	L2 AI CAN Max. Retarded Timing	521235	16
AL Cir. Break closed	AL Circuit Breaker Closed	521236	31
AL Hut Changespeed M	AL Hut Changespeed	521237	31
HIHI Actual Value Hu	HIHI Actual Value Hu	521238	0
LOLO Actual Value Hu	LOLO Actual Value Hu	521238	1
HI Actual Value Hu	HI Actual Value Hu	521238	15
LO Actual Value Hu	LO Actual Value Hu	521238	17
AI Knock Intensity	AI Knock Intensity	521239	31
AL Preheating Error	AL Preheating Error	521240	31
AL GET Comm Lost	AL GET Comm Lost	521241	31
AL IC92x Comm Lost	AL IC92x Comm Lost	521242	31
AL FSeries Comm Lost	AL FSeries Comm Lost	521243	31
AL TecJet Comm Lost	AL TecJet Comm Lost	521244	31
AL ProActA Comm Lost	AL ProActA Comm Lost	521245	31
AL ProActB Comm Lost	AL ProActB Comm Lost	521246	31
AL NOxA Comm Lost	AL NOxA Comm Lost	521247	31
AL NOxB Comm Lost	AL NOxB Comm Lost	521248	31
AL Oil Refill Error	AL Oil Refill Error	521249	31
AL GET Yellow	AL GET Yellow	521250	31
AL IC92x Yellow	AL IC92x Yellow	521251	31
AL FSeries Yellow	AL FSeries Yellow	521252	31
AL TecJet Yellow	AL TecJet Yellow	521253	31
AL ProActA Yellow	AL ProActA Yellow	521254	31
AL ProActB Yellow	AL ProActB Yellow	521255	31
AL NOxA Yellow	AL NOxA Yellow	521256	31
AL NOxB Yellow	AL NOxB Yellow	521257	31
AL GET Red	AL GET Red	521258	31
AL IC92x Red	AL IC92x Red	521259	31
AL FSeries Red	AL FSeries Red	521260	31
AL TecJet Red	AL TecJet Red	521261	31
AL ProActA Red	AL ProActA Red	521262	31
AL ProActB Red	AL ProActB Red	521263	31
AL NOxA Red	AL NOxA Red	521264	31
AL NOxB Red	AL NOxB Red	521265	31
AL Lube Oil Min	AL Lube Oil Min	521266	31
AL Lube Oil Max	AL Lube Oil Max	521267	31

DEIF Display	MTU	SPN	FMI
LO Oil Refill	LO Oil Refill	521268	31
HI Oil Refill	HI Oil Refill	521269	31
HI Lube Oil L. Ref	HI Lube Oil Level refill	521270	31
AL ActFuelValvePosL1	AL ActFuelValvePos L1	521271	31
AL MIC5 Yellow	AL MIC5 Yellow	521272	31
AL MIC5 Red	AL MIC5 Red	521273	31
AL MIC5 Comm Lost	AL MIC5 Comm Lost	521274	31
AL ESI activated	AL ESI activated	521275	31
AL MIC5 Sign. diff	AL MIC5 Signature difference	521276	31
AL CAN3 Bus Off	AL CAN3 Bus Off	521277	31
AL CAN3 Error Pas	AL CAN3 Error Passive	521278	31
AL CAN4 Bus Off	AL CAN4 Bus Off	521279	31
AL CAN4 Error Pas	AL CAN4 Error Passive	521280	31
HIHI Delta NOx (A-B)	HIHI Delta NOx (A-B)	521297	0
HI Delta NOx (A-B)	HI Delta NOx (A-B)	521297	15
HI Delta p5 for NOx	HI Delta p5 for NOx	521298	15
AL MIC5 para. DL act	AL MIC5 parameter download active	521299	31
AL F2 DEF consumptio	AL F2 DEF consumption error	521332	31
AL F2 DEF balance	AL F2 DEF balance error	521333	31
AL F2 Raw gas emissi	AL F2 Raw gas emission error	521334	31
AL F2 Nox Annaeherun	AL F2 NOx Annaeherung error	521335	31
AL TExh af. SCR F1F2	AL T-Exh aft SCR between F1 and F2	521336	31
AL F2Exp TExh bf SCR	AL F2 Exp T-Exh bef SCR error	521337	31
AL F2Exp TExh af SCR	AL F2 Exp T-Exh aft SCR error	521338	31
AL SCRSU AdBlue Pres	AL SCR SU AdBlue Pressure	521350	31
AL Check Sum IIG	AL Check Sum IIG	521351	31
SS ETC5 Overspeed	SS ETC5 Overspeed	521352	0
HI ETC5 Overspeed	HI ETC5 Overspeed	521352	15
AL NOxATO2 Sens Def.	AL NOx ATO2 Sensor Defect	521353	11
AL Nox ATO2 Comm.err	AL NOx ATO2 Communication Lost	521353	19
AL DEF Tank Lev. low	AL DEF Tank Level low	521354	17
AL T.Breakd.NOx sen.	AL Total breakdown NOx sensors	521355	31
AL Redun.lossNOx sen	AL Redundancy loss NOx sensors	521356	31
AL Engine Cold Activ	AL Engine Cold Active	521357	31
AL Engine Cool. T.SD	AL Engine Coolant Temperature SD	521358	11
AL Intake Air T. SD	AL Intake Air Temperature SD	521359	11
AL DEF Tank T. SD	AL DEF Tank Temperature SD	521360	11
AL Engine Cool.V.DEF	AL Engine Coolant Valve Defect(DEF)	521361	31
AL Fl.EgrA Comm.lost	AL Flap Egr A Communication Lost	521362	31

DEIF Display	MTU	SPN	FMI
AL Fl.EgrA T.t. high	AL Flap Egr A Temperature too high	521363	0
AL Fl.EgrA Targ.pos	AL Flap Egr A Targetposition	521364	31
AL Fl.EgrB Comm.lost	AL Flap Egr B Communication Lost	521365	31
AL Fl.EgrB T.t. high	AL Flap Egr B Temperature too high	521366	0
AL Fl.EgrB Targ.pos	AL Flap Egr B Targetposition	521367	31
AL Fl.By.A Comm.lost	AL Flap BypassA Communication Lost	521368	31
AL Fl.By.A T.to.high	AL Flap BypassA Temperature too high	521369	0
AL Fl. By. A Tar.pos	AL Flap Bypass A Targetposition	521370	31
AL Fl.By B comm.lost	AL Flap BypassB Communication Lost	521371	31
AL Fl.By.B. T. high	AL Flap BypasB Temperature too high	521372	0
AL Fl.By B Tar.pos.	AL Flap Bypass B Targetposition	521373	31
AL Fl.Disp.Comm.lost	AL Flap Dispens Communication Lost	521374	31
AL Fl.Disp.T.toohigh	AL Flap DispensTemperature too high	521375	0
AL Fl. Disp. Tar.pos	AL Flap Dispenser Targetposition	521376	31
AL Fl. Int.Comm.lost	AL Flap Intake Communication Lost	521377	31
AL Fl.Int.T.too high	AL Flap Intake Temperature too high	521378	0
AL Fl.int.A Tar.pos.	AL Flap Intake Air Targetposition	521379	31
AL Fl.EgrA Calibr.Dr	AL Flap Egr A Calibration Drive Err	521380	31
AL Fl.EgrB Calibr.Dr	AL Flap Egr B Calibration Drive Err	521381	31
AL Fl.ByA Calibr. Dr	AL Flap BypassA Calibr. Drive Err	521382	31
AL Fl.By B Calibr. Dr	AL Flap BypassB Calibr. Drive Err	521383	31
AL Fl.Disp.Calibr Dr	AL Flap Dispenser Calibr Drive Err	521384	31
AL Fl.Int.A.Cali. Dr	AL Flap Intake Air Calibr Drive Err	521385	31
AL L2 PCV Defect	AL L2 PCV Defect	521386	0
AL L1 PCV Defect	AL L1 PCV Defect	521386	15
AL L2 PCV2 Defect	AL L2 PCV2 Defect	521387	0
AL L1 PCV2 Defect	AL L1 PCV2 Defect	521387	15
AL Short Cir.Ana.O 1	AL Short Circuit Analog Out 1	521388	6
AL Short Cir.Ana.O 2	AL Short Circuit Analog Out 2	521389	6

3.20.5 Tier 4 aftertreatment support

For a general description, see [Tier 4/Stage V](#). Tier 4 is supported if the MTU ECU is version 9 or later.

3.20.6 Write commands

Use parameter 7563 (EIC Controls) to enable write commands.

MTU J1939 Smart Connect write commands

Command	Description
Speed control	In general, this is the same as the J1939 command .
Idle speed	See the J1939 command .

Command	Description
Start/Stop*	<p>This sends the standard J1939 command to start the engine if it is stopped, and stops the engine if it is running. The AGC also sends the required proprietary MTU start-stop commands. In addition, the AGC ignores the M-Logic flags and also always sends the more advanced EIC start/stop enable command (see the M-Logic commands for details).</p> <p>The AGC determines whether to start or stop the engine. The decision is based on the AGC's inputs, logic and calculations.</p>
MTU alternate droop setting*	<p>If the M-Logic command (<i>Output, EIC Commands, EIC MTU Alternate Droop Setting</i>) is activated, the ACG commands the ECU to activate droop, using the setting in parameter 2771. The function is MTU-specific.</p>
Frequency selection (50 or 60 Hz)	<p>The AGC automatically writes the nominal frequency (50 or 60 Hz) to the ECU. The nominal frequency is defined in parameters 6001, 6011, 6021 and 6031. The AGC writes 50 Hz if the nominal frequency is less than 55 Hz, and 60 Hz if the nominal frequency is more than 55 Hz.</p> <p>Specifically, the AGC sends PGN GC1 0xFD93. On byte 4, the AGC writes 000 for 50 Hz, and 001 for 60 Hz.</p>
Demand switch	<p>Use menu 2790 to select the speed control type:</p> <ul style="list-style-type: none"> • Digital (<i>Up/down ECU</i> with relay controls) • Analogue (<i>Analog ECU Relative</i> for analogue VDC control) • J1939 commands (<i>Analog CAN</i>). <p>See the MTU documentation for the ECU8 for more information about switching between normal and emergency operation in local or remote.</p> <p>If the MTU ECU cannot detect a valid speed demand signal, it sends <i>AI Speed deman def.</i> This alarm indicates that the MTU ECU may see a CAN speed bias signal, and is setup to 3 - ADEC Analog Relative or that 4 - ADEC Analog relative is used and the signal is out of range (not connected, and so on).</p> <p>When this happens, check the settings on the MTU ECU, PR500 (MTU SAM/Diasys reference)</p> <p>0 - Default dataset ADEC 1 - ADEC Increase/Decrease Input 2 - CAN Increase/Decrease Input 3 - ADEC Analog Absolute 4 - ADEC Analog Relative 5 - ADEC Frequency Input 6 - CAN Analog 7 - CAN Speed Demand Switch</p>
Reset trip fuel counter*	<p>This command resets the trip fuel consumption counter. The command is activated through M-Logic (<i>Output, EIC commands, EIC Reset trip fuel</i>).</p>
Intermittent oil priming*	<p>Engage the pre-lubrication oil pump (if installed). The command is activated through M-Logic (<i>Output, EIC commands, EIC Intermittent oil priming</i>).</p>
Shutdown override	<p>See the J1939 command.</p>
Enable Cylinder Cutout*	<p>The command can be used to engage all cylinders if the engine is running with one bank only. The command is activated through M-Logic (<i>Output, EIC commands, EIC Enable Cylinder Cutout</i>).</p>
Speed increase*	<p>This command increases the speed of the engine by a small amount. The command is activated through M-Logic (<i>Output, EIC commands, EIC Speed Increase</i>).</p>
Speed decrease*	<p>This command decreases the speed of the engine by a small amount. The command is activated through M-Logic (<i>Output, EIC commands, EIC Speed Decrease</i>).</p>
Engine overspeed test*	<p>The command is activated through M-Logic (<i>Output, EIC commands, EIC Engine overspeed test</i>). The function is MTU-specific.</p>
Engine operating mode*	<p>Switches the operating mode of the engine. The command is activated through M-Logic (<i>Output, EIC commands, EIC Engine opr mode command</i>).</p>

Command	Description
Speed gov. param command*	Parameter switch for selection between: Default and Variant 1. M-Logic is used to select variant 1 parameters (<i>Output, EIC Commands, EIC Engine speed gov param command</i>). The function is MTU-specific.
Binary speed enable*	The ECU uses (or does not use) EIC binary speed for the speed bias. The command is activated through M-Logic (<i>Output, EIC commands, EIC binary Speed In-De Enable</i>). The function is MTU-specific.
Fast engine start*	The command is activated through M-Logic (<i>Output, EIC commands, MTU Fast Engine Start</i>). The function is MTU-specific.

NOTE * These are M-Logic commands. You can use Modbus virtual events to activate these commands. For more information, see [Using Modbus to activate M-Logic commands](#).

3.20.7 J1939 measurement

See the J1939 description for the measurements that the AGC supports. A value specific to MTU Smart Connect is listed below.

Text	PGN	S	L	P	SPN	Unit	J1939-71 scaling	Offset
EIC faults	65284	1	2	6	1218	-	1/bit	0

3.20.8 M-Logic events

The following additional events are available in M-Logic under *Events, EIC event* for MTU J1939 SmartConnect.

Event	Description
MTU LIMIT LAMP OFF (lamp)	Proprietary event.
MTU LIMIT LAMP ON (solid)	Proprietary event.
MTU LIMIT LAMP ON (blink)	Proprietary event.
MTU Limit Lamp ON Blink 2Hz (status)	Proprietary event.
MTU TIER4 Lamp ON Blink 2Hz (status)	Proprietary event.
MTU Buzzer Lamp OFF (status)	Proprietary event.
MTU Buzzer Lamp ON (solid)	Proprietary event.
MTU Buzzer Lamp ON Blink 1Hz (status)	Proprietary event.
MTU Buzzer Lamp ON Blink 2Hz (status)	Proprietary event (2 Hz is more severe than 1 Hz).

3.20.9 Modbus alarms

Alarms, status and measurement table (read only) function code 04h.

EIC alarms that activate alarms in the AGC

Addr.	Bit	Type	SPN	FMI
60	0	7570 ECU communication error		
60	1	7580 ECU warning		
60	2	7590 ECU shutdown		
60	3	7600 EC overspeed		
60	4	7610 ECU coolant water temp. 1		

Addr.	Bit	Type	SPN	FMI
60	5	7620 ECU coolant water temp. 2		
60	6	7630 ECU oil pressure level 1		
60	7	7640 ECU oil pressure level 2		
60	8	7650 ECU oil temp. 1		
60	9	7660 ECU oil temp. 2		
60	10	7670 ECU coolant level 1		
60	11	7680 ECU coolant level 2		
1020	0	7570 ECU communication error		
1021	0	SS T - Fuel	174	0
1021	1	SD T - Fuel	174	11
1021	14	ECU Yellow Lamp	188	
1021	15	ECU Red Lamp	190	
1022	0	SS T-Coolant	110	16
1022	1	SD T-Coolant	110	11
1022	2	AL L1 Level Coolant Water	111	17
1022	3	SD Level Coolant Water	111	11
1022	4	HI P-Fuel (Common Rail)	157	15
1022	5	LO P-Fuel (Common Rail)	157	17
1022	6	SD P-HD	157	11
1022	7	LO ECU Power Supply Voltage	158	17
1022	8	LOLO ECU Power Supply Voltage	158	1
1022	9	HI ECU Power Supply Voltage	158	15
1022	10	HIHI ECU Power Supply Voltage	158	0
1022	11	SD ECU Power Supply Voltage	158	11
1022	12	HI T - Intake Air	172	15
1022	13	HIHI T - Intake Air	172	0
1022	14	SD T - Intake Air	172	11
1022	15	HI T - Fuel	174	15
1023	0	HI P-Diff-Lube Oil	99	15
1023	1	SS P-Diff- Lube Oil	99	0
1023	2	SD P-Diff- Lube Oil	99	11
1023	3	LO P- Lube Oil	100	17
1023	4	SS P- Lube Oil	100	1
1023	5	SD P-Lube Oil	100	11
1023	6	HI P-Crankcase	101	15
1023	7	SS P-Crankcase	101	0
1023	8	SD P-Crankcase	101	11
1023	9	HI ETC1 Overspeed	103	15
1023	10	SS ETC1 Overspeed	103	0

Addr.	Bit	Type	SPN	FMI
1023	11	SD Charger Speed 1	103	11
1023	12	HI T-Charge Air	105	15
1023	13	SS T-Charge Air	105	0
1023	14	SD T-Charge Air	105	11
1023	15	HI T-Coolant	110	15
1024	0	EIC Communication Error (Warning)	-	-
1024	5	HI T-Coolant Intercooler	52	15
1024	6	SS T-Coolant Intercooler	52	0
1024	7	SD T-Coolant Intercooler	52	11
1024	8	LO P-Fuel	94	17
1024	9	SS P-Fuel	94	1
1024	10	SD P-Fuel before Filter	94	11
1024	11	HI P-Diff-Fuel	95	15
1024	12	SS P-Diff-Fuel	95	0
1024	13	SD P-Diff Fuel	95	11
1024	14	HI Level Water Fuel Prefilter	97	15
1024	15	SD Level Water Fuel Prefilter	97	11

EIC alarms are only Modbus bits

Addr.	Bit	Type	SPN	FMI
1064	0	HI T-Lube Oil	175	15
1064	1	SS T-Lube Oil	175	0
1064	2	SD T-Lube Oil	175	11
1064	3	SS Idle Speed not Reached	188	1
1064	4	SS Engine Overspeed	190	0
1064	5	SS Engine Speed too Low (only S2000, PR2.2500.027)	190	1
1064	6	SD Speed Demand	898	11
1064	7	HI T-ECU	1136	15
1064	8	SD T-ECU	1136	11
1064	9	AL Override applied	1237	31
1064	10	LO P-Fuel 2 (Common Rail)	1349	17
1064	11	HI P-Fuel 2 (Common Rail)	1349	15
1064	12	SD P-HD 2	1349	11
1064	13	SD-P-Fuel before Engine	1381	11
1064	14	AL L1 P-Fuel before Engine	1381	17
1064	15	SD P-Charge Air	3563	11
1065	0	LO Coolant Level Intercooler	3668	17
1065	1	SD Coolant Level Intercooler	3668	11
1065	2	SS T-Coolant L3	520923	0
1065	3	AL Power too high	520924	15

Addr.	Bit	Type	SPN	FMI
1065	4	LO U-PDU	520982	17
1065	5	LOLO U-PDU	520982	1
1065	6	HI U-PDU	520982	15
1065	7	HIHI U-PDU	520982	0
1065	8	SD U-PDU	520982	11
1065	9	SS Release Speed Not Reached	521002	1
1065	10	SS Starter Speed Not Reached	521003	1
1065	11	SS T-Preheat	521004	1
1065	12	LO T-Preheat	521004	17
1065	13	AL Stop Camshaft Sensor Defect	521016	31
1065	14	SD Crankshaft Speed	521017	11
1065	15	SD Camshaft Speed	521018	11
1066	0	AL Power Stage Low	521020	31
1066	1	AL Power Stage High	521021	31
1066	2	AL Stop Power Stage	521022	31
1066	3	AL Stop MV-Wiring Ground	521023	31
1066	4	SS Power Reduction Active	521026	31
1066	5	AL Stop SD	521027	31
1066	6	AL Ext. Engine Protection	521029	31
1066	7	AL Power Cut-Off detected	521031	31
1066	8	SD ETC1+ETC2	521038	11
1066	9	SD P-Fuel	521052	11

3.20.1 Modbus analogue values 0

Measurement table (read only) function code 01h

Addr.	Bit	Content	Unit	Scaling	PGN	SPN
52009		CAN Requested Engine Stop			65281	520568
52003		CAN Engine Start			65281	520569

Measurement table (read only) function code 04h

Addr.	Bit	Content	Unit	Scaling	PGN	SPN
593		Engine Speed	RPM	1/1		190
594		T-Coolant HT	°C/°F	1/1		110
595		P-Lube oil engine	bar/psi	1/10		100
597		T-Lube oil engine intake	°C/°F	1/1		175
598		T-Fuel LP	°C/°F	1/10		174
599		P-Charge-air	bar/psi	1/100		102
602		Engine Fuel Rate	l/h	1/10		183
604		T-Charge-air	°C/°F	1/1		105

Addr.	Bit	Content	Unit	Scaling	PGN	SPN
608		Engine Percent Load at current speed	%	1/1		92
611		Engine Total Hours of Operation	h	1/1		247
613		Power Supply ECU	V	1/10		158
627		bar/psiometric pressure	bar/psi	1/100		108
637		T-Coolant LT	°C/°F	1/1		52
638		Engine Trip Fuel	l	1/10		182
858		Fuel Consumption	g/kWh	1/1		520575
870	10	Engine Protection System has ShutdownEngine (general stop)	-		65252	1110
870	11	Engine Overspeed Test	-		65252	2812
870	12	Engine Alarm Acknowledge feedback	-		65252	2815
886		Engine Starter Mode	-		61444	1675
887		Actual Maximum Available Engine-Percent Torque	%		61443	3357
888		Engine Coolant Preheated State	-		65130	3553
889		Engine Safety and Protection Override Status	-		65360	520202
890		Engine Cylinder Cut-off	-		65360	520252
891		MTU Engine Running State	-		65360	520255
892		External Stop State	-		65360	520833
893		MTU Requested Absolute Torque	Nm		65360	520843
894		Source of Current Speed Demand	-		65361	520263
895		Engine Demanded Operating Speed (Speed Demand Effective)	RPM		65361	520707
896		Feedback of Speed Demand CAN	RPM		65361	520828
897		Feedback of Speed Demand Analogue Input	RPM		65361	520829
898		Speed Demand Fail Mode	-		65361	520830
900		Trip Average Fuel Rate	l/h	1/10		1029
901		Engine Rated Power	kW	1/1		166
904		Engine Total Fuel	l	1/10		250
939		Engine ECU Temperature	°C/°F	1/10		1136
940		Actual Droop	%	1/1		520831
978		Trip Engine Running Time	h	1/1		1036
1069		Engine Turning Gear Engaged	-		65281	1206
1070		Engine Shutdown Override Switch	-		65265	1237
1071		MTU Engine Controller Error Code	-	-		520256
1072		Requested Engine Control Mode	-		64915	4080
1073		Engine Overspeed Test	-		65281	520570

3.21 Perkins

3.21.1 Perkins ADEM3

ECU(s)	ADEM3		
Engine(s)			
Engine interface protocol (parameter 7561)	Perkins ADEM3		
EIC control			
Start	-		
Stop	-		
Speed control	●		
Default speed control source address	0		
J1939 message	TSC1, ETC1		
Idle mode	●		
50/60 Hz frequency selection	●		
Shutdown override	-		
Proprietary message(s)	Heartbeat		
Diagnostic messages			
DM1 Yellow lamp	●		
DM1 Red lamp	●		
DM1 Protect	●		
DM1 Malfunction	●		
DM2	●		
Emissions			
Tier 4/Stage V	-		
Force regeneration	-		
Inhibit regeneration	-		
Analogue readings*			
Engine speed	●	Inlet temperature	-
Percent load	●	Exhaust temperature	-
Oil pressure	●	Fuel pressure	●
Oil temperature	-	Fuel temperature	●
Coolant pressure	-	Water in fuel	-
Coolant temperature	●	Fuel consumption/rate (L/h)	●
Turbo pressure	●	Fuel used (L)	●
Atmospheric pressure	-	Battery voltage	●
Engine hours	●	Battery potential (voltage)	●

NOTE *External equipment can read all of these from the AGC Modbus server. Other EIC analogue readings may also be available.

General

DM1se: The secondary DM1 logs shows alarms from the EMCP 3.x genset controller.

EIC RelativeHumidity alarm (menu 15060): You can configure a relative humidity alarm (range -100 to 100 %, default is 50 %), with a delay of 0 to 100 s (default is 5 s).

Other: The AGC sends a "heartbeat" telegram using TSC1 global every half second. This prevents a communication warning from the ECU.

3.21.2 Perkins ADEM4

ECU(s)	ADEM4		
Engine(s)			
Engine interface protocol (parameter 7561)	Perkins ADEM4		
EIC control			
Start	-		
Stop	-		
Speed control	●		
Default speed control source address	0		
J1939 message	TSC1, ETC1		
Idle mode	●		
50/60 Hz frequency selection	●		
Shutdown override	-		
Proprietary message(s)	Heartbeat		
Diagnostic messages			
DM1 Yellow lamp	●		
DM1 Red lamp	●		
DM1 Protect	●		
DM1 Malfunction	●		
DM2	●		
Emissions			
Tier 4/Stage V	-		
Force regeneration	-		
Inhibit regeneration	-		
Analogue readings*			
Engine speed	●	Inlet temperature	-
Percent load	●	Exhaust temperature	-
Oil pressure	●	Fuel pressure	●
Oil temperature	-	Fuel temperature	●
Coolant pressure	-	Water in fuel	-
Coolant temperature	●	Fuel consumption/rate (L/h)	●
Turbo pressure	●	Fuel used (L)	●
Atmospheric pressure	-	Battery voltage	●
Engine hours	●	Battery potential (voltage)	●

NOTE *External equipment can read all of these from the AGC Modbus server. Other EIC analogue readings may also be available.

General

DM1se: The secondary DM1 logs shows alarms from the EMCP 3.x genset controller.

EIC RelativeHumidity alarm (menu 15060): You can configure a relative humidity alarm (range -100 to 100 %, default is 50 %), with a delay of 0 to 100 s (default is 5 s).

Other: The AGC sends a "heartbeat" telegram using TSC1 global every half second. This prevents a communication warning from the ECU.

3.21.3 Perkins Generic

ECU(s)	ADEM3, ADEM4		
Engine(s)	Series 850, 1100, 1200, 1300, 2300, 2500 and 2800		
Engine interface protocol (parameter 7561)	Perkins Generic		
EIC control			
Start	-		
Stop	-		
Speed control	●		
Default speed control source address	0		
J1939 message	TSC1, ETC1		
Idle mode	●		
50/60 Hz frequency selection	●		
Shutdown override	-		
Proprietary message(s)	Heartbeat		
Diagnostic messages			
DM1 Yellow lamp	●		
DM1 Red lamp	●		
DM1 Protect	●		
DM1 Malfunction	●		
DM2	●		
Emissions			
Tier 4/Stage V	-		
Force regeneration	-		
Inhibit regeneration	-		
Analogue readings*			
Engine speed	●	Inlet temperature	-
Percent load	●	Exhaust temperature	-
Oil pressure	●	Fuel pressure	●
Oil temperature	-	Fuel temperature	●
Coolant pressure	-	Water in fuel	-
Coolant temperature	●	Fuel consumption/rate (L/h)	●
Turbo pressure	●	Fuel used (L)	●
Atmospheric pressure	-	Battery voltage	●
Engine hours	●	Battery potential (voltage)	●

NOTE *External equipment can read all of these from the AGC Modbus server. Other EIC analogue readings may also be available.

General

DM1se: The secondary DM1 logs shows alarms from the EMCP 3.x genset controller.

EIC RelativeHumidity alarm (menu 15060): You can configure a relative humidity alarm (range -100 to 100 %, default is 50 %), with a delay of 0 to 100 s (default is 5 s).

Other: The AGC sends a "heartbeat" telegram using TSC1 global every half second. This prevents a communication warning from the ECU.

3.21.4 Perkins EDC17

ECU(s)	EDC17		
Engine(s)			
Engine interface protocol (parameter 7561)	Perkins EDC17C49		
EIC control			
Start	●		
Stop	●		
Speed control	●		
Default speed control source address	3		
J1939 message	TSC1, CM1, GC1		
Idle mode	●		
50/60 Hz frequency selection	●		
Shutdown override	-		
Diagnostic messages			
DM1 Yellow lamp	●		
DM1 Red lamp	●		
DM1 Protect	●		
DM1 Malfunction	●		
DM2	●		
Emissions			
Tier 4/Stage V	-		
Force regeneration	-		
Inhibit regeneration	-		
Analogue readings*			
Engine speed	●	Inlet temperature	●
Percent load	●	Exhaust temperature	●
Oil pressure	●	Fuel pressure	●
Oil temperature	●	Fuel temperature	●
Coolant pressure	●	Water in fuel	●
Coolant temperature	●	Fuel consumption/rate (L/h)	●
Turbo pressure	●	Fuel used (L)	●
Atmospheric pressure	●	Battery voltage	●
Engine hours	●	Battery potential (voltage)	●

NOTE *External equipment can read all of these from the AGC Modbus server. Other EIC analogue readings may also be available.

3.21.5 Perkins Series 400

ECU(s)	-		
Engine(s)	Series 400 Model IQ IR IW IY IF		
Engine interface protocol (parameter 7561)	Perkins StV 400		
EIC control			
Start	●		
Stop	●		
Speed control	●		
Default speed control source address	3		
J1939 message	TSC1, CM1, CM2, ESR, OHECS, EBC1, ENGSC		
Idle mode	●		
50/60 Hz frequency selection	●		
Shutdown override	-		
Proprietary message(s)			
Diagnostic messages			
DM1 Yellow lamp	●		
DM1 Red lamp	●		
DM1 Protect	●		
DM1 Malfunction	●		
DM2	●		
Emissions			
Tier 4/Stage V	●		
Force regeneration	●		
Inhibit regeneration	●		
Analogue readings*			
Engine speed	●	Inlet temperature	●
Percent load	●	Exhaust temperature	-
Oil pressure	●	Fuel pressure	-
Oil temperature	-	Fuel temperature	●
Coolant pressure	-	Water in fuel	●
Coolant temperature	●	Fuel consumption/rate (L/h)	●
Turbo pressure	●	Fuel used (L)	●
Atmospheric pressure	●	Battery voltage	●
Engine hours	●	Battery potential (voltage)	●

NOTE *External equipment can read all of these from the AGC Modbus server. Other EIC analogue readings may also be available.

General

DM1se: Secondary DM1 messages are received from the primary ECU.

3.21.6 Perkins Series 1200F

ECU(s)	-		
Engine(s)	Series 1200F Model MT, MU, MV, MW, BM and BN		
Engine interface protocol (parameter 7561)	Perkins StV 1200		
EIC control			
Start	●		
Stop	●		
Speed control	●		
Default speed control source address	3		
J1939 message	TSC1, CM1, CM2, ESR, OHECS, EBC1, ENGSC		
Idle mode	●		
50/60 Hz frequency selection	●		
Shutdown override	-		
Proprietary message(s)			
Diagnostic messages			
DM1 Yellow lamp	●		
DM1 Red lamp	●		
DM1 Protect	●		
DM1 Malfunction	●		
DM2	●		
Emissions			
Tier 4/Stage V	●		
Force regeneration	●		
Inhibit regeneration	●		
Analogue readings*			
Engine speed	●	Inlet temperature	●
Percent load	●	Exhaust temperature	-
Oil pressure	●	Fuel pressure	-
Oil temperature	-	Fuel temperature	●
Coolant pressure	-	Water in fuel	●
Coolant temperature	●	Fuel consumption/rate (L/h)	●
Turbo pressure	●	Fuel used (L)	●
Atmospheric pressure	●	Battery voltage	●
Engine hours	●	Battery potential (voltage)	●

NOTE *External equipment can read all of these from the AGC Modbus server. Other EIC analogue readings may also be available.

General

DM1se: Secondary DM1 messages are received from the primary ECU.

3.21.7 Perkins Series 400 and 1200

ECU(s)	-		
Engine(s)	Series 400 and 1200		
Engine interface protocol (parameter 7561)	Perkins Stage V		
EIC control			
Start	●		
Stop	●		
Speed control	●		
Default speed control source address	3		
J1939 message	TSC1, CM1, CM2, ESR, OHECS, EBC1, ENGSC		
Idle mode	●		
50/60 Hz frequency selection	●		
Shutdown override	-		
Proprietary message(s)			
Diagnostic messages			
DM1 Yellow lamp	●		
DM1 Red lamp	●		
DM1 Protect	●		
DM1 Malfunction	●		
DM2	●		
Emissions			
Tier 4/Stage V	●		
Force regeneration	●		
Inhibit regeneration	●		
Analogue readings*			
Engine speed	●	Inlet temperature	●
Percent load	●	Exhaust temperature	-
Oil pressure	●	Fuel pressure	-
Oil temperature	-	Fuel temperature	●
Coolant pressure	-	Water in fuel	●
Coolant temperature	●	Fuel consumption/rate (L/h)	●
Turbo pressure	●	Fuel used (L)	●
Atmospheric pressure	●	Battery voltage	●
Engine hours	●	Battery potential (voltage)	●

NOTE *External equipment can read all of these from the AGC Modbus server. Other EIC analogue readings may also be available.

General

DM1se: Secondary DM1 messages are received from the primary ECU.

3.21.8 Perkins Series 1200J

ECU(s)	-		
Engine(s)	Series 1200J Model SU, VM		
Engine interface protocol (parameter 7561)	Perkins StV 120xJ (SU/VM)		
EIC control			
Start	●		
Stop	●		
Speed control	●		
Default speed control source address	3		
J1939 message	TSC1, CM1, ESR, OHECS, EBC1, GC1		
Idle mode	●		
50/60 Hz frequency selection	●		
Shutdown override	-		
Proprietary message(s)			
Diagnostic messages			
DM1 Yellow lamp	●		
DM1 Red lamp	●		
DM1 Protect	●		
DM1 Malfunction	●		
DM2	●		
Emissions			
Tier 4/Stage V	●		
Force regeneration	●		
Inhibit regeneration	●		
Analogue readings*			
Engine speed	●	Inlet temperature	●
Percent load	●	Exhaust temperature	-
Oil pressure	●	Fuel pressure	-
Oil temperature	-	Fuel temperature	●
Coolant pressure	-	Water in fuel	●
Coolant temperature	●	Fuel consumption/rate (L/h)	●
Turbo pressure	●	Fuel used (L)	●
Atmospheric pressure	●	Battery voltage	●
Engine hours	●	Battery potential (voltage)	●

NOTE *External equipment can read all of these from the AGC Modbus server. Other EIC analogue readings may also be available.

3.21.9 Write commands

Use parameter 7563 (EIC Controls) to enable write commands.

Perkins write commands

Command	Description
Speed control	In general, this is the same as the J1939 command . J1939 TSC1 transmission rate is 20 ms.
EIC start/stop enable	See the J1939 command .

3.21.10 Safe signal for regeneration

For Perkins Series 400, to ensure safety, the following conditions must be met for the AGC to send the proprietary telegrams that allow regeneration:

- The genset breaker is open.
- The engine is running.
- The AGC is not in AUTO mode.
- Regeneration is not inhibited by M-Logic (that is, *Output*, *EIC commands*, *EIC DPF Regeneration Inhibit*).

3.21.11 Modbus alarms

The general EIC alarms for Perkins Series 400 that are activated in the AGC are in the **Modbus tables**. See *Input register* (function code 04), under Modbus address 1020.

Specific EIC alarms for Perkins Series 400

Addr.	Content	Bit	Type
1024	EIC alarms	0	EIC communication error
		1	EIC yellow
		2	EIC red
		3	EIC protection
		4	EIC malfunction
		5	Low oil pressure shutdown
		6	High intake manifold air temperature warning
		7	High intake manifold air temperature shutdown
		8	High intake manifold air temperature shutdown
		9	Water in fuel switch warning
		10	Water in fuel switch warning and derate
		11	Air filter restriction switch warning
		12	Air filter restriction switch warning and derate
		13	High engine coolant temperature warning
		14	High engine coolant temperature warning
15	High engine coolant temperature warning		

3.22 PSI/Power Solutions

ECU(s)			
Engine(s)	PSI/Power solutions		
Engine interface protocol (parameter 7561)	PSI/Power solutions		
EIC control			
Start	-		
Stop	-		
Speed control	●		
Default speed control source address	234		
J1939 message	TSC1, ACS		
Idle mode	●		
50/60 Hz frequency selection	●		
Shutdown override	-		
Proprietary message(s)			
Diagnostic messages			
DM1 Yellow lamp	●		
DM1 Red lamp	●		
DM1 Protect	●		
DM1 Malfunction	●		
DM2	●		
Emissions			
Tier 4/Stage V	●		
Force regeneration	-		
Inhibit regeneration	-		
Analogue readings*			
Engine speed	●	Inlet temperature	●
Percent load	●	Exhaust temperature	-
Oil pressure	●	Fuel pressure	●
Oil temperature	-	Fuel temperature	-
Coolant pressure	-	Water in fuel	-
Coolant temperature	●	Fuel consumption/rate (L/h)	●
Turbo pressure	●	Fuel used (L)	-
Atmospheric pressure	●	Battery voltage	●
Engine hours	●	Battery potential (voltage)	●

NOTE *External equipment can read all of these from the AGC Modbus server. Other EIC analogue readings may also be available.

NOTE See also *Displaying proprietary text for SPN/FMI combinations*.

3.22.1 Write commands

Use parameter 7563 (EIC Controls) to enable write commands.

PSI/Power Solutions write commands

Command	Description
Speed control	In general, this is the same as the J1939 command .
Idle speed	See the J1939 command .
Start/Stop	See the J1939 command .
EIC start/stop enable	See the J1939 command .
Shutdown override	See the J1939 command .
Breaker status	The AGC sends these SPNs to indicate the measured state of the generator circuit breakers: SPN 3645: Generator circuit breaker status SPN 3546: Utility circuit breaker status Bit state 000 = Open Bit state 001 = Closed Bit state 010 = Locked out Bit state 011-101 = Available for SAE assignment Bit state 110 = Error Bit state 111 = Not available

3.23 Scania

3.23.1 Scania EMS

ECU(s)	EMS		
Engine(s)	-		
Engine interface protocol (parameter 7561)	Scania EMS		
EIC control			
Start	●		
Stop	●		
Speed control	●		
Default speed control source address	39		
J1939 message	TSC1, CM1		
Idle mode	●		
50/60 Hz frequency selection	●		
Shutdown override	●		
Proprietary message(s)	DLN1, KWP2000		
Diagnostic messages			
DM1 Yellow lamp	●		
DM1 Red lamp	●		
DM1 Protect	●		
DM1 Malfunction	●		
DM2	-		
Emissions			
Tier 4/Stage V	-		
Force regeneration	-		
Inhibit regeneration	-		
Analogue readings*			
Engine speed	●	Inlet temperature	-
Percent load	●	Exhaust temperature	-
Oil pressure	●	Fuel pressure	-
Oil temperature	-	Fuel temperature	-
Coolant pressure	-	Water in fuel	-
Coolant temperature	●	Fuel consumption/rate (L/h)	●
Turbo pressure	●	Fuel used (L)	●
Atmospheric pressure	-	Battery voltage	●
Engine hours	●	Battery potential (voltage)	-

NOTE *External equipment can read all of these from the AGC Modbus server. Other EIC analogue readings may also be available.

3.23.2 Scania EMS S6

Scania EMS 2 S6 does not use the J1939 SPN/FMI (Suspect Parameter Number/Failure Mode Indicator) system for alarm handling. Instead the DLN2 system is used. For this reason, the alarm handling is also different.

ECU(s)	EMS S6 (KWP2000)		
Engine(s)	Dx9x, Dx12x, Dx16x		
Engine interface protocol (parameter 7561)	Scania EMS2 S6**		
EIC control			
Start	●		
Stop	●		
Speed control	●		
Default speed control source address	39		
J1939 message	TSC1, CM1		
Idle mode	●		
50/60 Hz frequency selection	●		
Shutdown override	●		
Proprietary message(s)	DLN1, KWP2000		
Diagnostic messages			
DM1 Yellow lamp	●		
DM1 Red lamp	●		
DM1 Protect	●		
DM1 Malfunction	●		
DM2	-		
Emissions			
Tier 4/Stage V	-		
Force regeneration	-		
Inhibit regeneration	-		
Analogue readings*			
Engine speed	●	Inlet temperature	-
Percent load	●	Exhaust temperature	-
Oil pressure	●	Fuel pressure	-
Oil temperature	-	Fuel temperature	-
Coolant pressure	-	Water in fuel	-
Coolant temperature	●	Fuel consumption/rate (L/h)	●
Turbo pressure	●	Fuel used (L)	●
Atmospheric pressure	-	Battery voltage	●
Engine hours	●	Battery potential (voltage)	-

NOTE *External equipment can read all of these from the AGC Modbus server. Other EIC analogue readings may also be available.

NOTE ** Previously called *Scania EMS2*.

3.23.3 Scania EMS2 S8

Scania EMS 2 S8 does not use the J1939 SPN/FMI (Suspect Parameter Number/Failure Mode Indicator) system for alarm handling. Instead the DLN2 system is used. For this reason, the alarm handling is also different.

ECU(s)	Scania EMS2 S8		
Engine(s)	DC9, DC13, DC16		
Engine interface protocol (parameter 7561)	Scania EMS2 S8		
EIC control			
Start	●		
Stop	●		
Speed control	●		
Default speed control source address	39		
J1939 message	TSC1, CM1		
Idle mode	●		
50/60 Hz frequency selection	●		
Shutdown override	●		
Proprietary message(s)	ADC, DLN1, DLN2, DLN7 and DLN8		
Diagnostic messages			
DM1 Yellow lamp	●		
DM1 Red lamp	●		
DM1 Protect	●		
DM1 Malfunction	●		
DM2	-		
Emissions			
Tier 4/Stage V	●		
Force regeneration	●		
Inhibit regeneration	●		
Analogue readings*			
Engine speed	●	Inlet temperature	-
Percent load	●	Exhaust temperature	-
Oil pressure	●	Fuel pressure	-
Oil temperature	-	Fuel temperature	-
Coolant pressure	-	Water in fuel	-
Coolant temperature	●	Fuel consumption/rate (L/h)	●
Turbo pressure	●	Fuel used (L)	●
Atmospheric pressure	-	Battery voltage	●
Engine hours	●	Battery potential (voltage)	-

NOTE *External equipment can read all of these from the AGC Modbus server. Other EIC analogue readings may also be available.

NOTE The normal shutdown from the ECU activates the AGC alarm *EIC warning* (menu 7580).

3.23.4 Scania S8 Industrial

ECU(s)	Scania EMS2 S8		
Engine(s)	DC9, DC13, DC16		
Engine interface protocol (parameter 7561)	Scania S8 Industrial		
EIC control			
Start	●		
Stop	●		
Speed control	●		
Default speed control source address	39		
J1939 message	TSC1, CM1		
Idle mode	●		
50/60 Hz frequency selection	●		
Shutdown override	●		
Proprietary message(s)	DLN1, ADC		
Diagnostic messages			
DM1 Yellow lamp	●		
DM1 Red lamp	●		
DM1 Protect	●		
DM1 Malfunction	●		
DM2			
Emissions			
Tier 4/Stage V	●		
Force regeneration	●		
Inhibit regeneration	●		
Analogue readings*			
Engine speed	●	Inlet temperature	-
Percent load	●	Exhaust temperature	-
Oil pressure	●	Fuel pressure	-
Oil temperature	-	Fuel temperature	-
Coolant pressure	-	Water in fuel	-
Coolant temperature	●	Fuel consumption/rate (L/h)	●
Turbo pressure	●	Fuel used (L)	●
Atmospheric pressure	-	Battery voltage	●
Engine hours	●	Battery potential (voltage)	-

NOTE *External equipment can read all of these from the AGC Modbus server. Other EIC analogue readings may also be available.

3.23.5 Displaying alarms

For EMS S6, press the LOG button for 2 seconds. The display shows the alarm log. The top line shows the AC values, and is not used by the alarm list.

```

BB   0   0   0V
1105 Speed sensor 1
Active alarms: 6
CLRALL      First Last

```

Example:

The Scania KWP2000 log shows a mix of active and passive alarms.

Use the  and  buttons to scroll through the list.

CLRALL: Press ENTER to clear the entire alarm log list. For safety reasons, this requires the master password.

3.23.6 Error log

You can to retrieve and acknowledge alarms in the error log of the Scania EMS S6 (KWP2000).

The alarms available are the same alarms which can be read by the flash combination of the diagnostics lamp on the EMS S6 (refer to the engine documentation).

NOTE The EMS S6 software version and engine number is automatically retrieved when CAN bus communication is established.

Flash code	Display text	Description
11	Overrevving	One or both engine speed sensors have indicated above 3000 RPM
12	Speed sensor 1	Engine sensor 1
13	Speed sensor 2	Engine sensor 2
14	Water T sen.	Engine coolant temperature sensor
15	Char. air T sen	Charge air temperature sensor
16	Char. air P sen	Charge air pressure sensor
17	Oil temp. sen.	Oil temperature sensor
18	Oil pres. sen.	Oil pressure sensor
23	Fault in cor.	Fault in coordinator
25	Throttle pedal	CAN message for fine tune nominal speed out of range
27	Emerg. stop o.r	Engine stop overridden
31	Oil pres. prot	Oil pressure protection activated
32	Wrong parameter	Wrong parameter setting for defect CAN communication
33	Battery voltage	Battery voltage out of range
37	Emerg. stop cor	Emergency stop switch activated
43	CAN cir. defect	CAN circuit defect
48	CAN mess. DLN1	CAN message from the coordinator missing or not correct
49	Wrong CAN ver.	Non-matching CAN version in EMS and coordinator
51	Un. inj. cyl. 1	Unit injector cylinder 1
52	Un. inj. cyl. 2	Unit injector cylinder 2
53	Un. inj. cyl. 3	Unit injector cylinder 3
54	Un. inj. cyl. 4	Unit injector cylinder 4

Flash code	Display text	Description
55	Un. inj. cyl. 5	Unit injector cylinder 5
56	Un. inj. cyl. 6	Unit injector cylinder 6
57	Un. inj. cyl. 7	Unit injector cylinder 7
58	Un. inj. cyl. 8	Unit injector cylinder 8
59	Extra ana. inp.	Voltage out of range on extra analogue input pin
61	System shutdown	System shut down incorrectly
66	Coola. l. prot.	Low engine coolant level
86	HW watchdog	Hardware watchdog
87	Fault in RAM	The EMS has detected that the fault code memory is not functioning correctly
89	Seal	The programme in the EMS has been altered in a prohibited manner
94	Coola. shut off	Engine coolant temperature/oil pressure shutdown
96	Overheat prot.	Overheat protection activated
99	Fault in TPU	Error in TPU Timer Processor Unit

3.23.7 Warnings and shutdowns (DLN2 alarms)

For EMS 2 S8, this is a list of warnings and shutdowns that can be shown on the display. Each alarm will be shown as an alarm in the alarm window. The alarms can be acknowledged from the display, but they will be visible until the alarm disappears in the ECU.

Handling of alarms is only active when the engine is running.

Warning/shutdown	DLN2 warning	DLN2 shutdown
EMS warning	●	-
Low oil pressure	●	-
High coolant temp	●	-
Stop limit exceeded	-	●
Charge 61	●	-
EIC yellow lamp	●	-
EIC red lamp	-	●
EIC malfunction	●	-
EIC protection	●	-

NOTE If DLN2 is "-" the alarm is not supported.

3.23.8 Write commands for Scania EMS

The AGC can only write commands to the engine if the Scania Coordinator is NOT mounted.

Use parameter 7563 (EIC Controls) to enable write commands.

Scania EMS write commands

Command	Description
Speed control	In general, this is the same as the J1939 command . However, the CAN bus ID for speed control is 0xCFF8027, and the CAN bus ID for the offset is 0xCFFF727. J1939 TSC1.
Idle speed	See the J1939 command .
Start/Stop	See the J1939 command .
Shutdown override	See the J1939 command .
Droop	Use M-Logic to enable sending a droop set point: <i>Output, EIC commands, EIC Droop</i> . When <i>EIC Droop</i> is activated, the AGC sends the droop setting in parameter 2771 as the set point for the ECU droop.
Frequency selection	You can select the nominal speed in parameter 2772 (Scania rpm). The options are: <ul style="list-style-type: none">• User• 1500RPM• 1800RPM• Low idle If User is selected, the AGC bases the nominal speed on the nominal frequency.

NOTE The AGC can send all the above commands to the Scania EMS. The EMS does not necessarily support all of the above commands.

3.23.9 Write commands for Scania EMS 2

The AGC can only write commands to the engine if the Scania Coordinator is NOT mounted.

Use parameter 7563 (EIC Controls) to enable write commands.

Scania EMS 2 write commands

Command	Description
Speed control	In general, this is the same as the J1939 command . However, the CAN bus ID for speed control is 0xCFF8027, and the CAN bus ID for the offset is 0xCFFF727. J1939 TSC1.
Idle speed	See the J1939 command .
Start/Stop	See the J1939 command .
Shutdown override	See the J1939 command .
Droop	Use M-Logic to enable sending a droop set point: <i>Output, EIC commands, EIC Droop</i> . When <i>EIC Droop</i> is activated, the AGC sends the droop setting in parameter 2771 as the set point for the ECU droop.
Frequency selection	You can select the nominal speed in parameter 2772 (Scania rpm). The options are: <ul style="list-style-type: none">• User• 1500RPM• 1800RPM• Low idle If User is selected, the AGC bases the nominal speed on the nominal frequency.

3.23.1 Safe signal for regeneration 0

For EMS S8, to ensure safety, the following conditions must be met for the AGC to send the proprietary telegrams that allow regeneration:

- The genset breaker is open.

- The engine is running.
- The AGC is not in AUTO mode.
- Regeneration is not inhibited by M-Logic (that is, *Output, EIC commands, EIC DPF Regeneration Inhibit*).

3.23.11 M-Logic (Scania EMS2 S8)

Events

The following additional events are available in M-Logic under *Events, EIC event* for Scania EMS2 S8.

Event	Description
Scania S8 - Evaporation not required	Proprietary event.
Scania S8 - Evaporation required - less urgent	Proprietary event.
Scania S8 - Evaporation required - urgent	Proprietary event.
Scania S8 - Evaporation is in progress	Proprietary event.

Command

The following additional command is available in M-Logic under *Output, EIC commands* for Scania EMS2 S8.

Command	Description
Scania EMS2 S8 Activate Safe regeneration signal	Proprietary command. Sends a signal to the ECU to activate a heat break in the exhaust system.

3.23.12 Modbus alarms

Alarm, status and measurement table (read-only) function code 04h.

EIC alarms

Addr.	Bit	Type
1026	0	EIC overrevving
	1	EIC speed sensor 1
	2	EIC speed sensor 2
	3	EIC water temp. sensor
	4	EIC charge air temp. sensor
	5	EIC charge air pressure sensor
	6	EIC oil temp. sensor
	7	EIC oil pressure sensor
	8	EIC fault in cor.
	9	EIC throttle pedal
	10	EIC emergency stop override
	11	EIC oil pressure prot.
	12	EIC wrong parameter
	13	EIC battery voltage
	14	EIC oil pressure prot.
15	EIC emergency stop cor.	

Addr.	Bit	Type
1027	0	EIC CAN cir. defect
	1	EIC CAN mess. DLN1
	2	EIC Wrong CAN version
	3	EIC un. inj. cyl. 1
	4	EIC un. inj. cyl. 2
	5	EIC un. inj. cyl. 3
	6	EIC un. inj. cyl. 4
	7	EIC un. inj. cyl. 5
	8	EIC un. inj. cyl. 6
	9	EIC un. inj. cyl. 7
	10	EIC un. inj. cyl. 8
	11	EIC extra ana. inp.
	12	EIC system shutdown
	13	EIC coola. L. prot.
	14	EIC HW watchdog
15	EIC fault in RAM	
1028	0	EIC seal
	1	EIC coola. shut OFF
	2	EIC overheat prot.
	3	Fault in TPU
	4	Not used
	5	Not used
	6	Not used
	7	Not used
	8	Not used
	9	Not used
	10	Not used
	11	Not used
	12	Not used
	13	Not used
	14	Not used
15	Not used	

3.24 Steyr

3.24.1 Steyr EDC

ECU(s)	EDC17		
Engine(s)			
Engine interface protocol (parameter 7561)	Steyr EDC17		
EIC control			
Start	●		
Stop	●		
Speed control	●		
Default speed control source address	3		
J1939 message	TSC1, CM1, GC1		
Idle mode	●		
50/60 Hz frequency selection	●		
Shutdown override	-		
Diagnostic messages			
DM1 Yellow lamp	●		
DM1 Red lamp	●		
DM1 Protect	●		
DM1 Malfunction	●		
DM2	●		
Emissions			
Tier 4/Stage V	-		
Force regeneration	-		
Inhibit regeneration	-		
Analogue readings*			
Engine speed	●	Inlet temperature	●
Percent load	●	Exhaust temperature	●
Oil pressure	●	Fuel pressure	●
Oil temperature	●	Fuel temperature	●
Coolant pressure	●	Water in fuel	●
Coolant temperature	●	Fuel consumption/rate (L/h)	●
Turbo pressure	●	Fuel used (L)	●
Atmospheric pressure	●	Battery voltage	●
Engine hours	●	Battery potential (voltage)	●

NOTE *External equipment can read all of these from the AGC Modbus server. Other EIC analogue readings may also be available.

3.25 Volvo Penta

3.25.1 Volvo Penta Generic EDC

ECU(s)	EDC III, EDC IV		
Engine(s)	TAD4x, TAD5x, TAD6x, TAD7x		
Engine interface protocol (parameter 7561)	Volvo Penta Generic		
EIC control			
Start	-		
Stop	-		
Speed control	●		
Default speed control source address	3		
J1939 message	TSC1		
Idle mode	●		
50/60 Hz frequency selection	●		
Shutdown override	●		
Proprietary message(s)			
Diagnostic messages			
DM1 Yellow lamp	●		
DM1 Red lamp	●		
DM1 Protect	●		
DM1 Malfunction	●		
DM2	●		
Emissions			
Tier 4/Stage V	-		
Force regeneration	-		
Inhibit regeneration	-		
Analogue readings*			
Engine speed	●	Inlet temperature	-
Percent load	●	Exhaust temperature	-
Oil pressure	●	Fuel pressure	-
Oil temperature	-	Fuel temperature	●
Coolant pressure	-	Water in fuel	-
Coolant temperature	●	Fuel consumption/rate (L/h)	●
Turbo pressure	●	Fuel used (L)	-
Atmospheric pressure	●	Battery voltage	●
Engine hours	●	Battery potential (voltage)	-

NOTE *External equipment can read all of these from the AGC Modbus server. Other EIC analogue readings may also be available.

3.25.2 Volvo Penta EDC3

ECU(s)	EDC3		
Engine(s)			
Engine interface protocol (parameter 7561)	Volvo Penta EDC3		
EIC control			
Start	-		
Stop	-		
Speed control	●		
Default speed control source address	3		
J1939 message	TSC1		
Idle mode	●		
50/60 Hz frequency selection	●		
Shutdown override	●		
Proprietary message(s)			
Diagnostic messages			
DM1 Yellow lamp	●		
DM1 Red lamp	●		
DM1 Protect	●		
DM1 Malfunction	●		
DM2	●		
Emissions			
Tier 4/Stage V	-		
Force regeneration	-		
Inhibit regeneration	-		
Analogue readings*			
Engine speed	●	Inlet temperature	-
Percent load	●	Exhaust temperature	-
Oil pressure	●	Fuel pressure	-
Oil temperature	-	Fuel temperature	●
Coolant pressure	-	Water in fuel	-
Coolant temperature	●	Fuel consumption/rate (L/h)	●
Turbo pressure	●	Fuel used (L)	-
Atmospheric pressure	●	Battery voltage	●
Engine hours	●	Battery potential (voltage)	-

NOTE *External equipment can read all of these from the AGC Modbus server. Other EIC analogue readings may also be available.

3.25.3 Volvo Penta EDC4

ECU(s)	EDC4		
Engine(s)			
Engine interface protocol (parameter 7561)	Volvo Penta EDC4		
EIC control			
Start	-		
Stop	-		
Speed control	●		
Default speed control source address	3		
J1939 message	TSC1		
Idle mode	●		
50/60 Hz frequency selection	●		
Shutdown override	●		
Proprietary message(s)			
Diagnostic messages			
DM1 Yellow lamp	●		
DM1 Red lamp	●		
DM1 Protect	●		
DM1 Malfunction	●		
DM2	●		
Emissions			
Tier 4/Stage V	-		
Force regeneration	-		
Inhibit regeneration	-		
Analogue readings*			
Engine speed	●	Inlet temperature	-
Percent load	●	Exhaust temperature	-
Oil pressure	●	Fuel pressure	-
Oil temperature	-	Fuel temperature	●
Coolant pressure	-	Water in fuel	-
Coolant temperature	●	Fuel consumption/rate (L/h)	●
Turbo pressure	●	Fuel used (L)	-
Atmospheric pressure	●	Battery voltage	●
Engine hours	●	Battery potential (voltage)	-

NOTE *External equipment can read all of these from the AGC Modbus server. Other EIC analogue readings may also be available.

3.25.4 Volvo Penta Generic EMS

ECU(s)	EMS, EMS 2.0 to EMS2.3		
Engine(s)	D6, D7, D9, D12, D16 (GE and AUX variants only)		
Engine interface protocol (parameter 7561)	Volvo Penta EMS2		
EIC control			
Start	●		
Stop	●		
Speed control	●		
Default speed control source address	3		
J1939 message	TSC1		
Idle mode	●		
50/60 Hz frequency selection	●		
Shutdown override	●		
Proprietary message(s)	VP70		
Diagnostic messages			
DM1 Yellow lamp	●		
DM1 Red lamp	●		
DM1 Protect	●		
DM1 Malfunction	●		
DM2	-		
Emissions			
Tier 4/Stage V	ECU v 2.3 or later		
Force regeneration	-		
Inhibit regeneration	-		
Analogue readings*			
Engine speed	●	Inlet temperature	-
Percent load	●	Exhaust temperature	●
Oil pressure	●	Fuel pressure	●
Oil temperature	●	Fuel temperature	-
Coolant pressure	●	Water in fuel	-
Coolant temperature	●	Fuel consumption/rate (L/h)	●
Turbo pressure	●	Fuel used (L)	●
Atmospheric pressure	-	Battery voltage	●
Engine hours	●	Battery potential (voltage)	-

NOTE *External equipment can read all of these from the AGC Modbus server. Other EIC analogue readings may also be available.

3.25.5 Volvo Penta EMS2.3

ECU(s)	EMS2.3		
Engine(s)			
Engine interface protocol (parameter 7561)	Volvo Penta EMS2.3		
EIC control			
Start	●		
Stop	●		
Speed control	●		
Default speed control source address	3		
J1939 message	TSC1		
Idle mode	●		
50/60 Hz frequency selection	●		
Shutdown override	●		
Proprietary message(s)	VP70		
Diagnostic messages			
DM1 Yellow lamp	●		
DM1 Red lamp	●		
DM1 Protect	●		
DM1 Malfunction	●		
DM2	-		
Emissions			
Tier 4/Stage V	●		
Force regeneration	-		
Inhibit regeneration	-		
Analogue readings*			
Engine speed	●	Inlet temperature	-
Percent load	●	Exhaust temperature	●
Oil pressure	●	Fuel pressure	●
Oil temperature	●	Fuel temperature	-
Coolant pressure	●	Water in fuel	-
Coolant temperature	●	Fuel consumption/rate (L/h)	●
Turbo pressure	●	Fuel used (L)	●
Atmospheric pressure	-	Battery voltage	●
Engine hours	●	Battery potential (voltage)	-

NOTE *External equipment can read all of these from the AGC Modbus server. Other EIC analogue readings may also be available.

NOTE See also *Displaying proprietary text for SPN/FMI combinations*.

3.25.6 Volvo Penta EMS 2.4

ECU(s)	EMS2.4		
Engine(s)	-		
Engine interface protocol (parameter 7561)	Volvo Penta EMS 2.4		
EIC control			
Start	●		
Stop	●		
Speed control	●		
Default speed control source address	3		
J1939 message	TSC1, CM1		
Idle mode	●		
50/60 Hz frequency selection	●		
Shutdown override	●		
Proprietary message(s)	VP70		
Diagnostic messages			
DM1 Yellow lamp	●		
DM1 Red lamp	●		
DM1 Protect	●		
DM1 Malfunction	●		
DM2	-		
Emissions			
Tier 4/Stage V	●		
Force regeneration	●		
Inhibit regeneration	●		
Analogue readings*			
Engine speed	●	Inlet temperature	-
Percent load	●	Exhaust temperature	●
Oil pressure	●	Fuel pressure	●
Oil temperature	●	Fuel temperature	-
Coolant pressure	-	Water in fuel	-
Coolant temperature	●	Fuel consumption/rate (L/h)	●
Turbo pressure	●	Fuel used (L)	●
Atmospheric pressure	-	Battery voltage	●
Engine hours	●	Battery potential (voltage)	-

NOTE *External equipment can read all of these from the AGC Modbus server. Other EIC analogue readings may also be available.

NOTE See also *Displaying proprietary text for SPN/FMI combinations*.

3.25.7 Warnings and shutdowns

Warning and shutdown list	J1939 codes		
	SPN	FMI warning	FMI shutdown
Low oil pressure	100	5	-
Intake manifold #1 P	102	-	-
Coolant temperature	110	5	-
High inlet air temp.	172	5	-
Fuel temperature	174	-	-
Fuel pressure	94	5	-
Oil level	98	5	-
Overspeed	190	-	0
Coolant level low	111	-	1

NOTE If FMI is "-" the alarm is not supported.

3.25.8 Second ECU

A second ECU can be connected for Volvo Penta EMS2.3 and EMS2.4. The second ECU is an add-on and used for the aftertreatment system.

3.25.9 Volvo speed control

Use *Volvo speed control* (parameter 15110) to activate proprietary engine control. The default is *Standard J1939* (TSC1 (standard J1939) is used).

For a Volvo ECU, select either *Volvo proprietary - Primary speed 50 Hz* or *Volvo proprietary - Primary speed 60 Hz*, depending on the primary speed of the Volvo engine. The primary speed is the speed configured for the engine at the factory. If either option is used, the AGC disables standard J1939 speed control and uses the Volvo proprietary VP70 instead.

To change the frequency when parameter 15110 is set to *Volvo proprietary - Primary speed 50 Hz* or *Volvo proprietary - Primary speed 60 Hz*:

1. Power down the Volvo ECU/EMS.
2. Change the selection in the AGC.
3. Power up the Volvo ECU/EMS.
4. After powering up the ECU/EMS, change the selection in parameter 15110 within 10 seconds. This ensures that the CAN signal is triggered within 10 seconds of ignition on, to allow detection of the signal edge.
5. Power down the Volvo ECU/EMS.
6. Power up the Volvo ECU/EMS.
7. Start the engine.

The selection is now changed.

3.25.1 Tier 4 aftertreatment support

For a general description, see [Tier 4/Stage V](#). Tier 4 is supported if the ECU is version 2.3 or later.

3.25.11 Emergency Inducement Override

For EMS 2.4, the AGC can read VP282, a telegram with emergency inducement override information. The AGC can show the information on a display and on Modbus. For more information, see the *Input register (04)*, Modbus addresses 1087, 1088 and 1089 in the **Modbus tables**.

3.25.12M-Logic events

The following additional events are available in M-Logic under *Events, EIC event*.

Event	Description
Purge Active ON (status)	Proprietary event.
Inducement not active (status)	Proprietary event.
Inducements warning (status)	Proprietary event.
Derate active (status)	Proprietary event.
Pre severe derate warning (status)	Proprietary event.
Severe derate (status)	Proprietary event.
Temporate override of derate (status)	Proprietary event.
Scr Inducement Reason OK (status)	Proprietary event.
Reagent tank low (status)	Proprietary event.
Incorrect reagent quality (status)	Proprietary event.
Absence of reagent dosing (status)	Proprietary event.

3.25.13Write commands

Use parameter 7563 (EIC Controls) to enable write commands.

Volvo Penta write commands

Command	Description
Speed control	In general, this is the same as the J1939 command . However, the CAN bus ID for speed control is 0xCFF4611 (Volvo Penta proprietary telegram).
Idle speed	See the J1939 command .
Preheat	Before an engine start, the AGC sends a preheat signal. The ECU determines whether preheating is needed. When the preheat is completed, the AGC can start the engine.
Start/Stop	See the J1939 command .
Shutdown override	See the J1939 command .
Frequency selection (50 or 60 Hz)	In general, see the J1939 command . In addition, the AGC meets the proprietary requirements for this command.

3.25.1 Modbus alarms

4

Alarm, status and measurement table (read-only) function code 04h.

Addr.	Content	Bit	Type
1020	EIC alarms, DEIF controller	0	7570 EIC communication error
		1	7580 EIC warning
		2	7590 EIC shutdown
		3	7600 EIC overspeed
		4	7610 EIC coolant water temperature 1
		5	7620 EIC coolant water temperature 2
		6	7630 EIC oil pressure 1
		7	7640 EIC oil pressure 2
		8	7650 EIC oil temp. 1
		9	7660 EIC oil temp. 2
		10	7670 EIC coolant level 1
		11	7680 EIC coolant level 2
1024	EIC alarms (DM 1)	0	EIC overspeed, warning
		1	EIC oil pressure, warning
		2	EIC oil temperature, warning
		3	EIC high coolant temperature, warning
		4	EIC low coolant level, warning
		5	EIC fuel pressure, warning
		6	EIC ECU yellow lamp, warning
		7	EIC ECU red lamp, shutdown
		8	EIC high inlet air temperature, warning
		10	EIC battery voltage, warning
		11	EIC low oil level, warning
		12	EIC protection
		13	EIC malfunction

3.26 Weichai

3.26.1 Weichai Diesel

ECU(s)	WOODWARD PG+		
Engine(s)	Diesel		
Engine interface protocol (parameter 7561)	Weichai Diesel		
EIC control			
Start	-		
Stop	-		
Speed control	●		
Default speed control source address	3		
J1939 message	TSC1		
Idle mode	●		
50/60 Hz frequency selection	●		
Shutdown override	-		
Proprietary message(s)	-		
Diagnostic messages			
DM1 Yellow lamp	●		
DM1 Red lamp	●		
DM1 Protect	●		
DM1 Malfunction	●		
DM2	●		
Emissions			
Tier 4/Stage V	●		
Force regeneration	-		
Inhibit regeneration	-		
Analogue readings*			
Engine speed	●	Inlet temperature	-
Percent load	-	Exhaust temperature	-
Oil pressure	●	Fuel pressure	-
Oil temperature	●	Fuel temperature	●
Coolant pressure	-	Water in fuel	-
Coolant temperature	●	Fuel consumption/rate (L/h)	●
Turbo pressure	●	Fuel used (L)	●
Atmospheric pressure	-	Battery voltage	-
Engine hours	-	Battery potential (voltage)	-

NOTE *External equipment can read all of these from the AGC Modbus server. Other EIC analogue readings may also be available.

3.26.2 Weichai Gas

ECU(s)	WOODWARD PG+		
Engine(s)	Gas		
Engine interface protocol (parameter 7561)	Weichai Gas		
EIC control			
Start	-		
Stop	-		
Speed control	●		
Default speed control source address	3		
J1939 message	TSC1		
Idle mode	●		
50/60 Hz frequency selection	●		
Shutdown override	-		
Proprietary message(s)	-		
Diagnostic messages			
DM1 Yellow lamp	●		
DM1 Red lamp	●		
DM1 Protect	●		
DM1 Malfunction	●		
DM2	●		
Emissions			
Tier 4/Stage V	●		
Force regeneration	-		
Inhibit regeneration	-		
Analogue readings*			
Engine speed	●	Inlet temperature	-
Percent load	-	Exhaust temperature	-
Oil pressure	●	Fuel pressure	-
Oil temperature	●	Fuel temperature	●
Coolant pressure	-	Water in fuel	-
Coolant temperature	●	Fuel consumption/rate (L/h)	●
Turbo pressure	●	Fuel used (L)	●
Atmospheric pressure	-	Battery voltage	-
Engine hours	-	Battery potential (voltage)	-

NOTE *External equipment can read all of these from the AGC Modbus server. Other EIC analogue readings may also be available.

3.26.3 Weichai Wise 10B

ECU(s)	Wise 10B		
Engine(s)	Diesel		
Engine interface protocol (parameter 7561)	Weichai Wise10B		
EIC control			
Start	-		
Stop	-		
Speed control	●		
Default speed control source address	3		
J1939 message	TSC1		
Idle mode	●		
50/60 Hz frequency selection	●		
Shutdown override	-		
Proprietary message(s)	-		
Diagnostic messages			
DM1 Yellow lamp	●		
DM1 Red lamp	●		
DM1 Protect	●		
DM1 Malfunction	●		
DM2	●		
Emissions			
Tier 4/Stage V	●		
Force regeneration	-		
Inhibit regeneration	-		
Analogue readings*			
Engine speed	●	Inlet temperature	-
Percent load	-	Exhaust temperature	-
Oil pressure	●	Fuel pressure	-
Oil temperature	●	Fuel temperature	●
Coolant pressure	-	Water in fuel	-
Coolant temperature	●	Fuel consumption/rate (L/h)	●
Turbo pressure	●	Fuel used (L)	●
Atmospheric pressure	-	Battery voltage	-
Engine hours	-	Battery potential (voltage)	-

NOTE *External equipment can read all of these from the AGC Modbus server. Other EIC analogue readings may also be available.

3.26.4 Weichai Wise 15

ECU(s)	Wise 15		
Engine(s)	Diesel		
Engine interface protocol (parameter 7561)	Weichai Wise15		
EIC control			
Start	-		
Stop	-		
Speed control	●		
Default speed control source address	3		
J1939 message	TSC1		
Idle mode	●		
50/60 Hz frequency selection	●		
Shutdown override	-		
Proprietary message(s)	-		
Diagnostic messages			
DM1 Yellow lamp	●		
DM1 Red lamp	●		
DM1 Protect	●		
DM1 Malfunction	●		
DM2	●		
Emissions			
Tier 4/Stage V	●		
Force regeneration	-		
Inhibit regeneration	-		
Analogue readings*			
Engine speed	●	Inlet temperature	-
Percent load	-	Exhaust temperature	-
Oil pressure	●	Fuel pressure	-
Oil temperature	●	Fuel temperature	●
Coolant pressure	-	Water in fuel	-
Coolant temperature	●	Fuel consumption/rate (L/h)	●
Turbo pressure	●	Fuel used (L)	●
Atmospheric pressure	-	Battery voltage	-
Engine hours	-	Battery potential (voltage)	-

NOTE *External equipment can read all of these from the AGC Modbus server. Other EIC analogue readings may also be available.

3.26.5 Weichai Baudouin E6 Gas

ECU(s)	Weichai Baudouin E6 Gas		
Engine(s)			
Engine interface protocol (parameter 7561)	Weichai Baudouin E6 Gas		
EIC control			
Start	-		
Stop	-		
Speed control	●		
Default speed control source address	EA		
J1939 message	TSC1, GC2, EBC1, ACS, GTACP		
Idle mode	●		
50/60 Hz frequency selection	●		
Shutdown override	-		
Proprietary message(s)	-		
Diagnostic messages			
DM1 Yellow lamp	●		
DM1 Red lamp	●		
DM1 Protect	●		
DM1 Malfunction	●		
DM2	●		
Emissions			
Tier 4/Stage V	-		
Force regeneration	-		
Inhibit regeneration	-		
Analogue readings*			
Engine speed	●	Inlet temperature	-
Percent load	-	Exhaust temperature	-
Oil pressure	-	Fuel pressure	-
Oil temperature	●	Fuel temperature	●
Coolant pressure	●	Water in fuel	-
Coolant temperature	●	Fuel consumption/rate (L/h)	-
Turbo pressure	-	Fuel used (L)	-
Atmospheric pressure	●	Battery voltage	-
Engine hours	-	Battery potential (voltage)	-

NOTE *External equipment can read all of these from the AGC Modbus server. Other EIC analogue readings may also be available.

3.27 Xichai

3.27.1 Xichai Gas

ECU(s)		
Engine(s)		
Engine interface protocol (parameter 7561)		Xichai Gas
EIC control		
Start	●	
Stop	●	
Speed control	●	
Default speed control source address		3
J1939 message		TSC1, CM1, GC1
Idle mode	●	
50/60 Hz frequency selection	●	
Shutdown override		-
Diagnostic messages		
DM1 Yellow lamp	●	
DM1 Red lamp	●	
DM1 Protect	●	
DM1 Malfunction	●	
DM2	●	
Emissions		
Tier 4/Stage V	●	
Force regeneration	●	
Inhibit regeneration	●	
Analogue readings*		
Engine speed	●	Inlet temperature ●
Percent load	●	Exhaust temperature ●
Oil pressure	●	Fuel pressure ●
Oil temperature	●	Fuel temperature ●
Coolant pressure	●	Water in fuel ●
Coolant temperature	●	Fuel consumption/rate (L/h) ●
Turbo pressure	●	Fuel used (L) ●
Atmospheric pressure	●	Battery voltage ●
Engine hours	●	Battery potential (voltage) ●

NOTE *External equipment can read all of these from the AGC Modbus server. Other EIC analogue readings may also be available.

3.28 YANMAR

3.28.1 YANMAR EDC17

ECU(s)	EDC17		
Engine(s)			
Engine interface protocol (parameter 7561)	YANMAR EDC17		
EIC control			
Start	●		
Stop	●		
Speed control	●		
Default speed control source address	3		
J1939 message	TSC1, CM1, GC1		
Idle mode	●		
50/60 Hz frequency selection	●		
Shutdown override	-		
Diagnostic messages			
DM1 Yellow lamp	●		
DM1 Red lamp	●		
DM1 Protect	●		
DM1 Malfunction	●		
DM2	●		
Emissions			
Tier 4/Stage V	-		
Force regeneration	-		
Inhibit regeneration	-		
Analogue readings*			
Engine speed	●	Inlet temperature	●
Percent load	●	Exhaust temperature	●
Oil pressure	●	Fuel pressure	●
Oil temperature	●	Fuel temperature	●
Coolant pressure	●	Water in fuel	●
Coolant temperature	●	Fuel consumption/rate (L/h)	●
Turbo pressure	●	Fuel used (L)	●
Atmospheric pressure	●	Battery voltage	●
Engine hours	●	Battery potential (voltage)	●

NOTE *External equipment can read all of these from the AGC Modbus server. Other EIC analogue readings may also be available.

3.28.2 YANMAR stage V

ECU(s)	EDC17		
Engine(s)			
Engine interface protocol (parameter 7561)	YANMAR stage V		
EIC control			
Start	-		
Stop	-		
Speed control	●		
Default speed control source address	3		
J1939 message	TSC1		
Idle mode	●		
50/60 Hz frequency selection	●		
Shutdown override	-		
Proprietary message(s)	FF18, FF1C		
Diagnostic messages			
DM1 Yellow lamp	●		
DM1 Red lamp	●		
DM1 Protect	●		
DM1 Malfunction	●		
DM2	●		
Emissions			
Tier 4/Stage V	●		
Force regeneration	●		
Inhibit regeneration	●		
Analogue readings*			
Engine speed	●	Inlet temperature	-
Percent load	●	Exhaust temperature	-
Oil pressure	-	Fuel pressure	-
Oil temperature	-	Fuel temperature	●
Coolant pressure	-	Water in fuel	-
Coolant temperature	●	Fuel consumption/rate (L/h)	●
Turbo pressure	-	Fuel used (L)	●
Atmospheric pressure	●	Battery voltage	●
Engine hours	●	Battery potential (voltage)	-

NOTE *External equipment can read all of these from the AGC Modbus server. Other EIC analogue readings may also be available.

3.29 Yuchai

3.29.1 Yuchai United Diesel

ECU(s)	YCGCU (Version 4.2)		
Engine(s)	Diesel		
Engine interface protocol (parameter 7561)	Yuchai United Diesel		
EIC control			
Start	-		
Stop	-		
Speed control	●		
Default speed control source address	3		
J1939 message	TSC1		
Idle mode	●		
50/60 Hz frequency selection	●		
Shutdown override	-		
Proprietary message(s)	-		
Diagnostic messages			
DM1 Yellow lamp	●		
DM1 Red lamp	●		
DM1 Protect	●		
DM1 Malfunction	●		
DM2	●		
Emissions			
Tier 4/Stage V	●		
Force regeneration	-		
Inhibit regeneration	-		
Analogue readings*			
Engine speed	●	Inlet temperature	●
Percent load	●	Exhaust temperature	-
Oil pressure	●	Fuel pressure	-
Oil temperature	●	Fuel temperature	●
Coolant pressure	-	Water in fuel	-
Coolant temperature	●	Fuel consumption/rate (L/h)	●
Turbo pressure	●	Fuel used (L)	-
Atmospheric pressure	●	Battery voltage	●
Engine hours	●	Battery potential (voltage)	●

NOTE *External equipment can read all of these from the AGC Modbus server. Other EIC analogue readings may also be available.

3.29.2 Yuchai United Gas

ECU(s)	YCGCU (Version 4.2)		
Engine(s)	Gas		
Engine interface protocol (parameter 7561)	Yuchai United Gas		
EIC control			
Start	-		
Stop	-		
Speed control	●		
Default speed control source address	3		
J1939 message	TSC1		
Idle mode	●		
50/60 Hz frequency selection	●		
Shutdown override	-		
Proprietary message(s)	-		
Diagnostic messages			
DM1 Yellow lamp	●		
DM1 Red lamp	●		
DM1 Protect	●		
DM1 Malfunction	●		
DM2	●		
Emissions			
Tier 4/Stage V	●		
Force regeneration	-		
Inhibit regeneration	-		
Analogue readings*			
Engine speed	●	Inlet temperature	●
Percent load	●	Exhaust temperature	-
Oil pressure	●	Fuel pressure	-
Oil temperature	●	Fuel temperature	●
Coolant pressure	-	Water in fuel	-
Coolant temperature	●	Fuel consumption/rate (L/h)	●
Turbo pressure	●	Fuel used (L)	-
Atmospheric pressure	●	Battery voltage	●
Engine hours	●	Battery potential (voltage)	●

NOTE *External equipment can read all of these from the AGC Modbus server. Other EIC analogue readings may also be available.

3.29.3 Yuchai United YC-BCR

ECU(s)	YC-BCR		
Engine(s)			
Engine interface protocol (parameter 7561)	Yuchai United YC-BCR**		
EIC control			
Start	●		
Stop	●		
Speed control	●		
Default speed control source address	3		
J1939 message	TSC1, CM1, GC1		
Idle mode	●		
50/60 Hz frequency selection	●		
Shutdown override	-		
Diagnostic messages			
DM1 Yellow lamp	●		
DM1 Red lamp	●		
DM1 Protect	●		
DM1 Malfunction	●		
DM2	●		
Emissions			
Tier 4/Stage V	-		
Force regeneration	-		
Inhibit regeneration	-		
Analogue readings*			
Engine speed	●	Inlet temperature	●
Percent load	●	Exhaust temperature	●
Oil pressure	●	Fuel pressure	●
Oil temperature	●	Fuel temperature	●
Coolant pressure	●	Water in fuel	●
Coolant temperature	●	Fuel consumption/rate (L/h)	●
Turbo pressure	●	Fuel used (L)	●
Atmospheric pressure	●	Battery voltage	●
Engine hours	●	Battery potential (voltage)	●

NOTE *External equipment can read all of these from the AGC Modbus server. Other EIC analogue readings may also be available.

NOTE ** Previously *Yuchai United EDC17*

3.29.4 Yuchai United YC-ECU

ECU(s)	YC-ECU		
Engine(s)			
Engine interface protocol (parameter 7561)	Yuchai United YC-ECU		
EIC control			
Start	●		
Stop	●		
Speed control	●		
Default speed control source address	3		
J1939 message	TSC1, CM1, GC1		
Idle mode	●		
50/60 Hz frequency selection	●		
Shutdown override	-		
Diagnostic messages			
DM1 Yellow lamp	●		
DM1 Red lamp	●		
DM1 Protect	●		
DM1 Malfunction	●		
DM2	●		
Emissions			
Tier 4/Stage V	-		
Force regeneration	-		
Inhibit regeneration	-		
Analogue readings*			
Engine speed	●	Inlet temperature	●
Percent load	●	Exhaust temperature	●
Oil pressure	●	Fuel pressure	●
Oil temperature	●	Fuel temperature	●
Coolant pressure	●	Water in fuel	●
Coolant temperature	●	Fuel consumption/rate (L/h)	●
Turbo pressure	●	Fuel used (L)	●
Atmospheric pressure	●	Battery voltage	●
Engine hours	●	Battery potential (voltage)	●

NOTE *External equipment can read all of these from the AGC Modbus server. Other EIC analogue readings may also be available.

4. CANopen ECUs and engines

4.1 MTU ADEC (CANopen)

MTU ADEC does not use J1939. The reading of values, alarms and shutdowns are different.

ECU(s)	ADEC
Engine(s)	Series 2000 and 4000 (ECU7), MTU PX ¹
Engine interface protocol (parameter 7561)	MTU ADEC
Protocol type	MTU CANopen
Option required	H12
Baud rate	125 kb/s

NOTE 1: For the AGC to support MTU PX engines, the MTU SAM module must have an updated J1939 protocol supporting DM1/DM2.

4.1.1 Warnings

Below is a list of warnings that can be shown on the display. Each warning is shown as an alarm in the alarm window. The alarms can be acknowledged from the display, but they will be visible until the alarm disappears in the ECU.

Warning	Display text
Coolant temp. high	HI T-Coolant
Charge air temp. high	HI T-Charge Air
Intercooler coolant temp. high	HI T-Coolant Interc
Lube oil temp. high	HI T-Lube Oil
ECU temp. high	HI T-ECU
Engine speed too low	SS Engine Speed Low
Prelube fail.	AL Prelub. Fail
Start speed not reached	AL Start Spe. N. Re.
Common alarm (yellow)	AL Com. Alarm Yellow
Lube oil pressure low	LO P-Lube Oil
Coolant level low	LO Coolant Level
Intercooler coolant level low	LO Interc. Cool. L.
ECU defect	AL ECU Defect
Speed demand failure	AL Speed Demand Def.
Power supply low voltage	LO Power Supply
Power supply high voltage	HI Power supply
Overspeed	SS Overspeed
Lube oil pressure low low	LOLO P-Lube Oil
Coolant temp. high high	HIHI T-Coolant
Lube oil temp. high high	HIHI T-Lube Oil
Charge air temp. high high	HIHI T-Charge Air

Warning	Display text
ECU power supply high high	HIHI ECU PS Voltage
ECU power supply low low	LOLO ECU PS Voltage
Generator temp. high	T-Generator Warning
Holding tank high level	HI Level Day-Tank
Holding tank low level	LO Level Day-Tank
Generator winding 1 high temp.	HI T-Winding 1
Generator winding 2 high temp.	HI T-Winding 2
Generator winding 3 high temp.	HI T-Winding 3
Ambient temp. high	HI T-Ambient
Water in fuel 1	AL Water I F. Pref. 1
Water in fuel 2	AL Water I F. Pref. 2
Fuel temp. high	HI T-Fuel
Exhaust bank A high temp.	HI T-Exhaust A
Exhaust bank B high temp.	HI T-Exhaust B
Fuel high pressure 1	HI Pressure 1
Fuel high pressure 2	HI Pressure 2
Day tank high level	HI L. Holding-Tank
Day tank low level	LO L. Holding-Tank
Run-up speed not reached	AL Runup. Speed N. Re
Idle speed not reached	AL Idle Speed N. Re

4.1.2 Shutdown

Below is a shutdown value that can be shown on the display. You can configure *EIC shutdown* in parameter 7590.

Shutdown	AGC display text
AL Com. Alarm Red	AL Com. Alarm Red

4.1.3 Display texts

Display readings
Ambient temperature
Battery
EIC faults
Engine power
Fuel rate
Mean T. fuel
Nom. power
Operation
P. Aux 1
P. Aux 2

Display readings

P. Boost

P. Fuel

P. Oil

Speed

T. Chrg A

T. Coolant

T. Exh. L

T. Exh. R

T. Fuel

T. Int. Co.

T. Oil

T. Winding 1

T. Winding 2

T. Winding 3

Trip fuel

4.1.4 Write commands

Use parameter 7563 (EIC Controls) to enable write commands.

The ADEC ID is selected in parameter 7562 and is 6 (the default for CANopen protocols).

MTU ADEC (CANopen) write commands

Command	Description
Speed control	To enable speed regulation, select EIC in parameter 2781 (Reg. output GOV). By default, the governor offset is 50 % of the nominal speed. At 0 % it is -120 RPM, and at 100 % it is +120 RPM. The CAN bus ID for speed control is $0 \times 300 + \text{ADEC ID}$ (the speed demand telegram). The CAN bus ID is therefore 0×306 .
Idle speed	See the J1939 command .
Start/Stop	See the J1939 command .
Frequency selection (50 or 60 Hz)	See the J1939 command .
Demand switch	Use menu 2790 to select the speed control type: <ul style="list-style-type: none">• Digital (<i>Up/down ECU with relay controls</i>)• Analogue (<i>Analog ECU Relative</i> for analogue VDC control)• J1939 commands (<i>Analog CAN</i>). See the MTU documentation for the ECU8 for more information about switching between normal and emergency operation in local or remote.
Trip counter	This command resets the trip fuel consumption counter. The command is activated through M-Logic (<i>Output, EIC commands, EIC Reset trip fuel</i>).
Shutdown override	See the J1939 command .
Enable Cylinder Cutout	The command can be used to engage all cylinders if the engine is running with one bank only. The command is activated through M-Logic (<i>Output, EIC commands, EIC Enable Cylinder Cutout</i>).

4.1.5 Modbus alarms

Alarm, status and measurement table (read only) function code 04h.

Addr.	Content	Bit	Type
1020	EIC alarms, DEIF controller	0	EIC 7570 communication error
		2	EIC 7590 shutdown
		3	EIC 7600 overspeed
		4	EIC 7610 coolant water temperature 1
		5	EIC 7620 coolant water temperature 2
		6	EIC 7630 oil pressure 1
		7	EIC 7640 oil pressure 2
		8	EIC 7650 oil temp. 1
		9	EIC 7660 oil temp. 2
		10	EIC 7670 coolant level 1
		11	EIC 7680 coolant level 2
1022	EIC alarms, engine controller	0	EIC ECU power supp voltage LoLo
		1	EIC Fuel high temp
		2	EIC Exhaust A high temp
		3	EIC Exhaust B high temp
		4	EIC Pressure 1 high (Aux 1)
		5	EIC Pressure 2 high (Aux 2)
		6	EIC Day tank high level
		7	EIC Day tank low level
		8	EIC Run-up speed not reached
9	EIC Idle speed not reached		

Addr.	Content	Bit	Type
1023	EIC alarms, engine controller	0	EIC Common alarm red
		1	EIC Overspeed
		2	EIC Lube oil press LowLow
		3	EIC Coolant temperature HiHi
		4	EIC Lube oil temp HiHi
		5	EIC Charge air temp HiHi
		6	EIC ECU power supp voltage HiHi
		7	EIC Generator temp high warning
		8	EIC Holding tank high level
		9	EIC Holding tank low level
		10	EIC Winding 1 temp high
		11	EIC Winding 2 temp high
		12	EIC Winding 3 temp high
		13	EIC Ambient temp high
		14	EIC Water in fuel 1
		15	EIC Water in fuel 2
1024	EIC alarms, engine controller	0	EIC Coolant high temp
		1	EIC Charge air high temp
		2	EIC Intercooler coolant high temp
		3	EIC Lube oil high temp
		4	EIC ECU high temp
		5	EIC Engine speed low
		6	EIC Prelube fail
		7	EIC Start speed not reached Common alarm
		8	EIC yellow
		9	EIC Lube oil pressure low
		10	EIC Coolant level low
		11	EIC Intercooler coolant level low
		12	EIC ECU defect
		13	EIC Speed demand defect
		14	EIC Power supply low voltage
		15	EIC Power supply high voltage

4.1.6 Modbus analogue values

The readings below are available in the Modbus protocol. Generic J1939 Modbus readings may also be available.

Measurement table (read only) function code 04h

Addr	Content	Unit	Scaling	SPN	Description
631	EIC Winding 1 temp	°C/°F	1/1	-	Gen winding 1 temp
632	EIC Winding 2 temp	°C/°F	1/1	-	Gen winding 2 temp

Addr	Content	Unit	Scaling	SPN	Description
633	EIC Winding 3 temp	°C/°F	1/1	-	Gen winding 3 temp
636	EIC T. Charge A	°C/°F	1/10	-	Turbo Charger Air temp
637	EIC Intercooler temp	°C/°F	1/10	52	Intercooler temp
900	EIC trip average fuel rate	L/h	1/10	1029	Average fuel rate
906	EIC mean trip fuel consumption	L/h	1/1000	1029	High word
907	EIC mean trip fuel consumption	L/h	1/1000	1029	Low word
908	EIC engine power	kWm	1/1	-	Nominal power of the engine (ADEC)
942	EIC camshaft	RPM	1/1	-	Camshaft speed
943	EIC Temp lube HI	°C/°F	1/10	-	Lube oil temperature HI
944	EIC Temp lube HIHI	°C/°F	1/10	-	Lube oil temperature HIHI
945	EIC speed demand analog	Digit	1/1	-	Speed demand analog

4.2 MTU ADEC module 501

MTU ADEC does not use J1939. The reading of values, alarms and shutdowns are different.

ECU(s)	ADEC, ECU7 without SAM module (software module 501)
Engine(s)	Series 2000 and 4000
Engine interface protocol (parameter 7561)	MTU ADEC module 501
Protocol type	MTU CANopen
Option required	H13
Baud rate	125 kb/s

4.2.1 Display texts

Display readings
Act-Droop
Battery
Camshaft
ECU Stop activated 1
F speed an
INJECT-QUAN
MDEC Faults
Mean T. fuel
Nom power
Operation
P L Oil Lo
P L Oil Lolo
P. Ch. Air
P. Fuel
P. Oil
Speed
Speed D SW
T. Ch. Air
T. Coolant
T. Fuel
T. Oil
TCOOL-HIHI
T-ECU
T-INTERC
T-LUBE-HI
T-LUBE-HIHI
Total fuel
Trip fuel

4.2.2 Displaying alarms

This is a list of alarms that can be shown on the display. The alarms will be shown in the alarm window. The alarms can be acknowledged from the display, but they will be visible until the alarm disappears in the ECU.

Alarm	Display text	Warning	Shutdown
ADEC yellow alarm	EIC yellow lamp WA	●	-
ADEC red alarm	EIC red lamp SD.	-	●
High high engine speed	Overspeed shutdown	●	-
Low low lube oil pressure	L Oil Pres. Shutdown	●	-
High high coolant temperature	H Coolant T Shutdown	●	-
High intercooler temperature	H Interc. T Warning	●	-
Sensor Defect Coolant Level	SD Coolant Level	●	-
Low low coolant level	L Cool. Lev. Shutdown	●	-
ADEC ECU failure	MDEC ECU Failure	●	-
Low Lube oil pressure	L Oil Pres. Warning	●	-
Low Common rail fuel pressure	LO P-Fuel Com-Rail	●	-
High Common rail fuel pressure	HI P-Fuel Com-Rail	●	-
Low preheat temperature	AL Preheat Temp. Low	●	-
Low low Charge air coolant level	SS Cool Level Ch-Air	●	-
Power amplifier 1 failure	AL Power Amplifier 1	●	-
Power amplifier 2 failure	AL Power Amplifier 2	●	-
Transistor output status	AL Status Trans-Outp	●	-
Low ECU power supply voltage	LO ECU Power Supply	●	-
High ECU power supply voltage	HI ECU Power	●	-
High charge air temperature	HI T-Charge Air	●	-
High Lube oil temperature	HI T-Lube Oil	●	-
High ECU temperature	HI T-ECU	●	-
Low engine speed	SS Eng. Speed Low	●	-
Check error code	AL Check Error Code	●	-
Common rail leakage	AL Com. Rail Leakage	●	-
Automatic engine stop	AL Aut. Engine Stop	●	-
MG Start speed not reached	MG Start Speed Fail	●	-
MG runup speed not reached	MG Runup Speed Fail	●	-
MG idle speed reached	MG Idle Speed Fail	●	-
Low low ECU power supply voltage	LOLO ECU Pow. Supply	●	-
High high ECU power supply voltage	HIHI ECU Pow. Supply	●	-
Sensor Defect coolant level charge air	SD Cool Level Ch-Air	●	-
High fuel temperature	HI T-Fuel	●	-
Override feedback from ECU	SS Override	●	-
High high lube oil temperature	H Oil Temp. Shutdown	●	-
Speed demand defected	AL Speed demand Def.	●	-

Alarm	Display text	Warning	Shutdown
High coolant temperature	H Coolant T Warning	●	-
High high temperature charge air	H Ch. Air T Shutdown	●	-
Low fuel oil pressure	LO P-Fuel Oil	●	-
Low low fuel oil pressure	SS P-Fuel Oil	●	-

NOTE "-" means that the alarm is not supported.

4.2.3 Write commands

Use parameter 7563 (EIC Controls) to enable write commands.

MTU ADEC module 501 (without SAM) write commands

Command	Description
Speed control	To enable speed regulation, select EIC in parameter 2781 (Reg. output GOV). By default, the governor offset is 50 % of the nominal speed. At 0 % it is -120 RPM, and at 100 % it is +120 RPM.
Idle speed	See the J1939 command .
Start/Stop	See the J1939 command .
Frequency selection (50 or 60 Hz)	See the J1939 command .
Demand switch	Use menu 2790 to select the speed control type: <ul style="list-style-type: none"> Digital (<i>Up/down ECU with relay controls</i>) Analogue (<i>Analog ECU Relative for analogue VDC control</i>) J1939 commands (<i>Analog CAN</i>). See the MTU documentation for the ECU8 for more information about switching between normal and emergency operation in local or remote.
Trip counter	This command resets the trip fuel consumption counter. The command is activated through M-Logic (<i>Output, EIC commands, EIC Reset trip fuel</i>).
Priming on engine start	Engage the pre-lubrication oil pump if installed. The command is activated through M-Logic (<i>Output, EIC commands, EIC Interval Priming</i>).
Shutdown override	See the J1939 command . The shutdown override can also be inhibited through M-Logic (<i>Output, EIC commands, EIC MTU inhibit Shutdown override</i>).
Enable Cylinder Cutout	The command can be used to engage all cylinders if the engine is running with one bank only. The command is activated through M-Logic (<i>Output, EIC commands, EIC Enable Cylinder Cutout</i>).
Speed increase	This command increases the speed of the engine by a small amount. The command is activated through M-Logic (<i>Output, EIC commands, EIC Speed Increase</i>).
Speed decrease	This command decreases the speed of the engine by a small amount. The command is activated through M-Logic (<i>Output, EIC commands, EIC Speed Decrease</i>).
Engine overspeed test	The ECU runs its overspeed test. The command is activated through M-Logic (<i>Output, EIC commands, EIC Engine overspeed test</i>).
Binary speed enable	The ECU uses (or does not use) EIC binary speed for the speed bias. The command is activated through M-Logic (<i>Output, EIC commands, EIC binary Speed In-De Enable</i>). The function is MTU-specific.
Inhibit AL speed demand	The command is activated through M-Logic (<i>Output, EIC commands, EIC MTU inhibit AL speed demand</i>). The function is MTU-specific.

4.2.4 Modbus alarms

Alarm, status and measurement table (read only) function code 04h.

Addr.	Content	Bit	Type
1020	EIC alarms, DEIF controller	0	EIC communication error
		2	EIC shutdown
		3	EIC overspeed
		4	EIC coolant water temperature 1
		5	EIC coolant water temperature 2
		6	EIC oil pressure 1
1022	EIC alarms, engine controller	0	EIC Automatic engine stop
		1	EIC MG start speedfail
		2	EIC Runup speedfail1
		3	EIC Idle speedfail
		4	EIC ECU power supply voltage low limit2
		5	EIC ECU power supply voltage high limit2
		6	EIC Aftercooler coolant level sensor defect
		7	EIC Fuel temperature high limit 2
1023	EIC alarms, engine controller	0	EIC Common rail fuel pressure limit 1
		1	EIC Common rail fuel pressure limit 2
		2	EIC Override
		3	EIC Preheat temperature low
		4	EIC Charge air coolant level 2
		5	EIC Power amplifier 1
		6	EIC Power amplifier 2
		7	EIC Transistor output status, TAA1 to TAA6
		8	EIC ECU Power supply voltage low limit1
		9	EIC ECU Power supply voltage high limit1
		10	EIC Charge air temperature limit1
		11	EIC Lube oil temperature limit1
		12	EIC ECU temperature limit1
		13	EIC Engine speed low limit1
		14	EIC Check error code
15	EIC Common rail leakage		

Addr.	Content	Bit	Type
1024	EIC alarms, engine controller	0	EIC overspeed, shutdown
		1	EIC low oil pressure, warning
		2	EIC low oil pressure, shutdown
		3	EIC low coolant level, shutdown
		4	EIC ADEC ECU failure, shutdown
		5	EIC high coolant temperature, warning
		6	EIC high coolant temperature, shutdown
		7	EIC high intercooler coolant temp, warning
		8	EIC high oil temperature, shutdown
		9	EIC high charge air temperature, shutdown
		10	EIC defect coolant level switch, warning
		11	EIC ADEC yellow alarm, warning
		12	EIC ADEC red alarm, shutdown
		13	EIC communication error
		14	EIC fuel delivery pressure limit1
		15	EIC fuel delivery pressure limit2

4.3 MTU ECU7 with SAM

MTU ECU7 with SAM does not use J1939. The reading of values, alarms and shutdowns are different.

ECU(s)	ECU7 with SAM module
Engine(s)	
Engine interface protocol (parameter 7561)	MTU ECU7 with SAM
Protocol type	MTU CANopen
Option required	H12
Baud rate	125 kb/s

4.4 MTU MDEC module 201

MTU MDEC does not use J1939. The reading of values, alarms and shutdowns are different.

ECU(s)	MDEC module M.201
Engine(s)	
Engine interface protocol (parameter 7561)	MDEC 2000/4000 M.201
Protocol type	MTU CANopen
Option required	H12
Baud rate	125 kb/s

4.5 MTU MDEC module 302/303

4.5.1 MTU MDEC module 302

MTU MDEC does not use J1939. The reading of values, alarms and shutdowns are different.

ECU(s)	MDEC module M.302
Engine(s)	Series 2000 and 4000
Engine interface protocol (parameter 7561)	MDEC 2000/4000 M.302
Protocol type	MTU CANopen
Option required	H12
Baud rate	125 kb/s

4.5.2 MTU MDEC module 303

MTU MDEC does not use J1939. The reading of values, alarms and shutdowns are different.

ECU(s)	MDEC module M.303
Engine(s)	Series 2000 and 4000
Engine interface protocol (parameter 7561)	MDEC 2000/4000 M.303
Protocol type	MTU CANopen
Option required	H12
Baud rate	125 kb/s

4.5.3 Displaying alarms

Below is a list of alarms that can be shown on the display. The alarms will be shown in the alarm window. The alarms can be acknowledged from the display, but they will be visible until the alarm disappears in the ECU.

Alarm	Display text	Warning	Shutdown
MDEC yellow alarm	EIC yellow lamp	●	-
MDEC red alarm	EIC red lamp SD.	-	●
High high engine speed	Overspeed shutdown	-	●
Low low lube oil pressure	L Oil Pres. Shutdown	●	●
High high coolant temperature	H Coolant T Shutdown	●	●
High high lube oil temperature	H Oil Temp. Shutdown	-	●
High intercooler temperature	H Interc. T Warning	●	-
Sensor Defect Coolant Level	SD Coolant Level	●	-
Low low coolant level	L Cool. Lev. Shutdown	-	●
MDEC ECU failure	MDEC ECU Failure	-	●
Low fuel oil pressure	LO P-Fuel Oil	●	-
Low Lube oil pressure	L Oil Pres. Warning	●	-
Low Common rail fuel pressure	LO P-Fuel Com-Rail	●	-
High Common rail fuel pressure	HI P-Fuel Com-Rail	●	-
Override feedback from ECU	SS Override	●	-

Alarm	Display text	Warning	Shutdown
Low preheat temperature	AL Preheat Temp. Low	●	-
Low low Charge air coolant level	SS Cool Level Ch-Air	●	-
Power amplifier 1 failure	AL Power Amplifier 1	●	-
Power amplifier 2 failure	AL Power Amplifier 2	●	-
Transistor output status	AL Status Trans-Outp	●	-
Low ECU power supply voltage	LO ECU Power Supply	●	-
High ECU power supply voltage	HI ECU Power	●	-
High charge air temperature	HI T-Charge Air	●	-
High Lube oil temperature	HI T-Lube Oil	●	-
High ECU temperature	HI T-ECU	●	-
Low engine speed	SS Eng. Speed Low	●	-
Check error code	AL Check Error Code	●	-
Common rail leakage	AL Com. Rail Leakage	●	-
Automatic engine stop	AL Aut. Engine Stop	●	-
MG Start speed not reached	MG Start Speed Fail	●	-
MG runup speed not reached	MG Runup Speed Fail	●	-
MG idle speed reached	MG Idle Speed Fail	●	-
Low low ECU power supply voltage	LOLO ECU Pow. Supply	●	-
High high ECU power supply voltage	HIHI ECU Pow. Supply	●	-
Sensor Defect coolant level charge air	SD Cool Level Ch-Air	●	-
High fuel temperature	Hi T-Fuel	●	-

NOTE "-" means that the alarm is not supported.

4.5.4 Display texts

Display readings
Act-Droop
Battery
Camshaft
ECU Stop activated 1
F speed an
Fuel Rate
INJECT-QUAN
MDEC Faults
Mean T. fuel
Nom power
Operation
P L Oil Lo
P LOil Lolo
P. Ch. Air

Display readings

P. Fuel

P. Oil

Speed

Speed D SW

T. Ch. Air

T. Coolant

T. Fuel

T. Oil

T-COOL-HI

TCOOL-HIHI

T-ECU

T-INTERC

T-LUBE-HI

T-LUBE-HIHI

Total fuel

Trip fuel

4.5.5 Write commands

Use parameter 7563 (EIC Controls) to enable write commands.

MTU MDEC module 302/303 write commands

Command	Description
Speed control	To enable speed regulation, select EIC in parameter 2781 (Reg. output GOV).
Reset trip fuel value	MDEC 303 only: The AGC can send this command to the ECU. The command is activated through M-Logic (<i>Output, EIC commands, EIC Reset trip fuel</i>).
Shutdown override	This command can be used in order to prevent shutdown actions from the ECU. The function is activated by the standard AGC function <i>Shutdown override</i> (digital input on the AGC). The shutdown override can also be inhibited through M-Logic (<i>Output, EIC commands, EIC MTU inhibit Shutdown override</i>).
Inhibit AL speed demand	The command is activated through M-Logic (<i>Output, EIC commands, EIC MTU inhibit AL speed demand</i>). The function is MTU-specific.

4.5.6 Modbus alarms

Alarm, status and measurement table (read-only) function code 04h. For MTU MDEC series - 2000/4000 - module 302 & 303.

Addr.	Content	Bit	Type
1020	EIC alarms, DEIF controller	0	EIC communication error
		2	EIC shutdown
		3	EIC overspeed
		4	EIC coolant water temperature 1
		5	EIC coolant water temperature 2
		6	EIC oil pressure 1
		7	EIC oil pressure 2
1022	EIC alarms, engine controller	0	EIC Automatic engine stop
		1	EIC MG start speed fail
		2	EIC Runup speed fail
		3	EIC Idle speed fail
		4	EIC ECU power supply voltage low limit 2
		5	EIC ECU power supply voltage high limit 2
		6	EIC Aftercooler coolant level sensor defect
		7	EIC Fuel temperature high limit 2
1023	EIC alarms, engine controller	0	EIC Common rail fuel pressure limit 1
		1	EIC Common rail fuel pressure limit 2
		2	EIC Override
		3	EIC Preheat temperature low
		4	EIC Charge air coolant level 2
		5	EIC Power amplifier 1
		6	EIC Power amplifier 2
		7	EIC Transistor output status, TAA1 to TAA6
		8	EIC ECU Power supply voltage low limit 1
		9	EIC ECU Power supply voltage high limit 1
		10	EIC Charge air temperature limit 1
		11	EIC Lube oil temperature limit 1
		12	EIC ECU temperature limit 1
		13	EIC Engine speed low limit 1
		14	EIC Check error code
15	EIC Common rail leakage		

Addr.	Content	Bit	Type
1024	EIC alarms, engine controller	0	EIC overspeed, shutdown
		1	EIC low oil pressure, warning
		2	EIC low oil pressure, shutdown
		3	EIC low coolant level, shutdown
		4	EIC MDEC ECU failure, shutdown
		5	EIC high coolant temperature, warning
		6	EIC high coolant temperature, shutdown
		7	EIC high intercooler coolant temp, warning
		8	EIC high oil temperature, shutdown
		9	EIC high charge air temperature, shutdown
		10	EIC defect coolant level switch, warning
		11	EIC MDEC yellow alarm, warning
		12	EIC MDEC red alarm, shutdown
		13	EI communication error
		14	EIC fuel delivery pressure limit 1
		15	EIC fuel delivery pressure limit 2

4.5.7 Modbus analogue values

The readings below are available in the Modbus protocol.

Measurement table (read only) function code 04h

Addr	Content	Unit	Scaling	Description
593	EIC speed	RPM	1/1	Speed
594	EIC coolant temp.	°C/°F	1/10	Coolant temperature
595	EIC oil pressure	bar/psi	1/100	Engine oil pressure
596	EIC no of faults	Faults	1/1	Number of faults
597	EIC oil temp.	°C/°F	1/10	Engine oil temperature
598	EIC fuel temp.	°C/°F	1/10	Fuel temperature
603	EIC charge air press	bar/psi	1/100	Charge air press
604	EIC intake manifold 1 T (or EIC charge air T)	°C/°F	1/10	Intake manifold 1 temperature
611	EIC engine hours	h	1/1	ENGINE HOURS
932	EIC Speed Demand source	Digit	1/1	Identifies speed dem. source 0, Default Dataset ADEC 1, ADEC Incr./Decr. Input 2, CAN Incr./Decr. Input 3, ADEC Analog Absolute 4, ADEC Analog Relative 5, ADEC Frequency Input 6, CAN analog
933	EIC lube oil pressure LO limit	mbar	1/100	Lubrication oil pressure limit 1
934	EIC lube oil pressure LOLO limit	mbar	1/100	Lubrication oil pressure limit 2
935	EIC fuel pressure	bar/psi	1/100	Fuel pressure

Addr	Content	Unit	Scaling	Description
936	EIC coolant limit HI	°C/°F	1/10	Coolant high limit temp. 1
937	EIC coolant limit HIHI	°C/°F	1/10	Coolant high limit temp. 2
938	EIC intercooler coolant	°C/°F	1/10	Intercooler coolant temperature
939	T-ECU	°C/°F	1/10	ECU temperature
940	EIC actual droop	%	1/10	Actual droop percentage
941	EIC act. inject. Quantity	%	1/10	Injection quantity Act. DBR %
946	ECU Stop activated #	bit	Boolean	1: Stop activated, 0: Stop not activated

4.6 MTU MDEC module 304 overview

MTU MDEC does not use J1939. The reading of values, alarms and shutdowns are different.

ECU(s)	MDEC, module M.304
Engine(s)	Series 2000 and 4000
Engine interface protocol (parameter 7561)	MDEC 2000/4000 M.304
Protocol type	MTU CANopen
Option required	H12
Baud rate	125 kb/s

4.6.1 Write commands

Use parameter 7563 (EIC Controls) to enable write commands.

MTU MDEC module 201/304 write command

Command	Description
Speed control	To enable speed regulation, select EIC in parameter 2781 (Reg. output GOV).

4.7 QiYao

QiYao Gas does not use J1939. The reading of values, alarms and shutdowns are different.

ECU(s)	
Engine(s)	QiYao Gas
Engine interface protocol (parameter 7561)	QiYao Gas
Protocol type	CANopen
Option required	H12
Baud rate	125 kb/s



More information

See **MTU ADEC (CANopen)** for warnings, shutdown, display texts, write commands, Modbus alarms, and Modbus analogue values.