

AGC 150

Generator, Mains and BTB

Data sheet

49212406189



1. AGC 150 Generator, Mains and BTB

1.1 About	4
1.1.1 Software packages.....	4
1.2 Single-line application diagrams	4
1.2.1 Single generator applications.....	4
1.2.2 Multiple generator applications.....	5
1.2.3 Power management applications.....	7
1.3 Power management	9
1.3.1 Introduction.....	9
1.3.2 Power management plant modes.....	10
1.3.3 Power management features.....	10
1.4 Functions and features	11
1.4.1 General controller functions.....	11
1.4.2 Emulation.....	12
1.4.3 Easy configuration with the utility software.....	13
1.5 Protections overview	13

2. AGC 150 Generator controller

2.1 Display, buttons and LEDs	15
2.2 Typical wiring for generator controller	16
2.3 Generator controller functions	17
2.4 Supported controllers and engines	19
2.5 Exhaust after-treatment (Tier 4/Stage V)	23

3. AGC 150 Mains controller

3.1 Display, buttons and LEDs	26
3.2 Typical wiring for mains controller	27
3.3 Mains controller functions	27

4. AGC 150 BTB controller

4.1 Display, buttons and LEDs	29
4.2 Typical wiring for BTB controller	30
4.3 BTB controller functions	30

5. Compatible products

5.1 Touch display unit: TDU	31
5.2 Power management	31
5.3 Open PMS	31
5.4 Remote monitoring service: Insight	31
5.5 Digital voltage controllers	32
5.6 Additional inputs and outputs	32
5.7 Additional operator panel, AOP-2	32
5.8 Remote display: AGC 150	32
5.9 Shutdown unit, SDU 104	32
5.10 Other equipment	32
5.11 Controller types	33

6. Technical specifications

6.1 Electrical specifications	34
6.2 Environmental specifications	37
6.3 UL/cUL Listed	38

6.4 Communication	38
6.5 Approvals	39
6.6 Dimensions and weight	39
7. Legal information	
7.1 Software version	41

1. AGC 150 Generator, Mains and BTB

1.1 About

The AGC 150 Generator (Genset), AGC 150 Mains and AGC 150 BTB controllers provide flexible protection and control in a wide range of applications.

In the simplest applications, you can use one AGC 150 Generator controller to control one genset. You can also use AGC 150 Generator controllers for CANshare load sharing by multiple gensets (without power management).

Several AGC 150 controllers can work together to make a power management system (PMS). These applications include synchronisation, island operation, and running parallel to mains. The PMS can automatically start and stop gensets, and open and close breakers. You can also use AGC 150 in power management systems with other DEIF controllers.

The AGC 150 Generator controller contains all the functions needed to protect and control a genset, and the genset breaker. If you do not use power management, the controller can also protect and control the mains breaker.

The AGC 150 Mains controller protects and controls a mains breaker, and a tie breaker.

The AGC 150 BTB controller protects and controls a bus tie breaker. The PMS manages the busbar sections.

The AGC 150 is a compact, all-in-one controller. Each AGC 150 contains all necessary 3-phase measuring circuits.

The values and alarms are shown on the LCD display screen, which is sunlight-readable. Operators can easily control the gensets and breakers from the display units. Alternatively, use the communication options to connect to an HMI/SCADA system. The HMI/SCADA system can then control the plant.

1.1.1 Software packages

You can choose the **Core**, **Extended** and **Premium** software packages. The functions depend on the controller type.

1.2 Single-line application diagrams

1.2.1 Single generator applications

Island mode

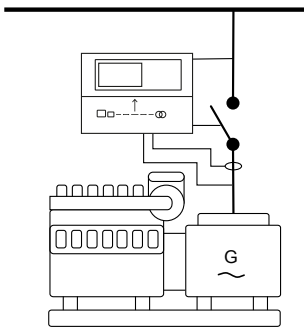

Island mode operation is typically used in power plants that are isolated from the national (or local) electricity distribution network. There are two key types of island mode operation:

- Stand-alone generators not connected to the electricity grid.
- Generators connected to the electricity grid in parallel mode. This means that they can generate power independently, and on demand.

Automatic mains failure (AMF) and fixed power

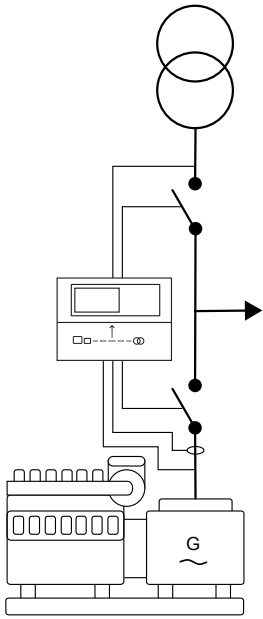

Automatic Mains Failure (AMF): If there is a significant loss of mains power or a total blackout, the controller automatically changes the supply to the emergency generator. This makes sure that there is power during a mains failure and prevents damage to electrical equipment.

Fixed power: When given a signal, the controller automatically starts the genset and synchronises to the mains. After the generator breaker closes, the controller ramps up the load to the set point level. When the stop command is given, the genset is de-loaded and stopped after the cooling down period.

Peak shaving, load take-over and mains power export

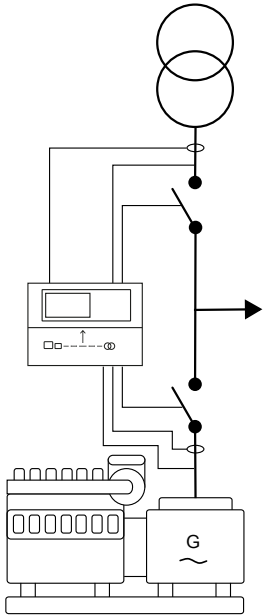

- **Peak shaving:** Power plant where the generator supplies the peak load demand and runs parallel to mains.
- **Load take-over:** Plant mode where the load is moved from mains to generator, for example, during peak demand periods or periods with a risk of power outages.
- **Mains power export:** Power plant with fixed kW set point (excluding increasing load).

1.2.2 Multiple generator applications

These applications can share the load without using power management. However, the generators do not automatically start, stop, connect, and disconnect.

Analogue load sharing (with optional IOM 230 external box)

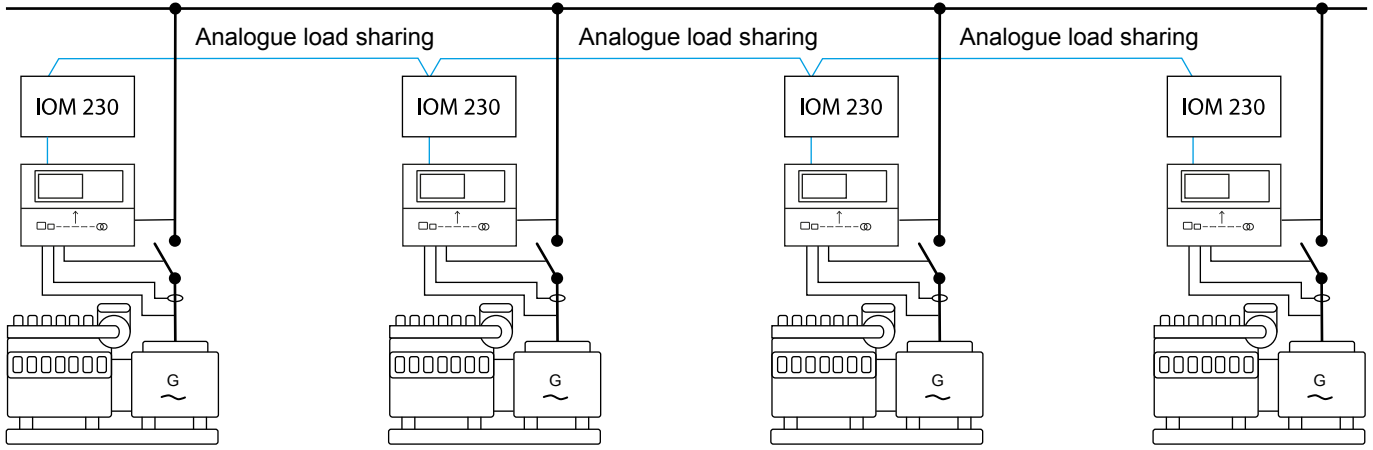

Analogue load sharing with 3rd party controllers

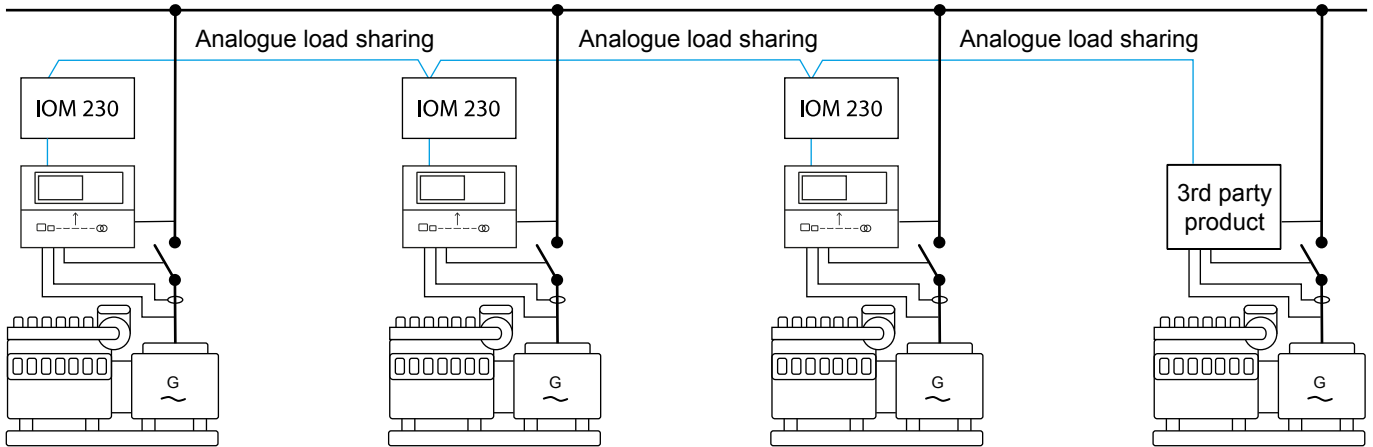

Digital load sharing (CANshare) (up to 127 generators)

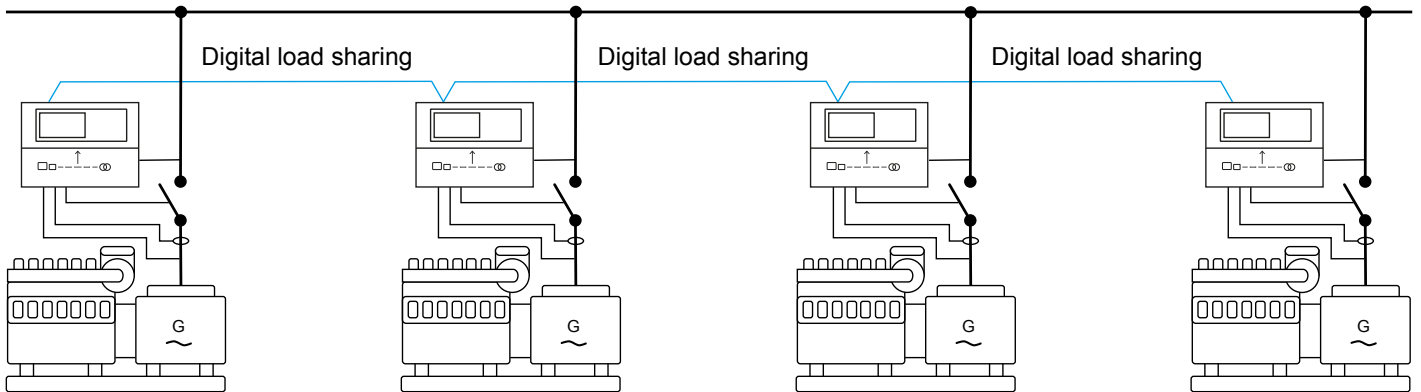

Digital load sharing with bus tie breakers (CANshare) (up to 127 generators, and up to 64 busbars)

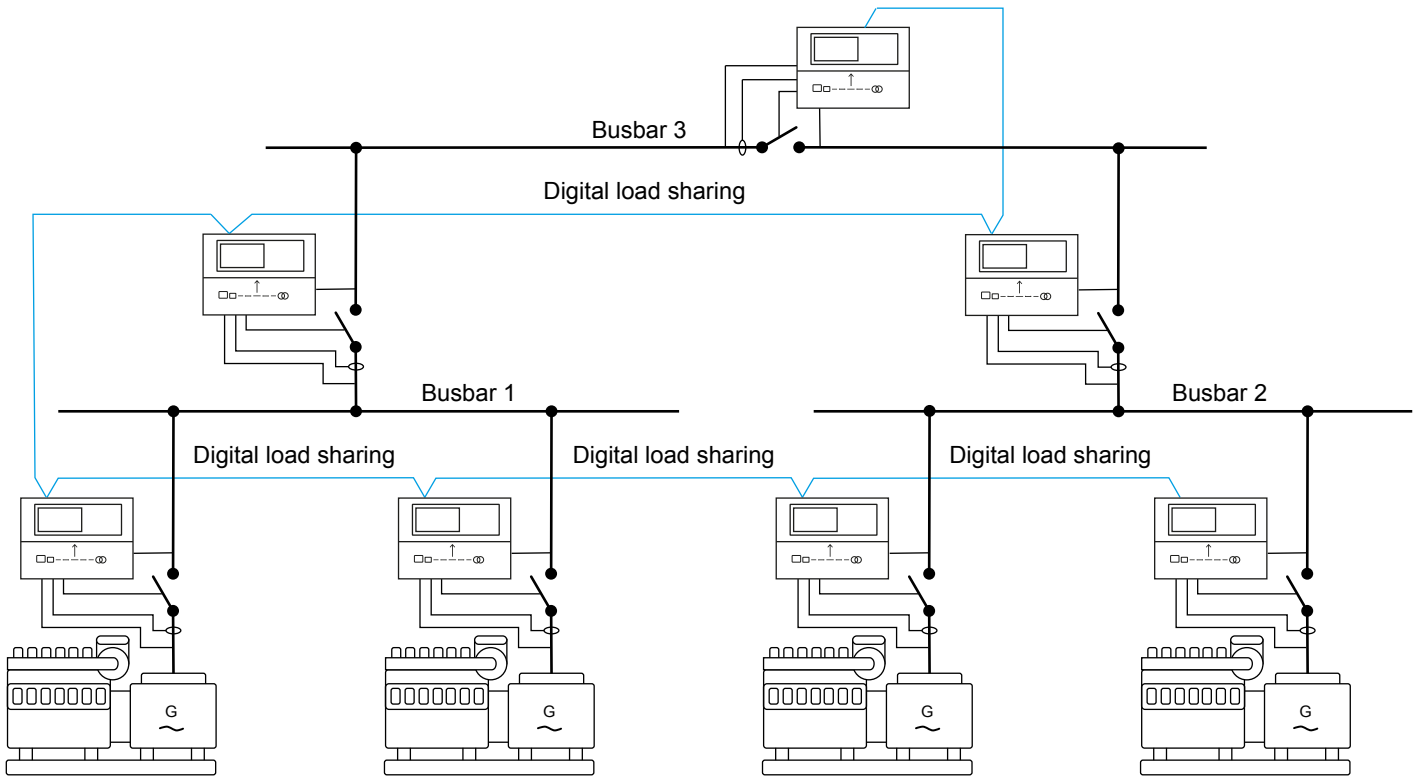

1.2.3 Power management applications

In power management, the controllers have the information that they need to automatically start, stop, connect and disconnect generators and/or mains. See [Power management](#) for more information.

Island operation in power management

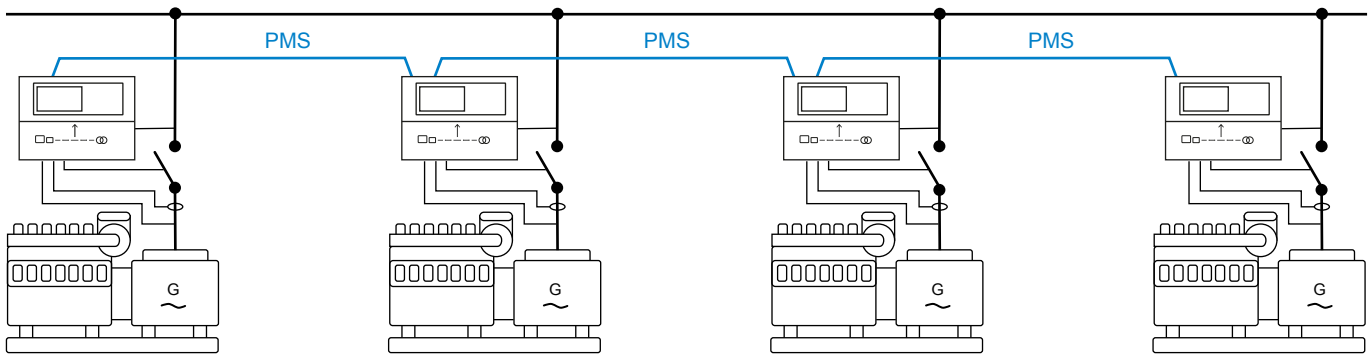

Power plant with synchronising generators. Can also be used in critical power plants with a start signal from an external (ATS) controller.

Gensets in power management with three mains and two sections

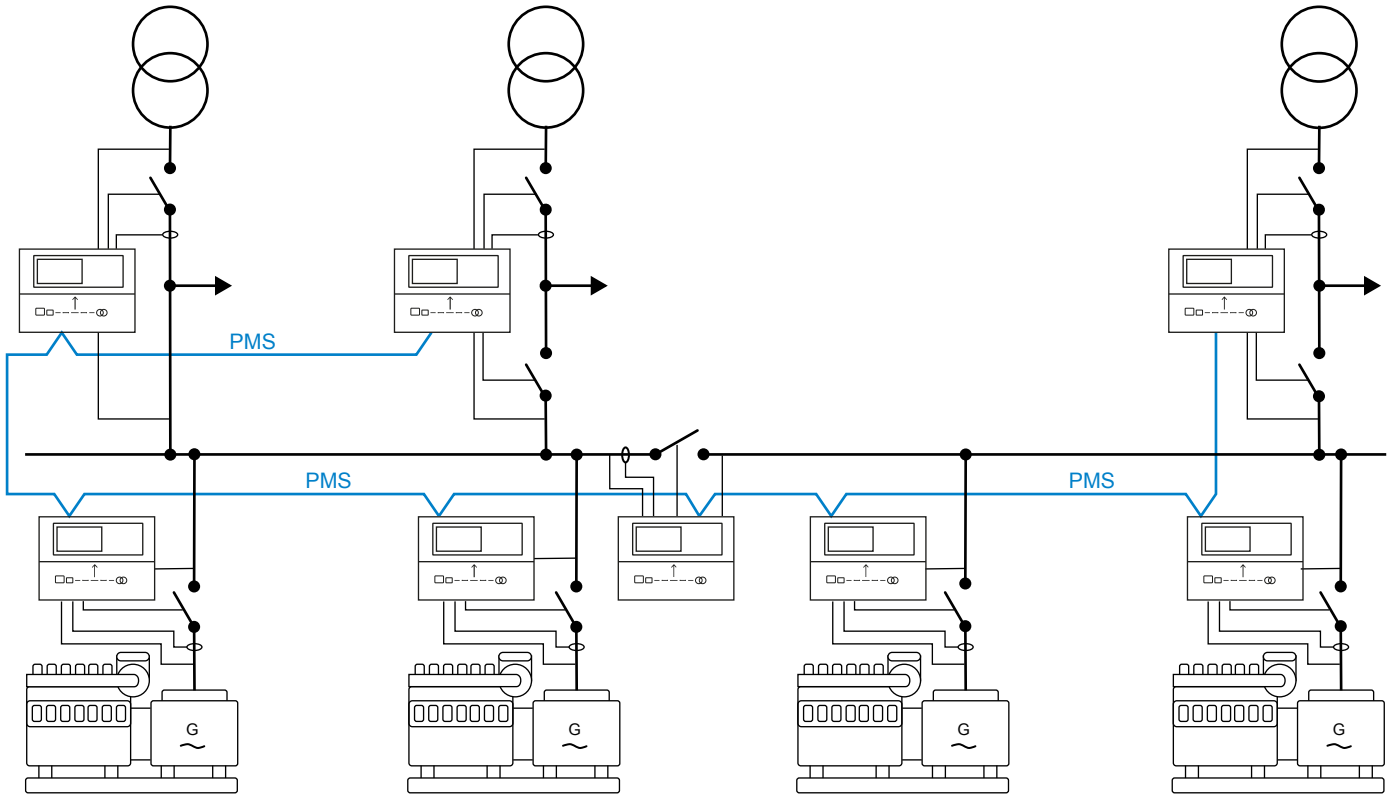

Using Ethernet backup for power management

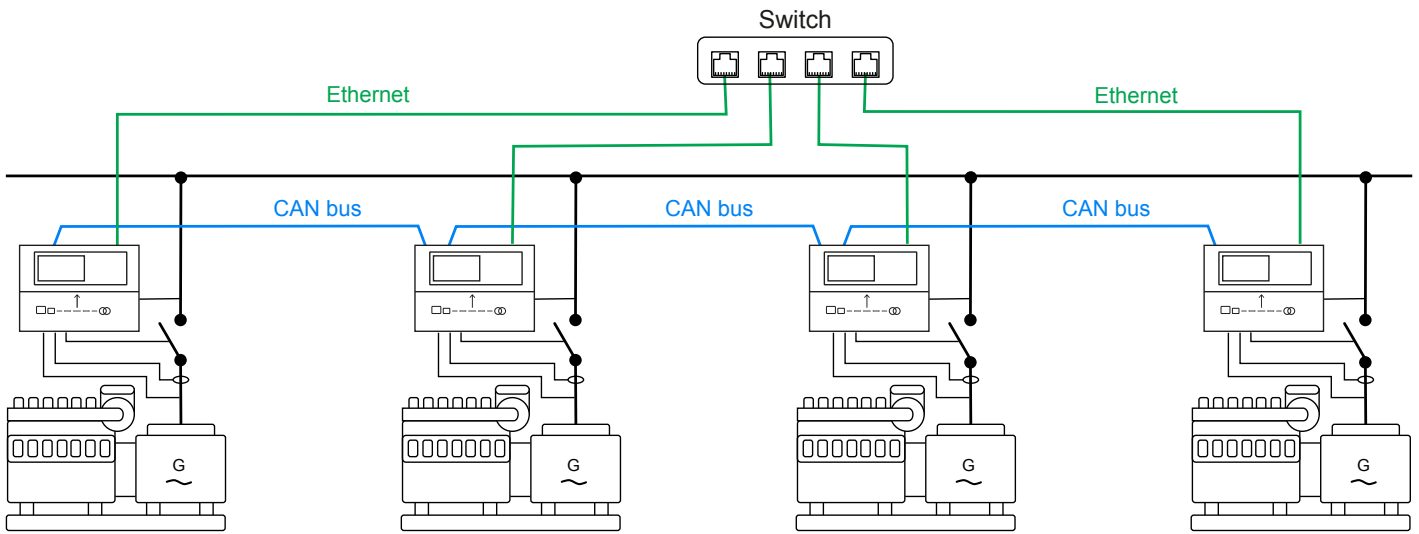

AGC 150 in power management with solar and battery controllers

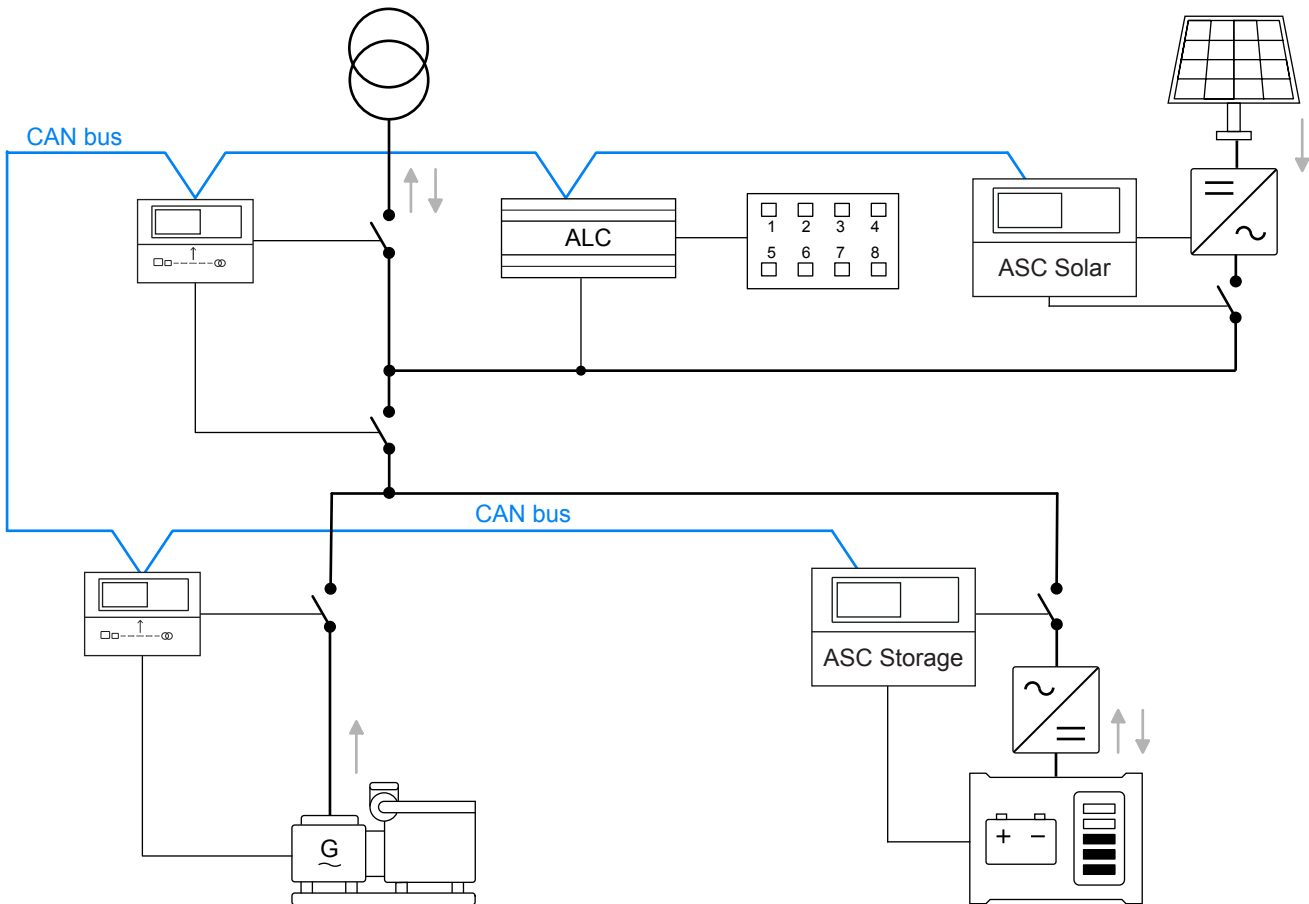

NOTE You can use AGC 150 generator, mains, and bus tie breaker controllers for power management in a hybrid system. However, the AGC 150 hybrid controller cannot be used in a power management application. To control the photovoltaic (PV) power source(s), use ASC Solar.

1.3 Power management

1.3.1 Introduction

The power management system automatically supplies the power that is necessary for the load efficiently, safely and reliably.

The power management system:

- Automatically starts and stops generators
- Automatically closes and opens breakers
- Optimises the fuel consumption
- Balances the loads in the system
- Deploys plant logic
- Makes sure that the system is safe

You can monitor the complete power management system from a graphical supervision page in the utility software. You can also see running status, hours in operation, breaker status, the condition of the mains and busbars, fuel consumption, and so on.

Multi-master system

The power management system is a multi-master system, for increased reliability. In a multi-master system all vital data is transmitted between the controllers, so that all the controller know the power management status (calculations and position) in the application. As a result, the application does not have a single master controller.

Busbar sections

The plant can be divided by one to eight bus tie breakers. This makes it possible to run different sections of the plant in different plant modes. For example, you can use this to test a section, or to divide the load into primary and secondary loads.

1.3.2 Power management plant modes

The plant modes are configurable and can be changed at any time. All modes can be combined with Automatic Mains Failure mode (AMF). You can use the controllers for the following applications:

Standard plant modes	Applications
Island mode	Power plant with synchronising generators.
Automatic Mains Failure	Critical power/emergency standby plants, black start generator.
Fixed power	Power plant with fixed kW set point (including building load).
Peak shaving	Power plant where generator supplies peak load demand paralleled to the mains.
Load take-over	Plant mode where the load is moved from mains to generator. For example, peak demand periods, or periods with a risk of power outages.
Mains power export	Power plant with fixed kW set point (excluding building load).

1.3.3 Power management features

Power management features	Core	Extended	Premium
Power management operation**:			
• Number of generator controllers	16	32	32
• Number of mains controllers	8	32	32
• Number of BTB controllers	8	8	8
• Number of solar controllers	16*	16	16
• Number of storage (BESS) controllers	16*	16	16
• Number of load controllers (ALC-4)	8	8	8
Load controller support (compatible with ALC-4)		●	●
Genset load-dependent start and stop	●	●	●
EasyConnect	●	●	●
Asymmetrical genset load sharing		●	●
N + X (Secured mode)		●	●
Genset priority selection:			
• Manual	●	●	●
• Running hours	●	●	●
• Fuel optimisation			●
Safety stop of genset	●	●	●
PLC-controlled power management possible	●	●	●
Redundant PMS via Ethernet			●

NOTE * The ASC 150 controllers must have *Extended* or *Premium* software. However, ASC 150 controllers can be used in an energy/power management system with AGC 150 controllers that have *Core* software.

** Restrictions on controllers

ID 1 to 24	ID 25 to 32	ID 33 to 40
AGC Genset (1 to 32)		
AGC Mains (1 to 32)		
	ASC Solar (25 to 40)	
	ASC Storage/Battery (25 to 40)	
	ALC-4 (25 to 40)	
		AGC BTB (33-40)
		External BTB (33-40)

Alternatives to power management

AGC 150 PMS lite: For simple load sharing and power management over CANshare, for up to 127 generators. Only for generators - other power sources are not possible. You can also use AGC-4 Mk II generator controllers for PMS lite. See the **AGC 150 PMS lite Data sheet**.

AGC 150 DG Hybrid: For a system that includes gensets, up to 16 inverters, and a mains connection. If there is a mains, there can be one genset. If there is no mains, there can be up to two synchronising gensets, or up to four non-synchronising gensets. See the **AGC 150 Hybrid Data sheet**.

Open PMS: Used to add solar, storage, and/or mains controllers to brownfield sites that have genset and/or mains controllers from other suppliers. You can use AGC 150 Generator controllers as external gensets.

1.4 Functions and features

1.4.1 General controller functions

AC functions	Core	Extended	Premium
Sets of nominal settings	4	4	4
Select the AC configuration: <ul style="list-style-type: none"> 3-phase/3-wire 3-phase/4-wire 2-phase/3-wire (L1/L2/N or L1/L3/N) 1-phase/2-wire L1 	● ● ● ●	● ● ● ●	● ● ● ●
100 to 690 V AC (selectable)	●	●	●
CT -/1 or -/5 (selectable)	●	●	●
4th current measurement (select one) <ul style="list-style-type: none"> Mains current (and power) Tie current (and power) Neutral current (1 × true RMS) Ground current (with 3rd harmonic filter) 	●	●	●

General functions	Core	Extended	Premium
Emulation for testing and front load commissioning	●	●	●
Built-in test sequences (Simple test, Load test, Full test, and Battery test)	●	●	●

General functions	Core	Extended	Premium
PLC logic (M-Logic)	20 lines	40 lines	80 lines
Counters, including:	●	●	●
• Breaker operations	●	●	●
• kWh meter (day, week, month, total)	●	●	●
• kvarh meter (day, week, month, total)	●	●	●
General purpose PID regulators (2 x built-in analogue outputs)			●
4 additional analogue outputs (using 2 x IOM 230)			●
Simple load shedding and adding		●	●
Changeable controller type		●	●
Configure and connect AOP-2s (additional operator panel)	1	1	2
TDU support			●

Setting and parameter functions	Core	Extended	Premium
Quick setup (for example, for rental applications)	●	●	●
User-defined permission level	●	●	●
Password-protected setup	●	●	●
Trending with the USW	●	●	●
Event logs with password, up to 500 entries	●	●	●

Display and language functions	Core	Extended	Premium
Supports multiple languages (including Chinese, Russian, and other languages with special characters)	●	●	●
20 configurable graphical screens	●	●	●
Graphical display with six lines	●	●	●
Parameters can be changed on the display unit	●	●	●
3 engine function shortcuts	●	●	●
20 configurable shortcut buttons	●	●	●
5 configurable display screen "LED lamps" (on/off/blink)	●	●	●

Modbus functions	Core	Extended	Premium
Modbus RS-485	●	●	●
Modbus TCP/IP	●	●	●
Configurable Modbus area	●	●	●

1.4.2 Emulation

AGC 150 includes an emulation tool to verify and test the functionality of the application, for example plant modes and logics, breaker handling, mains and generator operation.

Application emulation is useful for training, customising plant requirements and for testing basic functionality that needs to be set up or verified.

In a power management system it is possible to control the entire plant, when connected to just one of the controllers.

1.4.3 Easy configuration with the utility software

Set up an application easily with a PC and the utility software. This includes mains feeder handling and operation of the generators.

You can also use the utility software to quickly configure the inputs, outputs, and parameters.

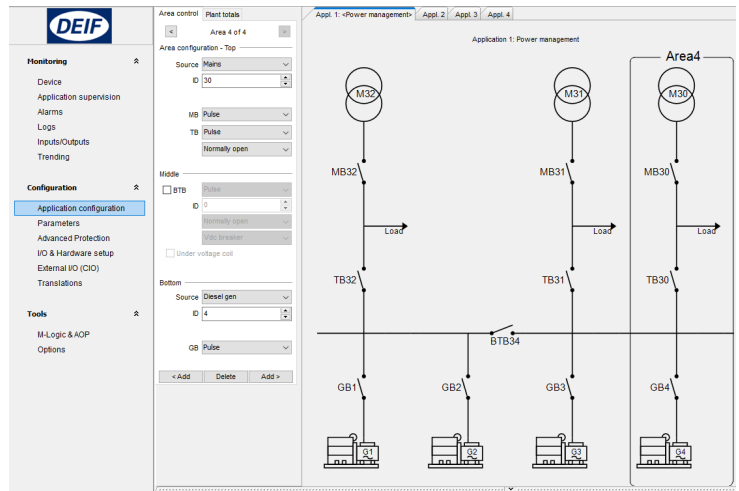

1.5 Protections overview

Protections	Alarms	ANSI	Operate time	Genset*	Mains	BTB
Reverse power	3	32R	<200 ms	●	●	●
Fast over-current	2	50P	<40 ms	●	●	●
Over-current	4	50TD	<200 ms	●	●	●
Voltage dependent over-current	1	50V		●	●	●
Over-voltage	2	59	<200 ms	●	●	●
Under-voltage	3	27P	<200 ms	●	●	●
Over-frequency	3	81O	<300 ms	●	●	●
Under-frequency	3	81U	<300 ms	●	●	●
Unbalanced voltage	1	47	<200 ms	●	●	●
Unbalanced current	1	46	<200 ms	●	●	●
Under-excitation or reactive power import	1	32RV	<200 ms	●		
Over-excitation or reactive power export	1	32FV	<200 ms	●		
Overload**	5	32F	<200 ms	●	●	●
Inverse time earth over-current	1	50G	<100 ms	●	●	●
Inverse time neutral over-current	1	50N	<100 ms	●	●	●
Busbar/mains over-voltage	3	59P	<50 ms	●	●	●
Busbar/mains under-voltage	4	27P	<50 ms	●	●	●
Busbar/mains over-frequency	3	81O	<50 ms	●	●	●
Busbar/mains under-frequency	3	81U	<50 ms	●	●	●
Emergency stop	1		<200 ms	●		
Low auxiliary supply	1	27DC		●	●	●
High auxiliary supply	1	59DC		●	●	●
Generator breaker external trip	1			●		

Protections	Alarms	ANSI	Operate time	Genset*	Mains	BTB
Tie breaker external trip	1				●	●
Mains breaker external trip	1				●	
Synchronisation failure alarms	1/breaker			●	●	●
Breaker open failure	1/breaker	52BF		●	●	●
Breaker close failure	1/breaker	52BF		●	●	●
Breaker position failure	1/breaker	52BF		●	●	●
Close before excitation failure	1			●		
Phase sequence error	1	47		●	●	●
De-load error	1			●		
Hz/V failure	1			●		
Not in Auto	1			●	●	●
Vector shift	1	78	<40 ms	●	●	
ROCOF df/dt	1	81R	<130 ms	●	●	●
Under-voltage and reactive power, U and Q	2		<250 ms	●	●	
Positive sequence (mains) voltage low	1	27	<60 ms	●	●	
Directional over-current	2	67	<100 ms	●	●	
Negative sequence voltage high	1	47	<400 ms	●	●	
Negative sequence current high	1	46I ₂	<400 ms	●	●	
Zero sequence voltage high	1	59U ₀	<400 ms	●	●	
Zero sequence current high	1	50I ₀	<400 ms	●	●	
Power-dependent reactive power	1	40	-	●		
IEC/IEEE inverse time over-current	1	51	-	●	●	
Neutral inverse time over-current (4th CT)	1	51N	-	●	●	●
Earth fault inverse time over-current (4th CT)	1	51G	-	●	●	●
Neutral over-current (4th CT)	2	-	-	●	●	●
Earth fault over-current (4th CT)	2	-	-	●	●	●

NOTE * See [Generator controller functions](#) for engine protections.

NOTE **You can configure these protections for overload or reverse power.

2. AGC 150 Generator controller

2.1 Display, buttons and LEDs

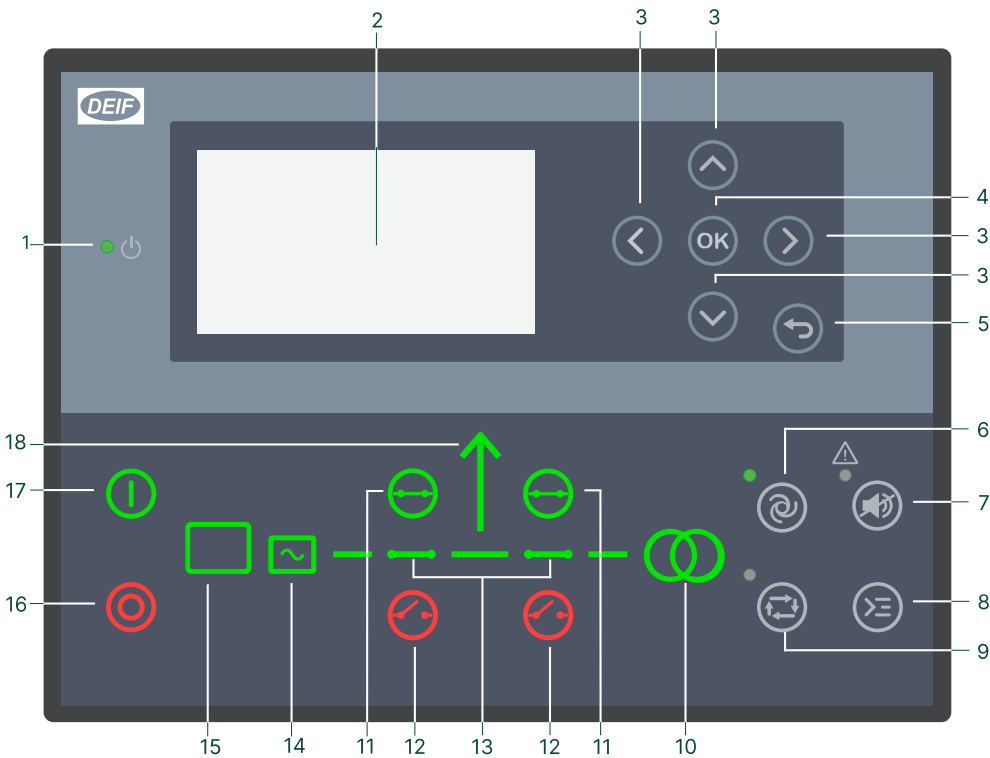

No.	Name	Function
1	Power	Green: The controller power is ON. OFF: The controller power is OFF.
2	Display screen	Resolution: 240 x 128 px. Viewing area: 88.50 x 51.40 mm. Six lines, each with 25 characters.
3	Navigation	Move the selector up, down, left and right on the screen.
4	OK	Go to the Menu system. Confirm the selection on the screen.
5	Back	Go to the previous page.
6	AUTO mode	For generator controllers, the controller automatically starts and stops (and connects and disconnects) gensets. No operator actions are needed. The controllers use the power management configuration to automatically select the power management action.
7	Silence horn	Stops an alarm horn (if configured) and enters the Alarm menu.
8	Shortcut menu	Access the Jump menu, Mode selection, Test, Lamp test.
9	SEMI-AUTO mode	The operator or an external signal can start, stop, connect or disconnect the genset. The generator controller cannot automatically start, stop, connect or disconnect the genset. The controller automatically synchronises before closing a breaker, and automatically deloads before opening a breaker.
10	Mains symbol	Green: Mains voltage and frequency are OK. The controller can synchronise and close the breaker. Red: Mains failure.
11	Close breaker	Push to close the breaker.
12	Open breaker	Push to open the breaker.

No.	Name	Function
13	Breaker symbols	Green: Breaker is closed. Green flashing: Synchronising or deloading. Red: Breaker failure.
14	Generator	Green: Generator voltage and frequency are OK. The controller can synchronise and close the breaker. Green flashing: The generator voltage and frequency are OK, but the V&Hz OK timer is still running. The controller cannot close the breaker. Red: The generator voltage is too low to measure.
15	Engine	Green: There is running feedback. Green flashing: The engine is getting ready. Red: The engine is not running, or there is no running feedback.
16	Stop	Stops the genset if SEMI-AUTO or Manual is selected.
17	Start	Starts the genset if SEMI-AUTO or Manual is selected.
18	Load symbol	OFF: Power management application. Green: The supply voltage and frequency are OK. Red: Supply voltage/frequency failure.

2.2 Typical wiring for generator controller

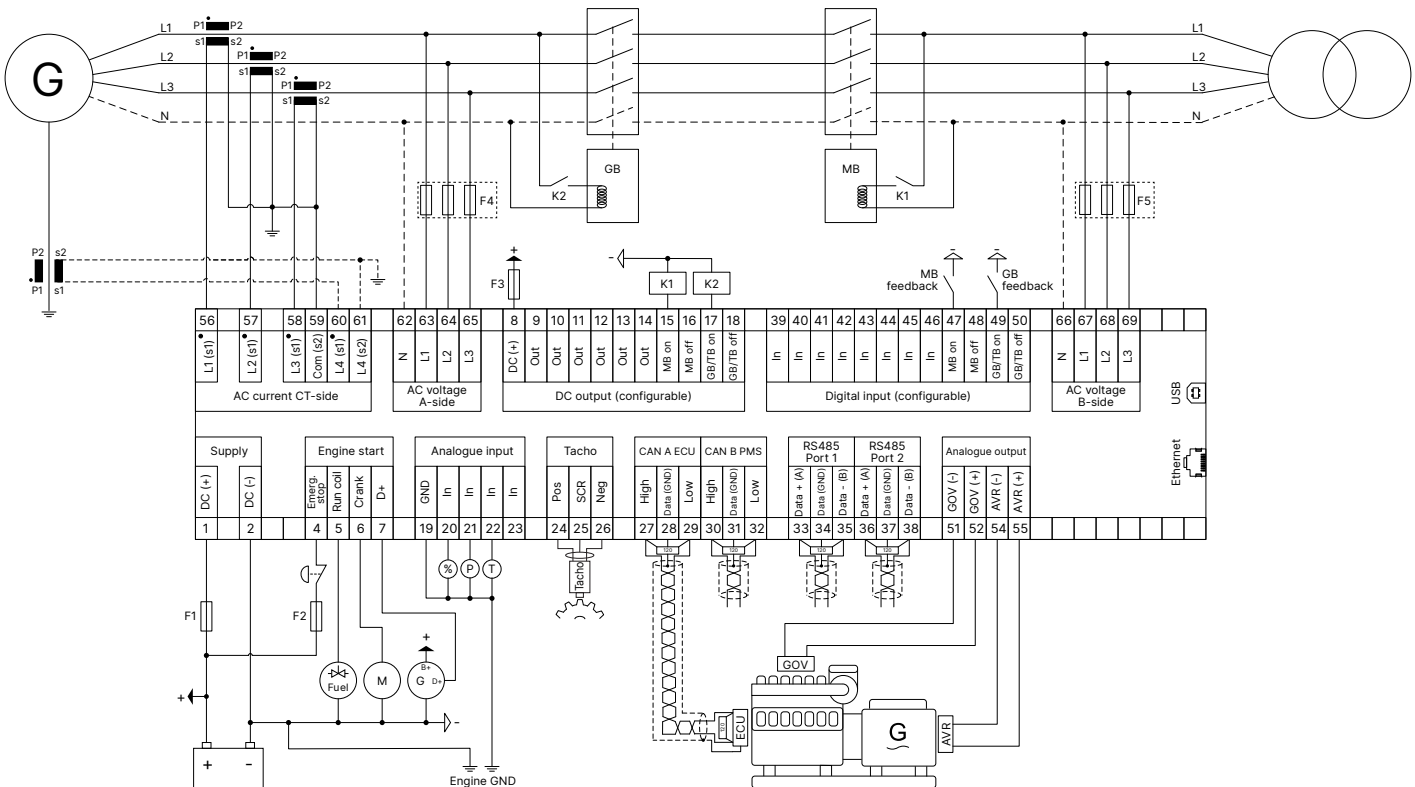

Fuses

- F1: 2 A DC max. time-delay fuse/MCB, c-curve
- F2: 6 A AC max. time-delay fuse/MCB, c-curve
- F3: 4 A DC max. time-delay fuse/MCB, b-curve
- F4, F5: 2 A AC max. time-delay fuse/MCB, c-curve

Grounding guidelines



More information

See **Wiring guidelines - best practice for grounding** in the **Installation instructions**.

2.3 Generator controller functions

Genset functions

Synchronising functions	Core	Extended	Premium
Synchronising (dynamic)	●	●	●
Synchronising (static)		●	●
CBE (run up sync)		●	●
Short-time parallel	●	●	●

Generator functions	Core	Extended	Premium
Built-in analogue AVR control	●	●	●
External analogue AVR control via IOM 230	●	●	●
Digital AVR control: Remote configuration, DVC - DEIF	●	●	●
Digital AVR control: Voltage biasing and remote configuration, DVC 550 - DEIF	●	●	●
Digital AVR control: Voltage biasing, Nidec D550	●	●	●
Digital AVR control: Voltage biasing and remote configuration, Nidec D550			●
Step-up transformer (with phase angle compensation)		●	●
Communication with KWG ISO5 isolation monitor (CAN bus)	●	●	●

Advanced AC protections	Core	Extended	Premium
Vector shift		●	●
ROCOF (df/dt)		●	●
Under-voltage and reactive power, U and Q		●	●
Average busbar over-voltage		●	●
AC directional over-current protection		●	●
Negative sequence current (ANSI 46I ₂)		●	●
Negative sequence voltage (ANSI 47)		●	●
Zero sequence current (ANSI 51I ₀)		●	●
Zero sequence voltage (ANSI 59U ₀)		●	●
Power-dependent reactive power (ANSI 40)		●	●
Inverse time over-current (ANSI 51)		●	●
Grid support (frequency-dependent droop)			●
Ground relay		●	●

4th current transformer measurement	Core	Extended	Premium
High current alarms	2	2	2
High reverse alarms	2	2	2
High power alarms	2	2	2

Additional genset modes	Core	Extended	Premium
Ventilation	●	●	●
Dry alternator	●	●	●

Load sharing	Core	Extended	Premium
Equal load sharing via power management	●	●	●
Analogue load sharing (with IOM 230)	●	●	●
Digital load sharing (CANshare)	●	●	●
3rd party load sharing	●	●	●

Engine functions

Start and stop functions	Core	Extended	Premium
Engine start and stop sequences	●	●	●
Temperature-dependent cooling down	●	●	●
Time-based cooling down	●	●	●
Configurable crank and run coil	●	●	●

Regulation functions	Core	Extended	Premium
Governor regulation using: <ul style="list-style-type: none"> • Engine communication • Built-in analogue control • External analogue control using IOM 230 • Relays 	●	●	●
Manual speed control using: <ul style="list-style-type: none"> • Digital inputs • Display screen menu (by the operator) • Analogue input • Modbus • Configured set point 	●	●	●
Speed sensing using CAN, MPU or frequency	●	●	●
Derate engine		●	●
Ventilation fan control		●	●
Power ramp up and down	●	●	●

Engine protections	Alarms	ANSI	Operate time
Overspeed	2	12	<400 ms
Crank failure	1	48	
Running feedback error	1	34	
MPU wire break	1	-	
Start failure	1	48	
Stop failure	1	-	
Stop coil, wire break alarm	1	-	
Engine heater	1	26	

Engine protections	Alarms	ANSI	Operate time
Max. ventilation/radiator fan	1	-	
Fuel fill check	1	-	
Maintenance alarms	Multiple		

Other engine functions	Core	Extended	Premium
Fuel usage monitoring	●	●	●
Fuel pump logic and refill	●	●	●
Diesel exhaust fluid monitoring	●	●	●
Diesel exhaust fluid logic and refill	●	●	●
Generic fluid monitoring	●	●	●
Generic fluid logic and refill	●	●	●

2.4 Supported controllers and engines

The AGC can communicate with the following ECUs and engines.

Manufacturer	ECU	Engines	Tier 4/Stage V	AGC parameter 7561
Generic J1939	Any ECU that uses J1939	Any engine that uses J1939	●	Generic J1939
ANGLE			-	ANGLE
Baudouin	WOODWARD PG+	-	-	Baudouin Gas
Baudouin	Wise 10B	-	-	Baudouin Wise10B
Baudouin	Wise 15	-	●	Baudouin Wise15
Bosch	EDC17			Bosch EDC17CV54TMTL
Caterpillar	ADEM3	C4.4, C6.6, C9, C15, C18, C32, 3500, 3600	-	Caterpillar ADEM3
Caterpillar	ADEM4		-	Caterpillar ADEM4
Caterpillar	ADEM6		-	Caterpillar ADEM6
Caterpillar	ADEM3, ADEM4	C4.4, C6.6, C9, C15, C18, C32, 3500, 3600	-	Caterpillar Generic*
Catepillar			-	Catepillar with C7.1 AT
Cummins	CM 500	QSL, QSB5, QSX15 and 7, QSM11, QSK 19/23/50/60	-	Cummins CM500
Cummins	CM 558	QSL, QSB5, QSX15 and 7, QSM11, QSK 19/23/50/60	-	Cummins CM558
Cummins	CM 570	QSL, QSB5, QSX15 and 7, QSM11, QSK 19/23/50/60	-	Cummins CM570
Cummins	Cummins CM 570 Industrial		●	Cummins CM570 Industrial
Cummins	CM 850	QSL, QSB5, QSX15 and 7, QSM11, QSK 19/23/50/60	-	Cummins CM850
Cummins	CM 2150	QSL, QSB5, QSX15 and 7, QSM11, QSK 19/23/50/60	●	Cummins CM2150

Manufacturer	ECU	Engines	Tier 4/Stage V	AGC parameter 7561
Cummins	CM 2250	QSL, QSB5, QSX15 and 7, QSM11, QSK 19/23/50/60	●	Cummins CM2250
Cummins	CM 500, CM 558, CM 570, CM 850, CM 2150 and CM 2250	-	ECU-dependent	Cummins Generic*
Cummins	CM 2350		●	Cummins CM2350
Cummins	CM 2350 Industrial		●	Cummins CM2350 Industrial
Cummins	CM 2358		●	Cummins CM2358
Cummins	CM 2850		●	Cummins CM2850
Cummins	CM 2880		●	Cummins CM2880
Cummins	CM 2880 Industrial		●	Cummins CM2880 Industrial
Cummins	-	KTA19	-	Cummins KTA19
Cummins	PGI		●	Cummins PGI
Detroit Diesel	DDEC III	Series 50, 60 and 2000	-	DDEC III
Detroit Diesel	DDEC IV	Series 50, 60 and 2000	-	DDEC IV
Detroit Diesel	DDEC III, DDEC IV	Series 50, 60 and 2000	-	DDEC Generic*
Deutz	EMR2	-	-	Deutz EMR 2
Deutz	EMR3	-	-	Deutz EMR 3
Deutz	EMR 2, EMR 3	-	-	Deutz EMR Generic*
Deutz	EMR4	-	-	Deutz EMR 4
Deutz	EMR5	-	-	Deutz EMR 5
Deutz	EMR4 Stage V	-	●	Deutz EMR 4 Stage V
Deutz	EMR5 Stage V	-	●	Deutz EMR 5 Stage V
Doosan	EDC17	-	-	Doosan G2 EDC17
Doosan	MD1	-	●	Doosan MD1
Doosan	G2 EDC17		●	Doosan stage 5
FPT Industrial	EDC17	-	-	FPT EDC17CV41
FPT Industrial	Bosch MD1	-	●	FPT stage V
Hatz Diesel	-	3/4H50 TICD	●	Hatz
Hatz Diesel	EDC17	-	-	Hatz EDC17
Isuzu	ECM	4JJ1X, 4JJ1T, 6WG1X FT-4	-	Isuzu
Iveco	CURSOR	-	-	Iveco CURSOR
Iveco	EDC7 (Bosch MS6.2),	-	-	Iveco EDC7
Iveco	NEF	-	-	Iveco NEF
Iveco	Iveco NEF67		●	Iveco Stage V NEF67
Iveco	VECTOR 8	-	-	Iveco Vector8
Iveco	CURSOR, NEF, EDC7, VECTOR 8		●**	Iveco Generic*
Iveco				Iveco Generic Industrial
Iveco	Bosch MD1	-	●	Iveco Stage V

Manufacturer	ECU	Engines	Tier 4/Stage V	AGC parameter 7561
JCB	-	ECOMAX DCM3.3+	●	JCB
JCB		P745 & P740 DieselMax Stage V Version 7	●	JCB 430/448 Stage V
Jichai	JC15D-ECU22	-	-	JC15D Weifu***
Jichai	JC15D WYS		-	JC15D WYS
Jichai	JC190		-	JC190
Jichai	JC15T JG		-	Jichai JC15T JG
Jing Guan		Gas	-	Jing Guan
John Deere	JDEC	PowerTech M, E and Plus	●	John Deere
John Deere	FOCUS controls (version 2.1)	-	●	John Deere Stage V
Kohler	ECU2-HD	KD62V12	●	Kohler KD62V12
Kohler	-	KDI 3404	-	Kohler KDI 3404
Kubota	KORD3		●	Kubota Stage V
MAN	EDC17	-		MAN EDC17
MAN	EMC 2.0	-	-	MAN EMC Step 2.0
MAN	EMC 2.5	-	-	MAN EMC Step 2.5
MAN	EMC 2.0 and 2.5	-	-	MAN Generic*
MTU	MDEC, module M.201	-		MDEC 2000/4000 M.201
MTU	MDEC module M.302	Series 2000 and 4000	-	MDEC 2000/4000 M.302
MTU	MDEC module M.303	Series 2000 and 4000	-	MDEC 2000/4000 M.303
MTU	MDEC, module M.304	-		MDEC 2000/4000 M.304
MTU	ADEC	Series 2000 and 4000 (ECU7), MTU PX	-	MTU ADEC
MTU	ADEC, ECU7 without SAM module (software module 501)	Series 2000 and 4000	-	MTU ADEC module 501
MTU	ECU7 with SAM module	-	-	MTU ECU7 with SAM
MTU	ECU8	-	-	MTU ECU8
MTU	ECU9	-	●	MTU ECU9
MTU	J1939 Smart Connect, ECU8, ECU9	Series 1600	● (ECU9 or later)	MTU J1939 Smart Connect
Perkins	ADEM3	-	-	Perkins ADEM3
Perkins	ADEM4	-	-	Perkins ADEM4
Perkins	ADEM3 and ADEM4	Series 850, 1100, 1200, 1300, 2300, 2500 and 2800	-	Perkins Generic*
Perkins	EDC17	-	-	Perkins EDC17C49
Perkins	-	Series 400 and 1200	●	Perkins Stage V
Perkins	-	Series 400 Model IQ IR IW IY IF	●	Perkins StV 400

Manufacturer	ECU	Engines	Tier 4/Stage V	AGC parameter 7561
Perkins	-	Series 1200F Model MT, MU, MV, MW, BM and BN	●	Perkins StV 1200
Perkins	-	Series 1200J Model SU, VM	●	Perkins StV 120xJ (SU/VM)
PSI/Power Solutions	-	PSI/Power Solutions	●	PSI/Power Solutions
QiYao			-	QiYao Gas
Scania	EMS	-	-	Scania EMS
Scania	EMS S6 (KWP2000)	Dx9x, Dx12x, Dx16x	-	Scania EMS 2 S6
Scania	EMS 2 S8	DC9, DC13, DC16	●	Scania EMS 2 S8
Scania	EMS 2 S8	DC9, DC13, DC16	●	Scania S8 Industrial
SDEC	F20		-	SDEC F20
SDEC	F45		-	SDEC F45
Steyr	EDC17	-	-	Steyr EDC17
Volvo Penta	EDC3	-	-	Volvo Penta EDC3
Volvo Penta	EDC4	-	-	Volvo Penta EDC4
Volvo Penta	EDC III, EDC IV	TAD4x, TAD5x, TAD6x, TAD7x	-	Volvo Penta Generic*
Volvo Penta	EMS, EMS 2.0 to EMS2.3	D6, D7, D9, D12, D16 (GE and AUX variants only)	●	Volvo Penta EMS2
Volvo Penta	EMS2.3		●	Volvo Penta EMS2.3
Volvo Penta	EMS2.4	-	●	Volvo Penta EMS 2.4
Weichai	WOODWARD PG+	Diesel	●	Weichai Diesel
Weichai	WOODWARD PG+	Gas	●	Weichai Gas
Weichai	Wise 10B	-	●	Weichai Wise10B
Weichai	Wise 15	-	●	Weichai Wise15
Weichai			-	Weichai Baudouin E6 Gas
Xichai				Xichai Gas
YANMAR	EDC17	-	-	YANMAR EDC17
YANMAR	-	-	-	YANMAR Stage V
Yuchai United	YCGCU (Version 4.2)	Diesel	●	Yuchai United Diesel
Yuchai United	YCGCU (Version 4.2)	Gas	●	Yuchai United Gas
Yuchai United	YC-BCR	-	-	Yuchai YC-BCR
Yuchai United	YC-ECU	-	-	Yuchai YC-ECU

NOTE * Generic protocols are included for backward compatibility.

NOTE ** If supported by the ECU and engine.

NOTE *** Previously *Jichai*

Other EIC protocols: Contact DEIF.



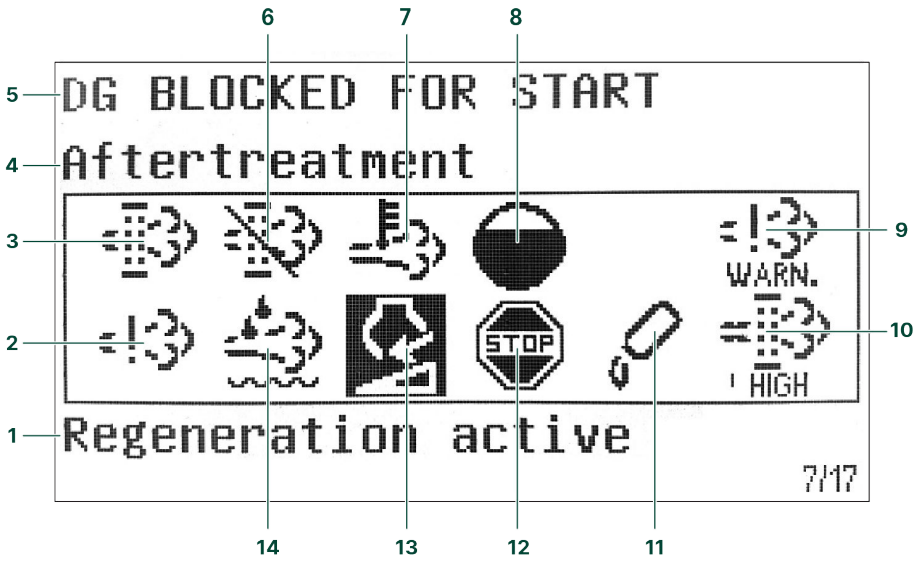

2.5 Exhaust after-treatment (Tier 4/Stage V)

AGC 150 meets the Tier 4 (Final)/Stage V requirements. The user can use the display to monitor (and control) both the engine, and the exhaust after-treatment system.

After-treatment page









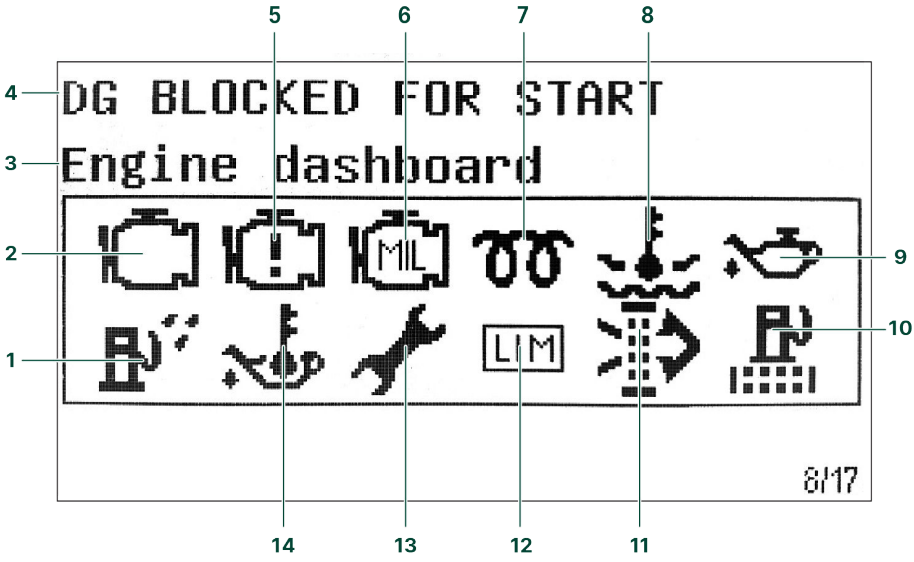





No.	Referent	Symbol	Description
1	After-treatment status	-	
2	Engine emission system failure		Emission failure or malfunction.
3	Diesel Particle Filter (DPF)		Regeneration is needed.
4	Page name	-	
5	Controller status	-	
6	Diesel Particle Filter (DPF) Inhibit		Regeneration is inhibited.
7	High temperature - Regeneration		There is a high temperature and regeneration is in process.
8	HC burn-off		Hydrocarbon accumulation that requires burn-off.
9	Engine emission system failure level	 	Emission failure or malfunction, with the severity.

No.	Referent	Symbol	Description
10	Diesel Particle Filter (DPF) level		Regeneration needed, with the severity.
11	DEF level warning		Low DEF level.
12	DEF shutdown		DEF problem stops normal operation.
13	DEF level inducement		<p>Mid-level inducement.</p> <p>Severe inducement.</p>
14	Diesel Exhaust Fluid (DEF)		DEF quality is low.

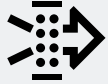
Engine dashboard



No.	Referent	Symbol	Description
1	Water in fuel		There is water in the fuel.
2	Engine interface status		An engine warning.
3	Page name	-	-
4	Controller status	-	-
5	Engine interface status		An engine shutdown.
6	Engine interface status		An engine malfunction.
7	Cold start		The engine is cold.
8	High engine coolant temperature		The engine coolant temperature is high.
9	Low engine oil pressure		The engine oil pressure is low.
10	Fuel filter clogging		The fuel filter is blocked.
11	Air filter clogging		The air filter is blocked.
12	LIMIT lamp		Only for MTU engines.
13	Oil change		The engine needs an oil change.
14	High engine oil temperature		The engine oil temperature is high.

NOTE Grey symbols show that communication is available for the referent. An engine type might not support all of the referents.

3. AGC 150 Mains controller

3.1 Display, buttons and LEDs

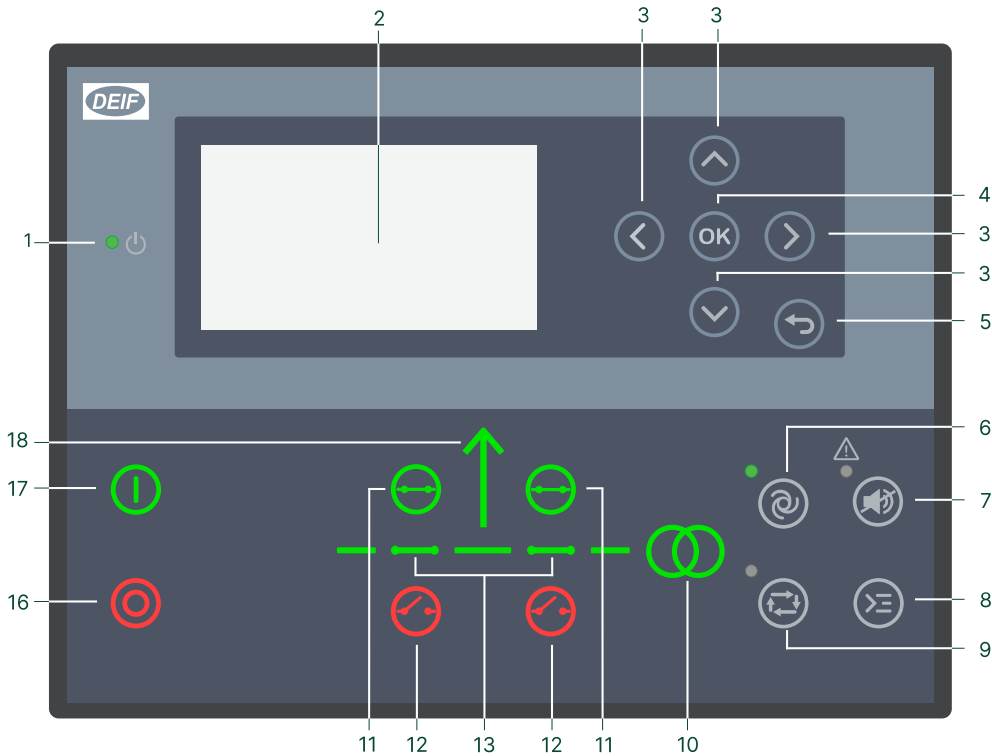

No.	Name	Function
1	Power	Green: The controller power is ON. OFF: The controller power is OFF.
2	Display screen	Resolution: 240 x 128 px. Viewing area: 88.50 x 51.40 mm. Six lines, each with 25 characters.
3	Navigation	Move the selector up, down, left and right on the screen.
4	OK	Go to the Menu system. Confirm the selection on the screen.
5	Back	Go to the previous page.
6	AUTO mode	For mains controllers, the controller automatically connects and disconnects the mains. No operator actions are needed. The controllers use the power management configuration to automatically select the power management action.
7	Silence horn	Stops an alarm horn (if configured) and enters the Alarm menu.
8	Shortcut menu	Access the Jump menu, Mode selection, Test, Lamp test.
9	SEMI-AUTO mode	The operator or an external signal can connect or disconnect the mains. The mains controller cannot automatically connect or disconnect the mains. The controller automatically synchronises before closing a breaker, and automatically deloads before opening a breaker.
10	Mains symbol	Green: Mains voltage and frequency are OK. The controller can synchronise and close the breaker. Red: Mains failure.
11	Close breaker	Push to close the breaker.
12	Open breaker	Push to open the breaker.

No.	Name	Function
13	Breaker symbols	Green: Breaker is closed. Green flashing: Synchronising or deloading. Red: Breaker failure.
16	Stop	Stops the plant.
17	Start	Starts the plant.
18	Load symbol	OFF: Power management application. Green: The supply voltage and frequency are OK. Red: Supply voltage/frequency failure.

3.2 Typical wiring for mains controller

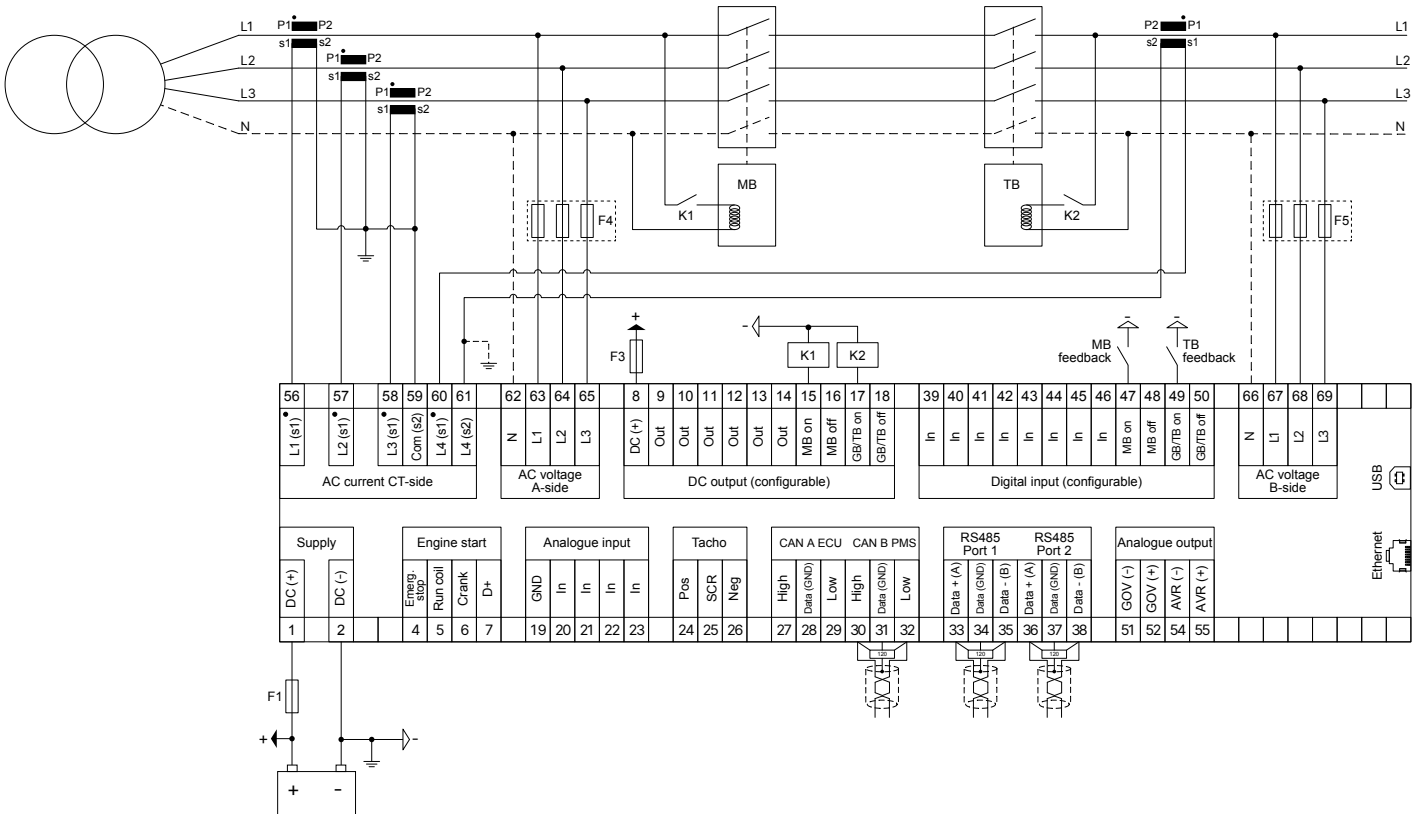

Fuses

- F1: 2 A DC max. time-delay fuse/MCB, c-curve
- F3: 4 A DC max. time-delay fuse/MCB, b-curve
- F4, F5: 2 A AC max. time-delay fuse/MCB, c-curve

3.3 Mains controller functions

Synchronising functions
Synchronising (dynamic)
Synchronising (static)
Short-time parallel between MB and TB

Mains functions

Mains current (3 × true RMS)

Mains/busbar voltage (3-phase/4-wire)

Phase angle compensation generator/busbar/mains synchronising over a transformer

ATS control

Load management

Plant PF control

Mains feeder control, feeders paralleled

Main feeders control, main-tie-main for critical power

4. AGC 150 BTB controller

4.1 Display, buttons and LEDs

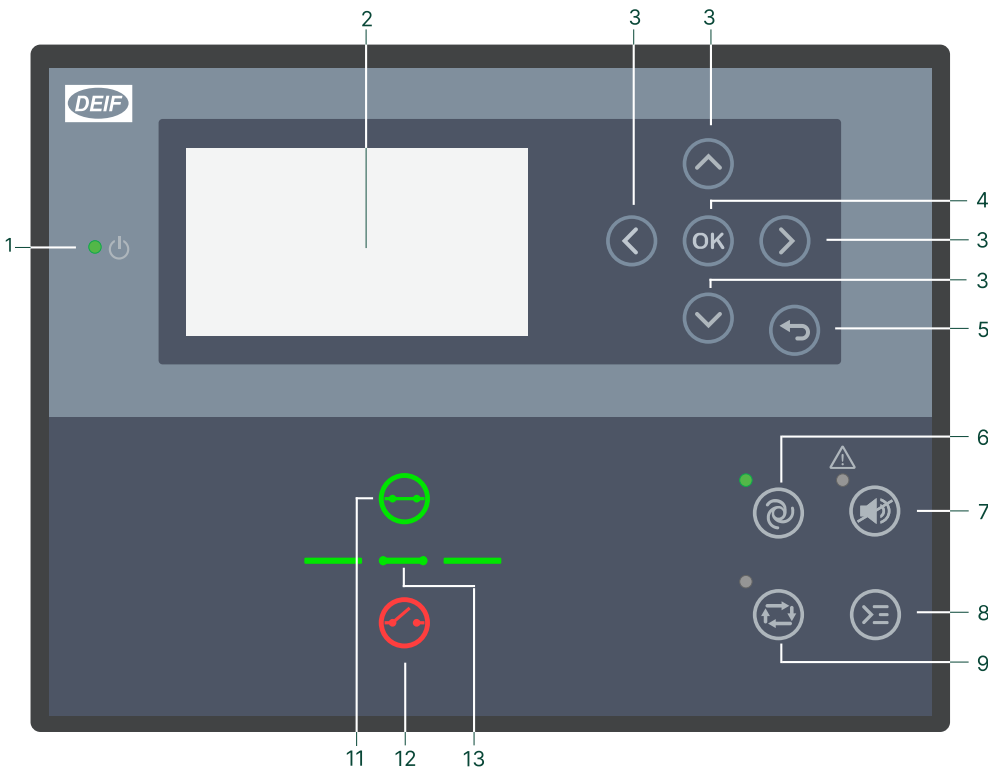

No.	Name	Function
1	Power	Green: The controller power is ON. OFF: The controller power is OFF.
2	Display screen	Resolution: 240 x 128 px. Viewing area: 88.50 x 51.40 mm. Six lines, each with 25 characters.
3	Navigation	Move the selector up, down, left and right on the screen.
4	OK	Go to the Menu system. Confirm the selection on the screen.
5	Back	Go to the previous page.
6	AUTO mode	For BTB controllers, the controller automatically joins and splits the busbar. No operator actions are needed. The controllers use the power management configuration to automatically select the power management action.
7	Silence horn	Stops an alarm horn (if configured) and enters the Alarm menu.
8	Shortcut menu	Access the Jump menu, Lamp test.
9	SEMI-AUTO mode	The operator or an external signal can join or split the busbar. The BTB controller cannot automatically join or split the busbar. The controller automatically synchronises before closing a breaker, and automatically deloads before opening a breaker.
11	Close breaker	Push to close the breaker.
12	Open breaker	Push to open the breaker.
13	Breaker symbols	Green: Breaker is closed. Green flashing: Synchronising or deloading. Red: Breaker failure.

4.2 Typical wiring for BTB controller

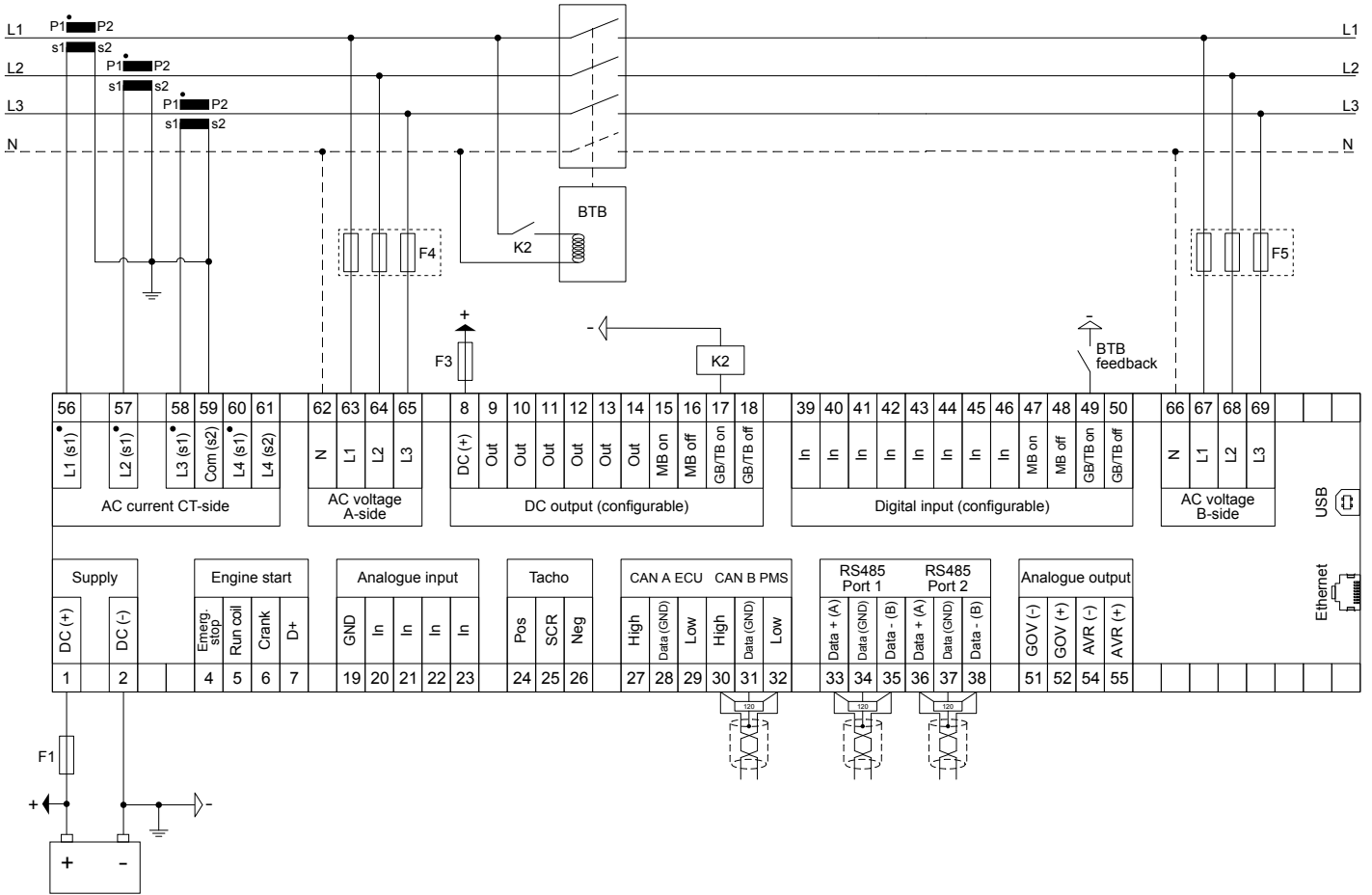

Fuses

- F1: 2 A DC max. time-delay fuse/MCB, c-curve
- F3: 4 A DC max. time-delay fuse/MCB, b-curve
- F4, F5: 2 A AC max. time-delay fuse/MCB, c-curve

4.3 BTB controller functions

BTB controller functions

Synchronising

Section power control

Phase angle compensation generator/busbar/mains synchronising over a transformer

5. Compatible products

5.1 Touch display unit: TDU

TDU is a pre-programmed touch screen display (www.deif.com/products/tdu-series). The TDU can be used for these controllers:

- AGC 150 Generator, Mains and BTB
- ASC 150 Solar and Storage
- AGC-4 Mk II Generator, Mains and BTB
- ASC-4 Solar and Battery
- AGC-4 Generator, Mains and BTB

5.2 Power management

You can use these controllers together in a power management system:

- **AGC 150 Generator** (www.deif.com/products/agc-150-generator)
- **AGC 150 Mains** (www.deif.com/products/agc-150-mains)
- **AGC 150 BTB** (www.deif.com/products/agc-150-btb)
- **ASC 150 Solar** (www.deif.com/products/asc-150-solar)
- **ASC 150 Storage** (www.deif.com/products/asc-150-storage)
- **AGC-4 Mk II Genset, Mains, BTB, Group, and Plant** (www.deif.com/products/agc-4-mk-ii)
- **AGC-4 Genset, Mains, BTB, Group, and Plant** (www.deif.com/products/agc-4)
- **ASC-4 Solar** (www.deif.com/products/asc-4-solar)
- **ASC-4 Battery** (www.deif.com/products/asc-4-battery)
- **ALC-4 (Automatic Load Controller)** (www.deif.com/products/alc-4)

5.3 Open PMS

You can use these controllers together in an open power management system:

- **ASC 150 Solar** (www.deif.com/products/asc-150-solar)
- **ASC 150 Storage** (www.deif.com/products/agc-150-storage)
- **AGC 150 Mains** (www.deif.com/products/agc-150-mains)
- **ASC-4 Solar** (www.deif.com/products/asc-4-solar)
- **ASC-4 Battery** (www.deif.com/products/asc-4-battery)
- **AGC-4 Mk II Mains** (www.deif.com/products/agc-4-mk-ii)

You can also use **AGC 150 Generator**, **AGC-4 Mk II Genset** and/or **AGC-4 Genset** as external gensets. That is, the genset controllers are not part of the open PMS. They can send their power measurements to the open PMS controllers over CAN bus.

5.4 Remote monitoring service: Insight

Insight is a responsive remote monitoring service (www.deif.com/products/insight). It includes real-time genset data, a customisable dashboard, GPS tracking, equipment and user management, email and/or SMS alerts, and cloud data management.

5.5 Digital voltage controllers

DVC 350 is a digital AVR designed for alternators with SHUNT, AREP or PMG excitation. The DVC 350 monitors and regulates the alternator output voltage. AGC 150 can control the DVC 350 features and receive fault information directly with the CAN bus communication. For more information, see www.deif.com/products/dvc-350

DVC 550 is an advanced digital AVR designed for alternators with SHUNT, AREP or PMG excitation. The DVC 550 monitors and regulates the alternator output voltage. AGC 150 can control all the DVC 550 features and receive fault information directly with the CAN bus communication. For more information, see www.deif.com/products/dvc-550

5.6 Additional inputs and outputs

AGC 150 uses CAN bus communication with these:

- **CIO 116** is a remote input expansion module. See www.deif.com/products/cio-116
- **CIO 208** is a remote output expansion module. See www.deif.com/products/cio-208
- **CIO 308** is a remote I/O module. See www.deif.com/products/cio-308
- **IOM 220** and **IOM 230** each have two analogue outputs. These can be used for governor and AVR regulation, or general PID control.

5.7 Additional operator panel, AOP-2

The controller uses CAN bus communication to the additional operator panel (AOP-2). Configure the controller using M-Logic. On the AOP-2, the operator can then:

- Use the buttons to send commands to the controller.
- See LEDs light up to show statuses and/or alarms.

You can configure and connect two AOP-2s if the controller has the premium software package.

5.8 Remote display: AGC 150

The remote display is an AGC 150 that only has a power supply and an Ethernet connection to an AGC 150 controller. The remote display allows the operator to see the controller's operating data, as well as operate the controller remotely.

See www.deif.com/products/agc-150-remote-display

5.9 Shutdown unit, SDU 104

The SDU 104 is a safety device for the protection of engines. The unit keeps the engine running if the main controller fails. The unit can also safely shut down the engine.

See www.deif.com/products/sdu-104

5.10 Other equipment

DEIF has a wide variety of other equipment that is compatible. Here are some examples:

- **Synchrosopes**
 - **CSQ-3** (www.deif.com/products/csq-3)
- **Battery chargers/power supplies**
 - **DBC-1** (www.deif.com/products/dbc-1)
- **Current transformers**
 - **ASK** (www.deif.com/products/ask-asr)
 - **KBU** (www.deif.com/products/kbu)

- **Transducers**
 - **MTR-4** (www.deif.com/products/mtr-4)

5.11 Controller types

Parameter	Setting	Controller type	Minimum software
9101	DG unit	Generator controller	S2
	DG unit	Generator Stand-alone controller	S1
	Mains unit	Mains controller	S2
	BTB unit	BTB controller	S2
	DG HYBRID unit	Genset-Solar hybrid controller	S2
	ENGINE DRIVE unit	Engine drive controller	S1
	Remote unit	Remote display	None
	ENGINE DRIVE MARINE unit	Engine drive controller for marine use	S1
	DG MARINE unit	Stand-alone genset controller for marine use	S1
	ASC 150 Storage*	Battery storage controller	S3
	ASC 150 Solar*	Solar controller	S3
	ATS unit	Automatic transfer switch (open transition)	S1
	ATS unit	Automatic transfer switch (closed transition)	S2
	DG PMS LITE	PMS lite controller	S2

Software packages and controller types

The controller software package determines which functions the controller can use.

- S1 = Stand-alone
 - You can change the controller type to any other controller that uses S1 software.
- S2 = Core
- S3 = Extended
 - You can change the controller type to any other controller type*.
 - * To change to an ASC 150, the controller must have the sustainability option (S10).
- S4 = Premium
 - You can change the controller type to any other controller type*.
 - * To change to an ASC 150, the controller must have the sustainability option (S10).
 - All functions are supported.

You can select the controller type under `Basic settings > Controller settings > Type`.

6. Technical specifications

6.1 Electrical specifications

Power supply

Power supply range	Nominal voltage: 12 V DC or 24 V DC Operating range: 6.5 to 36 V DC
Voltage withstand	Reverse polarity
Power supply drop-out immunity	0 V DC for 50 ms (coming from min. 6 V DC)
Power supply load dump protection	Load dump protected according to ISO16750-2 test A
Power consumption	5 W typical 12 W max.
RTC clock	Time and date backup

Supply voltage monitoring

Measuring range	0 V to 36 V DC Max. continuous operating voltage: 36 V DC
Resolution	0.1 V
Accuracy	± 0.35 V

Voltage measurement

Voltage range	Nominal range: 100 to 690 V phase-to-phase (above 2000 m derate to max. 480 V)
Voltage withstand	$U_n + 35\%$ continuously, $U_n + 45\%$ for 10 seconds Measuring range of nominal: 10 to 135 % Low range, nominal 100 to 260 V: 10 to 351 V AC phase-to-phase High range, nominal 261 to 690 V: 26 to 932 V AC phase-to-phase
Voltage accuracy	$\pm 1\%$ of nominal within 10 to 75 Hz $+1/-4\%$ of nominal within 3.5 to 10 Hz
Frequency range	3.5 to 75 Hz
Frequency accuracy	± 0.01 Hz within 60 to 135 % of nominal voltage ± 0.05 Hz within 10 to 60 % of nominal voltage
Input impedance	4 M Ω /phase-to-ground, and 600 k Ω phase/neutral

Current measurement

Current range	Nominal: -/1 A and -/5 A Range: 2 to 300 %
Number of CT input	4
Max. measured current	3 A (-/1 A) 15 A (-/5 A)
Current withstand	7 A continuous 20 A for 10 seconds 40 A for 1 second
Current accuracy	From 10 to 75 Hz: <ul style="list-style-type: none">$\pm 1\%$ of nominal from 2 to 100% current$\pm 1\%$ of measured current from 100 to 300 % current

Current measurement

	From 3.5 to 10 Hz: <ul style="list-style-type: none">+1/-4 % of nominal from 2 to 100 % current+1/-4 % of measured current from 100 to 300 % current
Burden	Max. 0.5 VA

Power measurement

Accuracy power	±1 % of nominal within 35 to 75 Hz
Accuracy power factor	±1 % of nominal within 35 to 75 Hz

D+

Excitation current	210 mA, 12 V 105 mA, 24 V
Charging fail threshold	6 V

Tacho input

Voltage input range	+/- 1 V _{peak} to 70 V _{peak}
W	8 to 36 V
Frequency input range	10 to 10 kHz (max.)
Frequency measurement tolerance	1 % of reading

Digital inputs

Number of inputs	12 x digital inputs Negative switching
Maximum input voltage	+36 V DC with respect to plant supply negative
Minimum input voltage	-24 V DC with respect to plant supply negative
Current source (contact cleaning)	Initial 10 mA, continuous 2 mA

DC outputs

Number of 3 A outputs	2 x outputs (for fuel and crank) 15 A DC inrush and 3 A continuous, supply voltage 0 to 36 V DC Endurance tested according to UL/ULC6200:2019 1.ed: 24 V, 3 A, 100000 cycles (with an external freewheeling diode)
Number of 0.5 A outputs	10 x outputs 2 A DC inrush and 0.5 A continuous, supply voltage 4.5 to 36 V DC
Common	12/24 V DC

Analogue inputs

Number of inputs	4 x analogue inputs
Electrical range	Configurable as: <ul style="list-style-type: none">Negative switching digital input0 V to 10 V sensor4 mA to 20 mA sensor0 Ω to 2.5 kΩ sensor
Accuracy	Current:

Analogue inputs

- Accuracy: $\pm 20 \text{ uA} \pm 1.00 \% \text{ rdg}$
- Voltage:
- Range: 0 to 10 V DC
 - Accuracy: $\pm 20 \text{ mV} \pm 1.00 \% \text{ rdg}$
- RMI 2-wire LOW:
- Range: 0 to 800 Ω
 - Accuracy: $\pm 2 \Omega \pm 1.00 \% \text{ rdg}$
- RMI 2-wire HIGH:
- Range: 0 to 2500 Ω
 - Accuracy: $\pm 5 \Omega \pm 1.00 \% \text{ rdg}$

Voltage regulator output

Output types	Isolated DC voltage output
Voltage range	-10 to +10 V DC
Resolution in voltage mode	Less than 1 mV
Maximum common mode voltage	$\pm 3 \text{ kV}$
Minimum load in voltage mode	500 Ω
Accuracy	$\pm 1 \% \text{ of setting value}$

Speed governor output

Output types	Isolated DC voltage output Isolated PWM output
Voltage range	-10 to +10 V DC
Resolution in voltage mode	Less than 1 mV
Maximum common mode voltage	$\pm 550 \text{ V}$
Minimum load in voltage mode	500 Ω
PWM frequency range	1 to 2500 Hz $\pm 25 \text{ Hz}$
PWM duty cycle resolution (0-100%)	12 bits (4096 steps)
PWM voltage range	1 to 10.5 V
Voltage accuracy	$\pm 1\% \text{ of setting value}$

Display unit

Type	Graphical display screen (monochrome)
Resolution	240 x 128 pixels
Navigation	Five-key menu navigation
Log book	Data log and trending function
Language	Multi-language display

6.2 Environmental specifications

Operation conditions	
Operating temperature (incl. display screen)	-40 to +70 °C (-40 to +158 °F)
Storage temperature (incl. display screen)	-40 to +85 °C (-40 to +185 °F)
Accuracy and temperature	Temperature coefficient: 0.2 % of full scale per 10 °C
Operating altitude	0 to 4000 m with derating
Operating humidity	Damp Heat Cyclic, 20/55 °C at 97 % relative humidity, 144 hours. To IEC 60255-1 Damp Heat Steady State, 40 °C at 93 % relative humidity, 240 hours. To IEC 60255-1
Change of temperature	70 to -40 °C, 1 °C / minute, 5 cycles. To IEC 60255-1
Protection degree	IEC/EN 60529 <ul style="list-style-type: none"> IP65 (front of module when installed into the control panel with the supplied sealing gasket) IP20 on terminal side
Vibration	Response: <ul style="list-style-type: none"> 10 to 58.1 Hz, 0.15 mmpp 58.1 to 150 Hz, 1 g. To IEC 60255-21-1 (Class 2) Endurance: <ul style="list-style-type: none"> 10 to 150 Hz, 2 g. To IEC 60255-21-1 (Class 2) Seismic vibration: <ul style="list-style-type: none"> 3 to 8.15 Hz, 15 mmpp 8.15 to 35 Hz, 2 g. To IEC 60255-21-3 (Class 2)
Shock	10 g, 11 ms, half sine. To IEC 60255-21-2 Response (Class 2) 30 g, 11 ms, half sine. To IEC 60255-21-2 Withstand (Class 2) 50 g, 11 ms, half sine. To IEC 60068-2-27, test Ea Tested with three impacts in each direction in three axes (total of 18 impacts per test)
Bump	20 g, 16 ms, half sine IEC 60255-21-2 (Class 2) Tested with 1000 impacts in each direction on three axes (total of 6000 impacts per test)
Galvanic separation	CAN port 2 (CAN B): 550 V, 50 Hz, 1 minute RS-485 port 1: 550 V, 50 Hz, 1 minute Ethernet: 550 V, 50 Hz, 1 minute Analogue output 51-52 (GOV): 550 V, 50 Hz, 1 minute Analogue output 54-55 (AVR): 3000 V, 50 Hz, 1 minute Note: No galvanic separation on CAN port 1 (CAN A) and RS-485 port 2
Safety	Installation CAT. III 600 V Pollution degree 2 IEC/EN 60255-27
Flammability	All plastic parts are self-extinguishing to UL94-V0
EMC	IEC/EN 60255-26

6.3 UL/cUL Listed

Requirements	
Installation	To be installed in accordance with the NEC (US) or the CEC (Canada)
Enclosure	A suitable type 1 (flat surface) enclosure is required Unventilated/ventilated with filters for controlled/pollution degree 2 environment
Mounting	Flat surface mounting
Connections	Use 90 °C copper conductors only
Wire size	AWG 30-12
Terminals	Tightening torque: 5-7 lb-in.
Current transformers	Use Listed or Recognized isolating current transformers
Communication circuits	Only connect to communication circuits of a listed system/equipment

6.4 Communication

Communication	
CAN A	<p>You can connect these in a daisy chain (and operate them at the same time):</p> <ul style="list-style-type: none"> • Engine CAN Port • DVC 550 • CIO 116, CIO 208, and CIO 308 • IOM 220 and IOM 230 <p>Data connection 2-wire + common, or 3-wire Not isolated External termination required (120 Ω + matching cable) DEIF engine specification (J1939 + CANopen)</p>
CAN B	<p>You can connect one of these:</p> <ul style="list-style-type: none"> • Power management • CANshare • AOP-2 <p>Data connection 2-wire + common, or 3-wire Isolated External termination required (120 Ω + matching cable) PMS 125 kbit and 250 kbit</p>
RS-485 Port 1	<p>Used for: Modbus RTU, PLC, SCADA, Remote monitoring (Insight)</p> <p>Data connection 2-wire + common, or 3-wire Isolated External termination required (120 Ω + matching cable) 9600 to 115200</p>
RS-485 Port 2	<p>Used for: Modbus RTU, PLC, SCADA, Remote monitoring (Insight)</p> <p>Data connection 2-wire + common, or 3-wire Not isolated External termination required (120 Ω + matching cable) 9600 to 115200</p>
RJ45 Ethernet	<p>Used for:</p> <ul style="list-style-type: none"> • Modbus to PLC, SCADA, and so on • Backup power management system (PMS) communication between AGC 150 controllers • NTP time synchronisation with NTP servers • PC utility software

Communication

	Isolated Auto detecting 10/100 Mbit Ethernet port
USB	Service port (USB-B)

6.5 Approvals

Standards

CE

UL/cUL Listed to UL/ULC6200:2019, 1. ed. controls for stationary engine gensets

NOTE Refer to www.deif.com for the most recent approvals.

6.6 Dimensions and weight

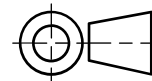
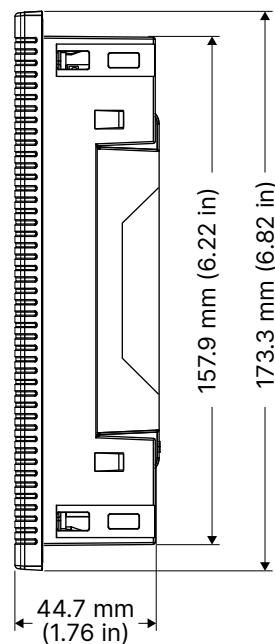
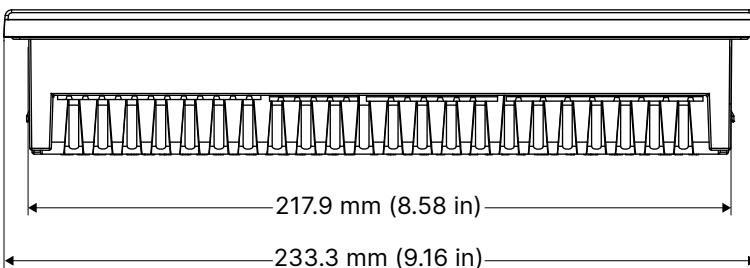
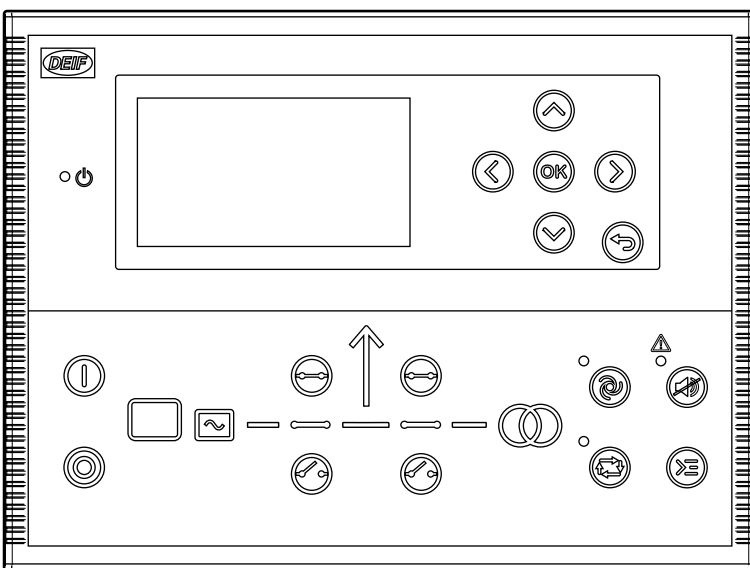

Dimensions and weight

Dimensions	Length: 233.3 mm (9.16 in) Height: 173.3 mm (6.82 in) Depth: 44.7 mm (1.76 in)
Panel cutout	Length: 218.5 mm (8.60 in) Height: 158.5 mm (6.24 in) Tolerance: ± 0.3 mm (0.01 in)
Max. panel thickness	4.5 mm (0.18 in)
Mounting	UL/cUL Listed: Type complete device, open type 1

Dimensions and weight

	UL/cUL Listed: For use on a flat surface of a type 1 enclosure
Weight	0.79 kg

7. Legal information

Disclaimer

DEIF A/S reserves the right to change any of the contents of this document without prior notice.

The English version of this document always contains the most recent and up-to-date information about the product. DEIF does not take responsibility for the accuracy of translations, and translations might not be updated at the same time as the English document. If there is a discrepancy, the English version prevails.

Copyright

© Copyright DEIF A/S. All rights reserved.

7.1 Software version

This document is based on AGC 150 software version 1.20.