

iE 350 PLC

Programmable Automation Controller

Data sheet

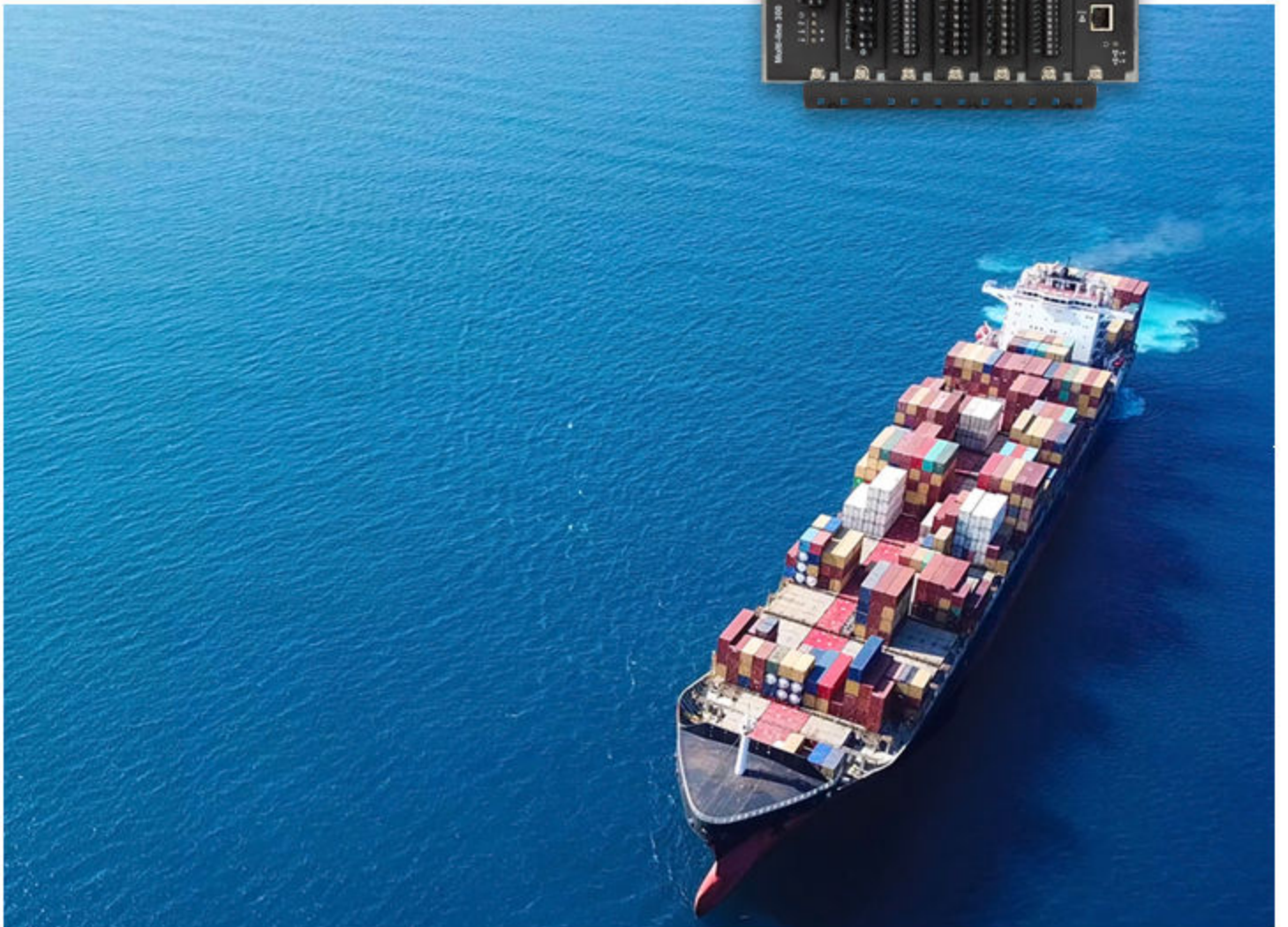
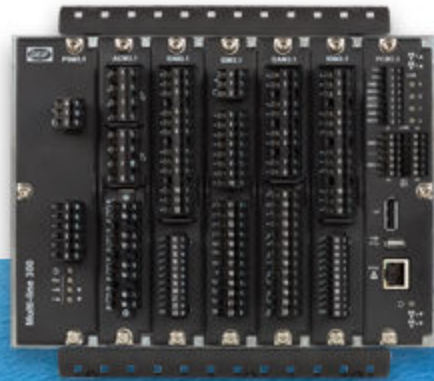

1. Intelligent energy controller

1.1 About the controller	4
1.1.1 About the iE 350 PLC.....	4
1.1.2 About the hardware modules.....	4
1.1.3 Software versions.....	4
1.2 Functions and features	5
1.2.1 General functions and features.....	5
1.3 Applications	6
1.3.1 Applications.....	6
1.3.2 Extension rack functions.....	6
1.4 Compatible products	6
1.4.1 Additional inputs and outputs.....	6
1.4.2 Other equipment.....	8

2. Technical specifications

2.1 Dimensions	9
2.1.1 iE 7 display.....	9
2.1.2 Rack R4.1.....	10
2.1.3 Rack R7.1.....	11
2.2 Mechanical specifications	12
2.2.1 iE 7 display.....	12
2.2.2 Rack R7.1 or R4.1.....	12
2.3 Environmental specifications	14
2.3.1 iE 7 display.....	14
2.3.2 Rack R4.1 and R7.1.....	14
2.4 Hardware modules	15
2.4.1 Power supply module PSM3.1 (Controller).....	15
2.4.2 Power supply module PSM3.2 (Extension).....	16
2.4.3 Alternating current module ACM3.1.....	18
2.4.4 Differential current module ACM3.2.....	19
2.4.5 Engine interface module EIM3.1.....	21
2.4.6 Governor and AVR module GAM3.1.....	23
2.4.7 Governor and AVR module GAM3.2.....	25
2.4.8 Input/output module IOM3.1.....	28
2.4.9 Input/output module IOM3.2.....	29
2.4.10 Input/output module IOM3.3.....	31
2.4.11 Input/output module IOM3.4.....	33
2.4.12 Processor and communication module PCM3.3.....	35
2.4.13 Blind module.....	38
2.4.14 Small blind module.....	38
2.5 Controller or extension racks	38
2.5.1 Rack R4.1.....	38
2.5.2 Rack R7.1.....	38
2.6 iE 7 display	40
2.6.1 Terminal connections.....	40
2.6.2 Electrical specifications.....	40
2.6.3 Communication specifications.....	40
2.7 Accessories	42
2.7.1 USB type A to C cable.....	42
2.7.2 DisplayPort cable.....	42

2.7.3 Ethernet cable.....	42
2.8 Approvals.....	42
2.9 Cybersecurity.....	43
3. Application development	
3.1 IEC61131-3 programming.....	44
3.2 Supported software features.....	44
4. Legal information	
4.1 Disclaimer and copyright.....	46

1. Intelligent energy controller

1.1 About the controller

1.1.1 About the iE 350 PLC

The iE 350 PLC is a highly flexible, modular PLC and I/O system in terms of reliability, robustness and flexibility.

EtherCAT is used as native communication protocol, both for backplane communication, and interconnection between multiple Series 300 racks. Other DEIF EtherCAT I/O modules or third party EtherCAT I/O modules can also be connected.

1.1.2 About the hardware modules

The hardware modules are printed circuit boards that slot in to either a R7.1 or R4.1 rack. Depending on the type of module, they can provide AC or other measurements, inputs, outputs and give communication indication.

Controller racks

R4.1



Modules

- 1 PSM3.1
- 2 module selection
- 1 PCM3.3

R7.1

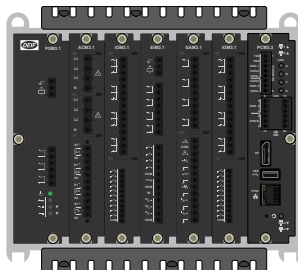

Modules

- 1 PSM3.1
- 5 module selection
- 1 PCM3.3

Extension racks (EtherCAT)

R4.1



Modules

- 1 PSM3.2
- 3 module selection
- 1 small blind module

R7.1

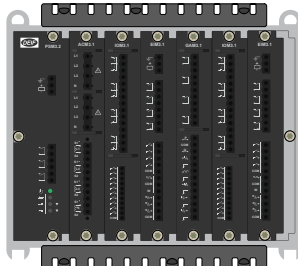

Modules

- 1 PSM3.2
- 6 module selection
- 1 small blind module

The hardware modules feature:

- Placement flexibility in the rack.
- Add, replace, or remove on-site.

All slots must be covered during operation and blind modules can be used to cover unused slots.

1.1.3 Software versions

The information in this document relates to software versions:

Software	Details	Version
iE PLC bundle	Signed Software bundle with components:	2.0.17.x
BSP	Board Support Package (Operating System)	5.0.0.x

Software	Details	Version
CODESYS	CODESYS runtime	3.5.18.40 or later
CODESYS IDE	PC software for development of CODESYS applications	3.5.22.10 or later
CODESYS TSP	iE 350 CODESYS Target Support Package (TSP)	1.3.11.x or later

1.2 Functions and features

1.2.1 General functions and features

Modular and configurable design	
Mounting	<ul style="list-style-type: none"> • iE 350 (Base) Base-mounted • iE 7 display HMI display
New display – easy mount	Display has same cut-out footprint as the DEIF DU 300.
Easy expansion	Range of Series 300 modules and extension racks .

General functions	
CODESYS	CODESYS runtime. View CODESYS license type in WebConfig.
Security	Secure update with signed update packages. Dual partition for safe update. Secure boot - only signed software will run.
DEIF libraries	DEIF OPC UA library for CODESYS - based on open62541.
Application development	CODESYS IDE.

Communication	
Plug and play	Automatic network configuration (uses static IPv6) NTP time synchronisation with NTP servers
Communication	<ul style="list-style-type: none"> • Internet Protocol version 6 (IPv6) with SLAAC • Configurable Internet Protocol version 4 (IPv4)
CAN bus communication	4 CAN ports for: <ul style="list-style-type: none"> • CODESYS J1939 • CANopen CODESYS
RS-485 communication	2 serial ports configurable as client or server
Network	4 port switch and 1 Ethernet port, bridged or standalone

WebConfig	
WebConfig	A browser-based tool to connect to the controller IP address. View controller information. Manage cybersecurity configuration. If required, restart the controller or do a factory reset.

1.3 Applications

1.3.1 Applications

Example PLC application

An example application with the PLC controller connected to 2 extension racks with EtherCAT.

For this application, enable *Redundancy* on the CODESYS EtherCAT master General tab and specify *ETH0* as Network Interface for EtherCAT cable redundancy return channel.

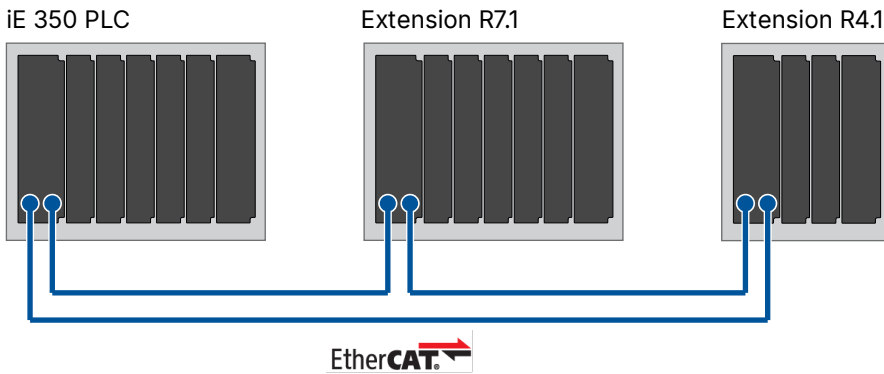

1.3.2 Extension rack functions

	Functions
General	<ul style="list-style-type: none">• Extends I/O interface<ul style="list-style-type: none">◦ 6 additional hardware modules in Rack7.1◦ 3 additional hardware modules in Rack4.1

1.4 Compatible products

1.4.1 Additional inputs and outputs

Series 300 extension modules

You can use the Series 300 extensions racks and range of modules.



More information

See www.deif.com/products/series-300-modules/ for information about all the racks and modules.

Extension racks



Extension rack R4.1

1 PSM3.2
3 module selection

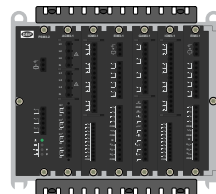

Extension rack R7.1

1 PSM3.2
6 module selection

Modules



IOM3.1 - Input/output module

4 changeover relay outputs
10 digital inputs



IOM3.2 - Input/output module

4 relay outputs
4 analogue multifunctional outputs (including 2 pulse width modulation PWM outputs)
4 digital inputs
4 analogue multifunctional inputs



IOM3.3 - Input/output module

10 analogue multifunctional inputs



IOM3.4 - Input/output module

12 digital outputs
16 digital inputs

iE 650 modules

You can use CODESYS to use modules from iE 650.



More information

See the **iE 650 PLC Data sheet** for details of these modules.

Rack6-4 (4 slots)

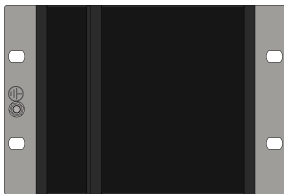

Rack6-14 (14 slots)

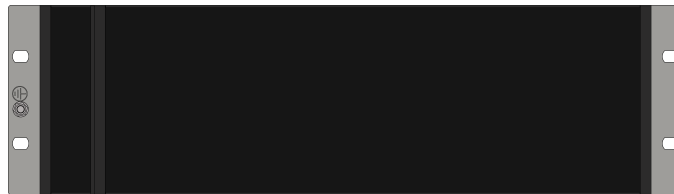

Racks with 6, 8, 10, and 12 slots are also available.

Modules



DIO6-2 - Input/output module

16 digital inputs
16 digital outputs



DIM6-1 - Input module

32 digital inputs



DOM6-1 - Output module

32 digital outputs



AIO6-2 - Input/output module

8 analogue outputs
8 analogue inputs



AOM6-2 - Output module

8 analogue inputs



AIM6-1 - Input module

16 analogue outputs
(Use AIM6-2 if only 8 analogue outputs are required)

1.4.2 Other equipment

DEIF has a wide variety of other equipment that is compatible. This includes synchrosopes, meters, transducers, current transformers, power supplies, and battery chargers.



More information

See www.deif.com

2. Technical specifications

2.1 Dimensions

2.1.1 iE 7 display

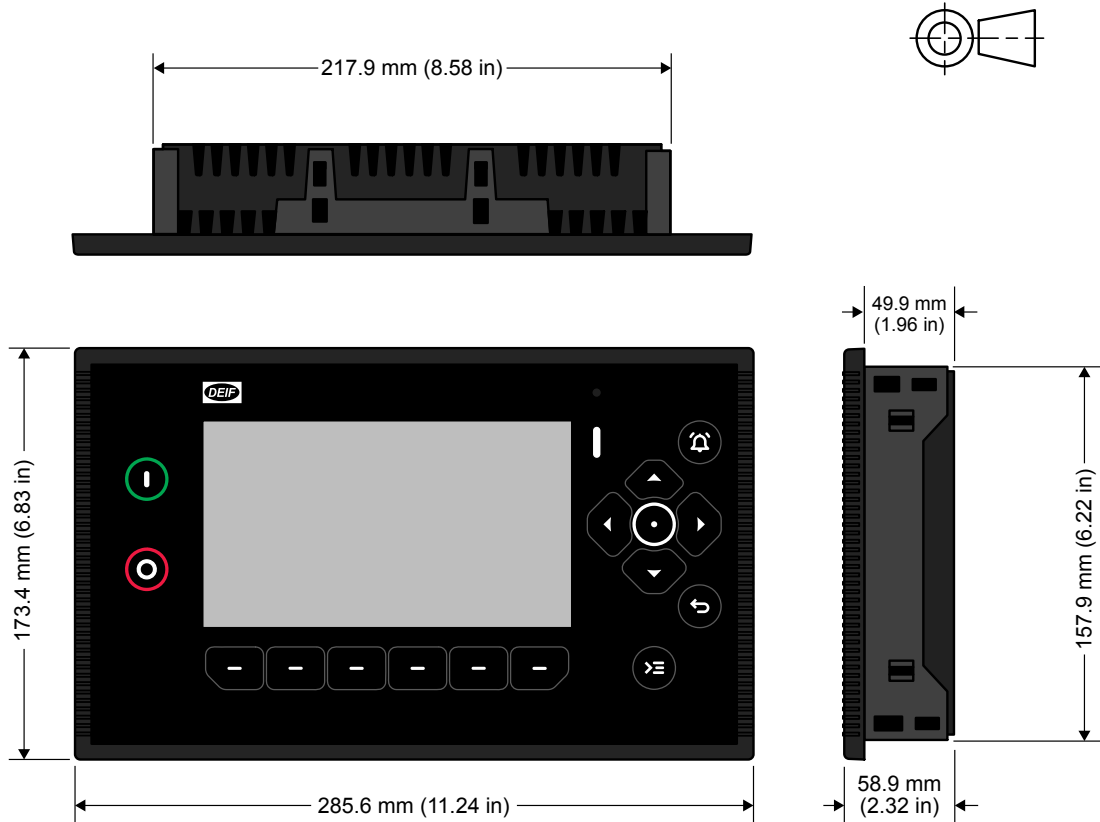

Category	Specifications
Dimensions	L×H×D: 285.6 × 173.4 × 58.9 mm (11.24 × 6.83 × 2.32 in) (outer frame)
Panel cutout	L×H: 220 × 160 mm (8.67 × 6.30 in)
Weight	840 g (1.9 lb)

Category	Specifications
Display	7", Projected Capacitive (PCAP), Touch
Resolution	1024x600 pixels (px)
Brightness	1200 Cd/m ²
Processor	1.6 GHz quad-core industrial grade ARMv8 64 bit CPU with ECC protected cache

2.1.2 Rack R4.1

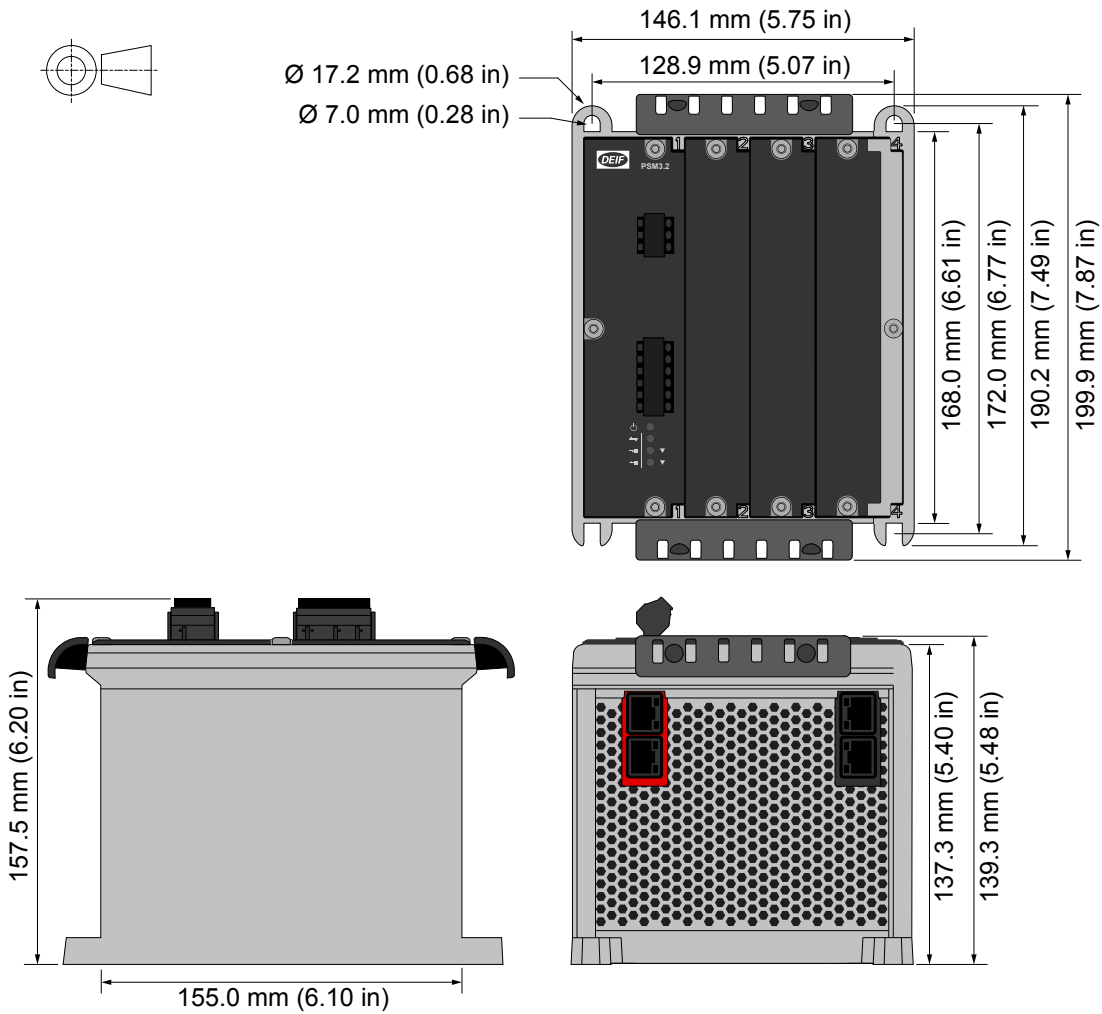

Category	Specification
Dimensions	L 146.1 mm x H 199.9 mm x D 157.5 mm (5.75 in x 7.87 in x 6.20 in) (outer frame, includes cable strain relief plates)
Weight	Without any hardware modules: 994 g (2.2 lb)

2.1.3 Rack R71

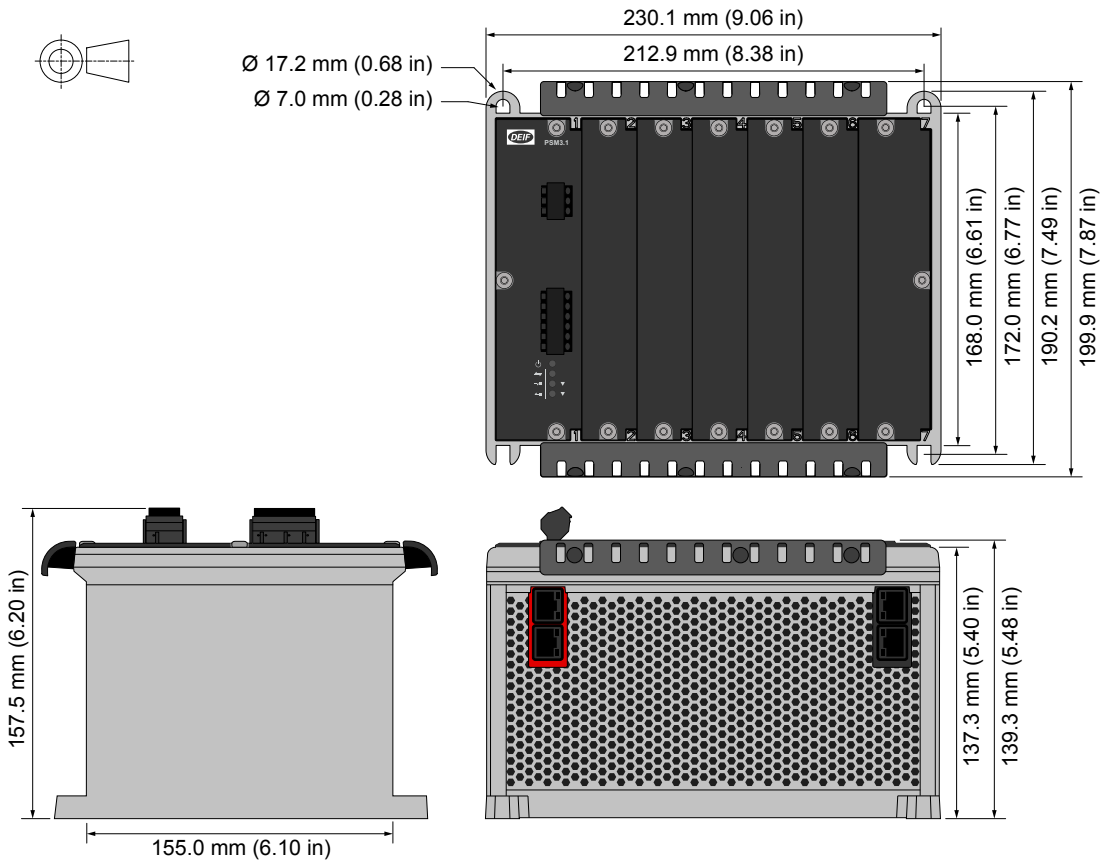

Category	Specification
Dimensions	L 230.1 mm x H 199.9 mm x D 157.5 mm (9.06 in x 7.87 in x 6.20 in) (outer frame, includes cable strain relief plates)
Weight	Without any hardware modules: 1330 g (2.9 lb)

2.2 Mechanical specifications

2.2.1 iE 7 display

Mechanical specifications	
Vibration	Response: <ul style="list-style-type: none"> 10 to 58.1 Hz, 0.15 mmpp 58.1 to 150 Hz, 1 g. To IEC 60255-21-1 (Class 2) Endurance: <ul style="list-style-type: none"> 10 to 150 Hz, 2 g. To IEC 60255-21-1 (Class 2) Seismic vibration: <ul style="list-style-type: none"> 3 to 8.15 Hz, 15 mmpp 8.15 to 35 Hz, 2 g. To IEC 60255-21-3 (Class 2)
Shock	10 g, 11 ms, half sine. To IEC 60255-21-2 Response (Class 2) 30 g, 11 ms, half sine. To IEC 60255-21-2 Withstand (Class 2) 50 g, 11 ms, half sine. To IEC 60068-2-27, test Ea Tested with three impacts in each direction in three axes (total of 18 impacts per test)
Bump	20 g, 16 ms, half sine IEC 60255-21-2 (Class 2) Tested with 1000 impacts in each direction on three axes (total of 6000 impacts per test)
Controller ports without galvanic separation	DisplayPort, USB ports
Safety	Installation CAT. III 600 V Pollution degree 2 IEC 60255-27
Flammability	All plastic parts are self-extinguishing to UL94-V0
EMC	IEC 60255-26

NOTE g = gravitational force (g-force).

2.2.2 Rack R7.1 or R4.1

The general technical specifications apply to all hardware. Refer to the other sections for the specific technical specifications for specific hardware.

The specifications and approvals apply to the rack with all the hardware modules properly installed.

Mechanical specifications		
Vibration	Operation	3 to 8 Hz: 17 mm peak-to-peak 8 to 100 Hz: 4 g 100 to 500 Hz: 2 g
	Response	10 to 58.1 Hz: 0.15 mm peak-to-peak 58.1 to 150 Hz: 1 g
	Endurance	10 to 150 Hz: 2 g
	Seismic	3 to 8.15 Hz: 15 mm peak-to-peak 8.15 to 35 Hz: 2 g
	IEC 60068-2-6, IACS UR E10, IEC 60255-21-1 (class 2), IEC 60255-21-3 (class 2)	

Mechanical specifications

Shock (base-mounted)	10 g, 11 ms, half sine IEC 60255-21-2 Response class 2 30 g, 11 ms, half sine IEC 60255-21-2 Endurance class 2 50 g, 11 ms, half sine IEC 60068-2-27
Bump	20 g, 16 ms, half sine IEC 60255-21-2 class 2
Material	All plastic materials are self-extinguishing according to UL94 (V0)

NOTE g = gravitational force (g-force).

2.3 Environmental specifications

2.3.1 iE 7 display

Environmental specifications	
Operating temperature	-30 to 70 °C (-22 to 158 °F)
Storage temperature	-30 to 80 °C (-22 to 176 °F)
Change of temperature	70 to -30 °C, 1 °C / minute, 5 cycles. To IEC 60255-1
Operating altitude	0 to 4000 m above sea level 2001 to 4000 m: Maximum 480 V AC
Operating humidity	Damp heat cyclic, 20/55 °C at 97 % relative humidity, 144 hours. To IEC 60255-1 Damp heat steady state, 40 °C at 93 % relative humidity, 240 hours. To IEC 60255-1
Protection degree	EN IEC 60529 <ul style="list-style-type: none">• IP65 (front of module when installed into the control panel with the supplied sealing gasket)• IP20 on terminal side

2.3.2 Rack R4.1 and R7.1

Environmental specifications	
Humidity	97 % relative humidity condensing, to IEC 60068-2-30
Operating temperature, rack and modules	-40 to 70 °C (-40 to 158 °F) UL/cUL Listed: maximum surrounding air temperature: 55 °C (131 °F)
Operating temperature, display unit	-20 to 70 °C (-4 to 158 °F) UL/cUL Listed: maximum surrounding air temperature: 55 °C (131 °F)
Storage temperature, rack and modules	-40 to 80 °C (-40 to 176 °F)
Storage temperature, display unit	-30 to 80 °C (-22 to 176 °F)
Operating altitude	Up to 4,000 m (13,123 ft) Refer to the module specifications for information on altitude derating over 2,000 m (6,562 ft)

2.4 Hardware modules











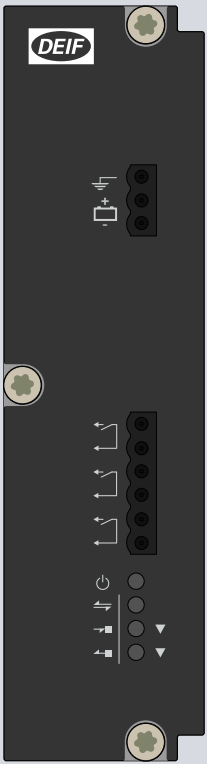

2.4.1 Power supply module PSM3.1 (Controller)

The power supply module provides power to all hardware modules in the rack. The rack status and alarms activate the three relay outputs. There are two ports for internal communication (EtherCAT) only with extension racks.



The PSM3.1 must to be powered by a power supply with Power Boost function.

The PSM3.1 manages the hardware module self-checks for the rack and includes a power LED. The power supply terminals include circuit protection against load dump transients and JEM177 surge transients (rugged design). These terminals also include battery voltage measurement.

PSM3.1 terminals

Module	Count	Symbol	Type/Info	Name
	1		Ground	Frame ground
	1		12 or 24 V	Power supply
	3		Relay output	1 × Status OK (fixed) 2 × configurable
	1		<ul style="list-style-type: none"> ● Off : No power supply  Red flash : PSM is starting or module failure ● Green : Power supply  Green flash : Controller identification 	Power supply indication
	1		<ul style="list-style-type: none"> ● Off : No EtherCAT communication ● Green : EtherCAT Communication 	EtherCAT communication connections (to connect to extension racks).
	1		EtherCAT communication (RJ45) input <ul style="list-style-type: none"> ● Off : No communication ● Green : Communication connected  Green flash : Active communication 	LEDs are on the module front, connections are at the module bottom.
	1		EtherCAT communication (RJ45) output <ul style="list-style-type: none"> ● Off : No communication ● Green : Communication connected  Green flash : Active communication 	

PSM3.1 technical specifications

Category	Specification
Frame ground 	Voltage withstand: ±36 V DC to the power supply positive (terminal 1) and negative (terminal 2)
Controller power supply 	Input voltage: 12 or 24 V DC nominal (8 to 36 V DC continuously) UL/cUL Listed: 10 to 32.5 V DC 0 V DC for 50 ms when coming from at least 8 V DC (cranking dropout) Consumption: Typical 20 W, maximum 35 W Voltage measurement accuracy: 0 to 30 V: ±1 V; 30 to 36 V: +1/-2 V Internal protection: 12 A fuse (not replaceable) (fuse size determined by load dump requirements) Voltage withstand: ±36 V DC Load dump protected by TVS diodes Start current

Category	Specification
	<ul style="list-style-type: none"> Power supply current limiter <ul style="list-style-type: none"> 24 V: 4 A minimum 12 V: 8 A minimum Battery: No limit
Relay outputs 	Relay type: Solid state Electrical rating and UL/cUL Listed: 30 V DC and 1 A, resistive Voltage withstand: ±36 V DC
Terminal connections	Frame ground and power supply: <ul style="list-style-type: none"> Terminals: Standard 45° plug, 2.5 mm² Wiring: 1.5 to 2.5 mm² (16 to 12 AWG), multi-stranded Other connections: <ul style="list-style-type: none"> Terminals: Standard 45° plug, 2.5 mm² Wiring: 0.5 to 2.5 mm² (22 to 12 AWG), multi-stranded
Communication connections	EtherCAT communication: RJ45. Use an Ethernet cable that meets or exceeds the SF/UTP CAT5e specifications
Torques and terminals	Module faceplate screws: 0.5 N·m (4.4 lb-in) Connection of wiring to terminals: 0.5 N·m (4.4 lb-in) UL/cUL Listed: Wiring must be minimum 90 °C (194 °F) copper conductors only
Galvanic isolation	Between power supply and other I/Os: 600 V, 50 Hz for 60 s Between relay groups and other I/Os: 600 V, 50 Hz for 60 s Between internal communication ports and other I/Os: 600 V, 50 Hz for 60 s
Ingress protection	Unmounted: No protection rating Mounted in rack: IP20 according to IEC/EN 60529
Dimensions	L×H×D: 43.3 × 162 × 150 mm (1.5 × 6.4 × 5.9 in)
Weight	331 g (0.7 lb)











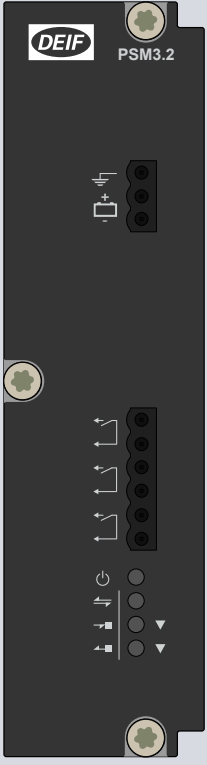

2.4.2 Power supply module PSM3.2 (Extension)

The power supply module provides power to all hardware modules in the extension rack. There are two ports for internal communication with the main controller. The internal communication (EtherCAT) connections are only used to communicate with the main controller. The rack status and alarms activate the three relay outputs.



The PSM3.2 must to be powered by a power supply with Power Boost function.

The PSM3.2 manages the hardware module self-checks for the rack and includes a power LED. The power supply terminals include circuit protection against load dump transients and JEM177 surge transients (rugged design). These terminals also include battery voltage measurement.

PSM3.2 terminals

Module	Count	Symbol	Type/Info	Name
	1		Ground	Frame ground
	1		12 or 24 V	Power supply
	3		Relay output	1 × Status OK (fixed) 2 × configurable
	1		<ul style="list-style-type: none"> ● Off : No power supply  Red flash : PSM is starting or module failure ● Green : Power supply  Green flash : Rack identification 	Power supply indication
	1		<ul style="list-style-type: none"> ● Off : No EtherCAT communication ● Green : EtherCAT Communication 	EtherCAT communication connections (to connect to the racks). LEDs are on the module front, connections are at the module bottom.
	1		EtherCAT communication (RJ45) input <ul style="list-style-type: none"> ● Off : No communication ● Green : Communication connected  Green flash : Active communication 	
	1		EtherCAT communication (RJ45) output <ul style="list-style-type: none"> ● Off : No communication ● Green : Communication connected  Green flash : Active communication 	

PSM3.2 technical specifications

Category	Specification
Frame ground 	Voltage withstand: ±36 V DC to the power supply positive (terminal 1) and negative (terminal 2)
Controller power supply 	Input voltage: 12 or 24 V DC nominal (8 to 36 V DC continuously) UL/cUL Listed: 10 to 32.5 V DC 0 V DC for 50 ms when coming from at least 8 V DC (cranking dropout) Consumption: Typical 20 W, maximum 35 W Voltage measurement accuracy: 0 to 30 V: ±1 V; 30 to 36 V: +1/-2 V Internal protection: 12 A fuse (not replaceable) (fuse size determined by load dump requirements) Voltage withstand: ±36 V DC Load dump protected by TVS diodes Start current <ul style="list-style-type: none"> • Power supply current limiter <ul style="list-style-type: none"> ◦ 24 V: 4 A minimum ◦ 12 V: 8 A minimum • Battery: No limit
Relay outputs 	Relay type: Solid state Electrical rating and UL/cUL Listed: 30 V DC and 1 A, resistive Voltage withstand: ±36 V DC
Terminal connections	Frame ground and power supply: <ul style="list-style-type: none"> • Terminals: Standard 45° plug, 2.5 mm² • Wiring: 1.5 to 2.5 mm² (16 to 12 AWG), multi-stranded Other connections:



Category	Specification
	<ul style="list-style-type: none"> Terminals: Standard 45° plug, 2.5 mm² Wiring: 0.5 to 2.5 mm² (22 to 12 AWG), multi-stranded
Communication connections	EtherCAT communication: RJ45. Use an Ethernet cable that meets or exceeds the SF/UTP CAT5e specifications
Torques and terminals	Module faceplate screws: 0.5 N·m (4.4 lb-in) Connection of wiring to terminals: 0.5 N·m (4.4 lb-in) UL/cUL Listed: Wiring must be minimum 90 °C (194 °F) copper conductors only
Galvanic isolation	Between power supply and other I/Os: 600 V, 50 Hz for 60 s Between relay groups and other I/Os: 600 V, 50 Hz for 60 s Between internal communication ports and other I/Os: 600 V, 50 Hz for 60 s
Ingress protection	Unmounted: No protection rating Mounted in rack: IP20 according to IEC/EN 60529
Dimensions	L×H×D: 43.3 × 162 × 150 mm (1.5 × 6.4 × 5.9 in)
Weight	331 g (0.7 lb)

2.4.3 Alternating current module ACM3.1

The alternating current module ACM3.1 measures the voltage and current on one side of a breaker, and the voltage on the other side. The hardware module responds when the measurements exceed the AC alarm parameters.

ACM3.1 provides robust frequency detection in environments with electrical noise. ACM3.1 allows extended measurement bandwidth up to 40 times the nominal frequency. ACM3.1 includes a configurable 4th current measurement.

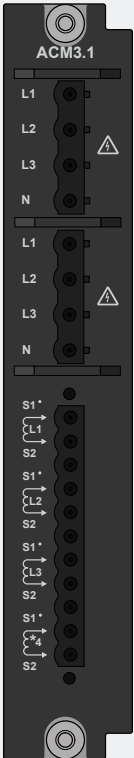
ACM3.1 terminals

Module	Count	Symbol	Type	Name
	2 × (L1, L2, L3 and N)	L1/L2/L3/N	Voltage	3-phase voltage measurements
	1 × (L1, L2, L3 and 4th)		Current	3-phase current measurement



ACM3.1 technical specifications

Category	Specification
Voltage measurements	Nominal value: 100 to 690 V AC phase-to-phase Measurement range: 2 to 897 V AC phase-to-phase Accuracy: Class 0.2 Phase angle accuracy: 0.1° (within nominal voltage range and nominal frequency range) Altitude derating from 2,000 to 4,000 m (6,562 to 13,123 ft): 100 to 480 V AC phase-to-phase UL/cUL Listed: 100 to 600 V AC phase-to-phase Load on external voltage transformer: Maximum 0.2 VA/phase Voltage withstand: 1.2 × Nominal voltage continuously; 1.3 × Nominal voltage for 10 s
Current measurements	Nominal value: 1 or 5 A AC from current transformer Measurement range: 0.02 to 17.5 A AC from current transformer; Truncation level: 11 mA Accuracy: Class 0.2 Earth current: 18 dB attenuation of third harmonic of the nominal frequency UL/cUL Listed: From listed or R/C (XODW2.8) current transformers 1 or 5 A Load on external current transformer: Maximum 0.3 VA/phase Current withstand: 10 A continuously; 17.5 A for 60 s; 100 A for 10 s; 250 A for 1 s
Frequency measurements	Nominal value: 50 Hz or 60 Hz Measurement range: 35 to 78 Hz Accuracy: Class 0.1 of nominal value (35 to 78 Hz) (-40 to 70 °C) (-40 to 158 °F) Class 0.02 of nominal value (40 to 70 Hz) (15 to 30 °C) (59 to 86 °F)
Power measurements	Accuracy: Class 0.5
Accuracy and temperature	Unless otherwise specified for the above measurements: Nominal range: -40 to 70 °C (-40 to 158 °F) Reference range: 15 to 30 °C (59 to 86 °F) Accuracy: Measurement type specific within reference range Additional 0.2 % error of full scale per 10 °C (18 °F) outside reference range
Torques and terminals	Module faceplate screws: 0.5 N·m (4.4 lb-in) Secure the current measurement terminal block to the module faceplate: 0.25 N·m (2.2 lb-in) Connection of wiring to terminals: 0.5 N·m (4.4 lb-in) UL/cUL Listed: Wiring must be minimum 90 °C (194 °F) copper conductors only
Terminal connections	AC voltage and current terminals: Standard 45° plugs, 2.5 mm ² Wiring: 2.5 mm ² (13 AWG), multi-stranded
Galvanic isolation	Between AC voltage and other I/Os: 3310 V, 50 Hz for 60 s Between AC current and other I/Os: 2210 V, 50 Hz for 60 s
Ingress protection	Unmounted: No protection rating Mounted in rack: IP20 according to IEC/EN 60529
Dimensions	L×H×D: 28 × 162 × 150 mm (1.1 × 6.4 × 5.9 in)
Accessories (included)	<ul style="list-style-type: none"> • One roundel with 6 J-shaped voltage encoding pins (for the hardware module) • One roundel with 6 flat voltage encoding pins (for the voltage terminal blocks)
Weight	232 g (0.5 lb)

2.4.4 Differential current module ACM3.2

The differential current module ACM3.2 measures the generator outgoing 3-phase currents (consumer side) and star point 3-phase currents. The ACM3.2 uses the measurements to detect phase-to-phase faults or phase-to-earth faults (star point earthed generator stator only) in the generator stator, and dependent on the mounting of the CT's on the outgoing side, possibly also the cable between the generator and the main switchboard.

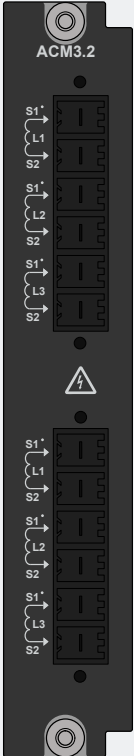
ACM3.2 terminals

Module	Count	Symbol	Type	Name
	1 × (L1, L2 and L3)		Current	3-phase current measurement - Consumer side
	1 × (L1, L2 and L3)		Current	3-phase current measurement - Neutral side

ACM3.2 technical specifications

Category	Specification
Nominal, reference and operating values	<p>Current: Nominal value: 1 or 5 A AC from current transformer</p> <p>Frequency:</p> <ul style="list-style-type: none"> Nominal value: 50 or 60 Hz Reference range: 40 to 70 Hz Operating range: 20 to 78 Hz <p>Temperature:</p> <ul style="list-style-type: none"> Reference range: 15 to 30 °C (59 to 86 °F) Operating range: -40 to 70 °C (-40 to 158 °F)
Current measurements	<p>Measurement range: 0.025 to 250 A AC. Truncation level: 20 mA</p> <p>Accuracy:</p> <ul style="list-style-type: none"> 0.025 to 20 A: ±1 % or ±10 mA of measured current (whichever is greater) 20 to 250 A: ±1.5 % of measured current <p>UL/cUL Listed: From listed or R/C (XODW2.8) current transformers 1 or 5 A</p> <p>Load on external current transformer: < 4 mΩ, including the terminal block</p> <p>Current withstand:</p> <ul style="list-style-type: none"> 20 A continuously 100 A for 10 s 400 A for 1 s 1250 A for 10 ms (half wave)
Frequency measurement	Accuracy (within operating range): > 0.1 A: ±0.1 % of actual frequency
Temperature	Current measurement accuracy temperature coefficient: ±0.25 %, or ±2.5 mA per 10 °C (18 °F) outside reference range (whichever is greater)
Torques and terminals	<p>Module faceplate screws: 0.5 N·m (4.4 lb-in)</p> <p>Secure the current measurement terminal block to the module faceplate: 0.25 N·m (2.2 lb-in)</p> <p>Connection of wiring to terminals:</p>

Category	Specification
	<ul style="list-style-type: none"> ≤ 4 mm²: 0.5 N·m (4.4 lb-in) to 0.6 N·m (5.3 lb-in) > 4 mm²: 0.7 N·m (6.2 lb-in) to 0.8 N·m (7.1 lb-in) UL/cUL Listed: Wiring must be minimum 90 °C (194 °F) copper conductors only
Terminal connections	AC current terminals: Standard 0° plugs, 6 mm ² with securing screws Wiring: 2.5 to 6 mm ² (13 to 10 AWG), multi-stranded
Galvanic isolation	Between AC current and other I/Os: 2210 V, 50 Hz for 60 s
Ingress protection	Unmounted: No protection rating Mounted in rack: IP20 according to IEC/EN 60529
Dimensions	L×H×D: 28 × 162 mm × 152 mm (1.1 × 6.4 × 5.9 in)
Weight	230 g (0.5 lb) (including terminal blocks)
Accessories (included)	One roundel with 6 encoding pins (for the hardware module and terminal block)







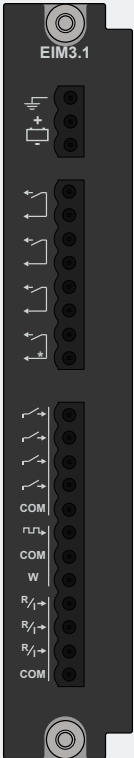

2.4.5 Engine interface module EIM3.1

The engine interface module has its own power supply and a tacho input to measure speed. It also has four relay outputs, four digital inputs, and three analogue inputs. These I/Os are configurable.

The power supply terminals include circuit protection against load dump transients and JEM177 surge transients (rugged design). These terminals also include battery voltage measurement.









EIM3.1 has its own microprocessor. If the rack power supply fails, or connection to the application is lost, the EIM3.1 can continue to operate independent of the application.

EIM3.1 terminals

Module	Count	Symbol	Type	Name	
	1		Ground	Frame ground	
	1		12 or 24 V DC	Power supply	
	3		Relay output	Configurable	
	1		Relay output (with wire break detection)	Configurable	
	4		Digital input	Configurable	
	1		MPU input (with wire break detection)*	Magnetic pickup	
	1		W input (no wire break detection)*	Generator tacho output or NPN/PNP sensor	
	3		Analogue current or resistance measurement input (RMI)	Configurable	

NOTE * These inputs cannot both be used at the same time.

EIM3.1 technical specifications

Category	Specification
Frame ground 	Voltage withstand: ± 36 V DC to the power supply positive (terminal 1) and negative (terminal 2)
Auxiliary power supply 	Input voltage: 12 or 24 V DC nominal (8 to 36 V DC continuously) UL/cUL Listed: 10 to 32.5 V DC 0 V DC for 50 ms when coming from at least 8 V DC (cranking dropout) Consumption: Typical 3 W, maximum 5 W Internal protection: by 12 A fuse (not replaceable) (fuse size determined by load dump requirements) Voltage withstand: ± 36 V DC Load dump protected by TVS diodes Start current <ul style="list-style-type: none"> Power supply current limiter <ul style="list-style-type: none"> 24 V: 0.6 A minimum 12 V: 1.2 A minimum Battery: No limit
Relay outputs 	Relay type: Electromechanical Electrical rating and UL/cUL Listed: 30 V DC and 6 A, resistive Voltage withstand: ± 36 V DC
Relay output with wire break detection 	Relay type: Electromechanical Electrical rating and UL/cUL Listed: 30 V DC and 6 A, resistive Includes wire break detection Voltage withstand: ± 36 V DC
Magnetic pickup 	Voltage: 3 to 70 V AC peak Frequency: 2 to 20,000 Hz Accuracy: 2 to 99 Hz: 0.5 Hz; 100 to 20,000 Hz: ± 0.5 % of measurement Cable supervision: Resistance maximum 100 k Ω Includes wire break detection Voltage withstand: 70 V AC
Generator tacho (W) 	Voltage: 8 to 36 V DC Frequency: 2 to 20,000 Hz Accuracy: 2 to 99 Hz: 0.5 Hz; 100 to 20,000 Hz: ± 0.5 % of measurement No wire break detection Voltage withstand: ± 36 V DC
NPN/PNP 	Voltage: 8 to 36 V DC Frequency: 2 to 20,000 Hz Accuracy: 2 to 99 Hz: 0.5 Hz; 100 to 20,000 Hz: ± 0.5 % of measurement No wire break detection Voltage withstand: ± 36 V DC
Digital inputs 	Bipolar inputs <ul style="list-style-type: none"> ON: -36 to -8 V DC, and 8 to 36 V DC OFF: -2 to 2 V DC Minimum pulse length: 50 ms Impedance: 4.7 k Ω Voltage withstand: ± 36 V DC
Analogue multi-functional inputs 	Current input <ul style="list-style-type: none"> From active transmitter: 0 to 20 mA, 4 to 20 mA, or any custom range between 0 and 25 mA Accuracy: 1 % of selected range Pt100/1000 <ul style="list-style-type: none"> -40 to 250 °C (-40 to 482 °F)







Category	Specification
	<ul style="list-style-type: none"> Accuracy: 1 % of full scale (to IEC/EN60751) Maximum sensor self-heating: 0.5 °C/mW (1 °F/mW) <p>Resistance measurement</p> <ul style="list-style-type: none"> Any custom range between 0 and 2.5 kΩ Accuracy: 1 % over ranges: 0 to 200 Ω, 0 to 300 Ω, 0 to 500 Ω, 0 to 1000 Ω, and 0 to 2500 Ω <p>Digital input</p> <ul style="list-style-type: none"> Dry contact with cable supervision Maximum circuit resistance: 330 Ω Minimum current rating for the connected relay: 2.5 mA <p>Voltage withstand: ±36 V DC All analogue multi-functional inputs for EIM3.1 have a common ground</p>
Terminal connections	<p>Frame ground and power supply</p> <ul style="list-style-type: none"> Terminals: Standard 45° plug, 2.5 mm² Wiring: 1.5 to 2.5 mm² (16 to 12 AWG), multi-stranded <p>Other connections</p> <ul style="list-style-type: none"> Terminals: Standard 45° plug, 2.5 mm² Wiring: 0.5 to 2.5 mm² (22 to 12 AWG), multi-stranded
Torques and terminals	<p>Module faceplate screws: 0.5 N·m (4.4 lb-in) Connection of wiring to terminals: 0.5 N·m (4.4 lb-in) UL/cUL Listed: Wiring must be minimum 90 °C (194 °F) copper conductors only</p>
Galvanic isolation	<p>Between relay groups and other I/Os: 600 V, 50 Hz for 60 s Between digital input groups and other I/Os: 600 V, 50 Hz for 60 s Between MPU and W inputs and other I/Os: 600 V, 50 Hz for 60 s Between analogue inputs and other I/Os: 600 V, 50 Hz for 60 s</p>
Ingress protection	<p>Unmounted: No protection rating Mounted in rack: IP20 according to IEC/EN 60529</p>
Dimensions	L×H×D: 28 × 162 × 150 mm (1.1 × 6.4 × 5.9 in)
Weight	250 g (0.5 lb)

2.4.6 Governor and AVR module GAM3.1

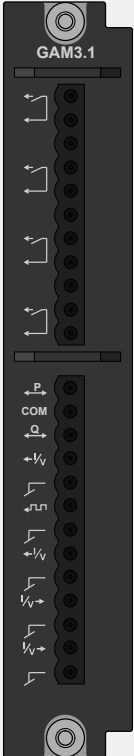



This governor and AVR module has four relay outputs, two analogue outputs and a pulse width modulation output, and two analogue inputs. These I/Os are configurable.

GAM3.1 also has terminals for analogue load sharing (future use).

GAM3.1 terminals

Module	Count	Symbol	Type	Name
	4		Relay output	Configurable
	1		Load sharing	Active power (P) (kW) load sharing (future use)
	1		Load sharing	Reactive power (Q) (kvar) sharing (future use)
	2		Analogue current or voltage output	GOV/AVR/configurable
	1		Pulse width modulation (PWM) output	PWM output (with PWM ground)
	2		Analogue current or voltage input	Configurable

GAM3.1 technical specifications

Category	Specification
Relay outputs 	Relay type: Electromechanical Electrical rating and UL/cUL Listed: 250 V AC or 30 V DC, and 6 A, resistive; B300, pilot duty (B300 is a power limit specification for inductive loads) Altitude derating from 2,000 to 4,000 m (6,562 to 13,123 ft): Maximum 150 V AC phase-to-phase Voltage withstand: 250 V AC
Load sharing (future use)  	Voltage input/output: -5 to 5 V DC Impedance: 23.5 k Ω Accuracy: 1 % of full scale, for both inputs and outputs Voltage withstand: ± 36 V DC
Analogue multi-functional outputs 	Current output <ul style="list-style-type: none"> -20 to 20 mA, or 0 to 20 mA, or 4 to 20 mA, or any custom range between -25 and 25 mA Accuracy: 1 % of the selected range (minimum range: 5 mA) 16-bit resolution over the range -25 to 25 mA Active output (internal supply) Maximum load: 400 Ω Voltage output (DC) <ul style="list-style-type: none"> -10 to 10 V, 0 to 10 V, 0 to 5 V, -5 to 5 V, 0 to 3 V, -3 to 3 V, or 0 to 1 V, or any custom range between -10 and 10 V Accuracy: 1 % of the selected range (minimum range: 1 V) 16-bit resolution over the range -10 to 10 V Minimum load: 600 Ω. Voltage output internal resistance: < 1 Ω Voltage withstand: ± 36 V DC Controller power off: Internal resistance > 10 M Ω







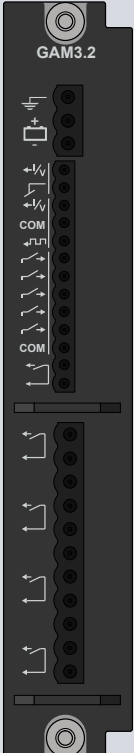

Category	Specification
Pulse width modulation (PWM) output ↔	<p>Frequency: 500 Hz ±50 Hz Resolution: 43,200 levels Voltage:</p> <ul style="list-style-type: none"> • Low level: < 0.5 V • High level: > 5.5 V • Maximum: 6.85 V <p>Output impedance: 100 Ω Nominal temperature range: -40 to 70 °C (-40 to 158 °F) Reference temperature range: 15 to 30 °C (59 to 86 °F) Duty cycle accuracy (5 to 95 %): 0.25 % within reference temperature range 0.2 % of full scale additional error per 10 °C (18 °F) outside the reference range Example: At 70 °C (158 °F) the accuracy of the PWM output is 0.25 % + 4 × 0.2 % = 1.05 % Voltage withstand: ±30 V DC</p>
Analogue multi-functional inputs ↕	<p>Current inputs</p> <ul style="list-style-type: none"> • From active transmitter: 0 to 20 mA, 4 to 20 mA, or any custom range between 0 and 24 mA • Accuracy: 1 % of selected range <p>Voltage inputs (DC)</p> <ul style="list-style-type: none"> • -10 to 10 V, 0 to 10 V, or any custom range between -10 and 10 V • Accuracy: 1 % of selected range <p>Voltage withstand: ±36 V DC</p>
Terminal connections	<p>Terminals: Standard 45° plug, 2.5 mm² Wiring: 0.5 to 2.5 mm² (22 to 12 AWG), multi-stranded</p>
Torques and terminals	<p>Module faceplate screws: 0.5 N·m (4.4 lb-in) Connection of wiring to terminals: 0.5 N·m (4.4 lb-in) UL/cUL Listed: Wiring must be minimum 90 °C (194 °F) copper conductors only</p>
Galvanic isolation	<p>Between individual relays and other I/Os: 2210 V, 50 Hz for 60 s Between load sharing and other I/Os: 600 V, 50 Hz for 60 s Between terminals 12 to 15 (analogue output 1, PWM output), and other I/Os: 600 V, 50 Hz for 60 s</p> <ul style="list-style-type: none"> • Analogue output 1 and the PWM output are galvanically connected <p>Between terminals 16, 17 (analogue output 2) and other I/Os: 600 V, 50 Hz for 60 s Between terminals 18 to 21 (analogue inputs) and other I/Os: 600 V, 50 Hz for 60 s</p> <ul style="list-style-type: none"> • Analogue inputs 1 and 2 are galvanically connected
Ingress protection	<p>Unmounted: No protection rating Mounted in rack: IP20 according to IEC/EN 60529</p>
Dimensions	L×H×D: 28 × 162 × 150 mm (1.1 × 6.4 × 5.9 in)
Weight	224 g (0.5 lb)

2.4.7 Governor and AVR module GAM3.2



This governor and AVR module has its own power supply, two analogue outputs and a pulse width modulation output, five digital inputs, a status relay output, and four relay outputs. Apart from the status relay, all these I/Os are configurable.





GAM3.2 has its own microprocessor. If the rack power supply fails, GAM3.2 can continue to be used for manual operation if it has its own, independent power supply. The power supply terminals include circuit protection against load dump transients and JEM177 surge transients (rugged design). These terminals also include battery voltage measurement.

GAM3.2 terminals

Module	Count	Symbol	Type	Name
	1		Ground	Frame ground
	1		12 or 24 V	Power supply
	2		Analogue current or voltage output	GOV/AVR/configurable
	1		Pulse width modulation (PWM) output	PWM output
	5		Digital input	Configurable
	1		Relay output	GAM3.2 status
	4		Relay output	Configurable

GAM3.2 technical specifications

Category	Specification
Auxiliary power supply 	<p>Input voltage: 12 or 24 V DC nominal (8 to 36 V DC continuously) UL/cUL Listed: 10 to 32.5 V DC 0 V DC for 50 ms when coming from at least 8 V DC (cranking dropout) Consumption: Typical 3 W, maximum 5 W Voltage measurement accuracy: ± 0.1 V (measurement range 8 to 36 V DC) Internally protection: 12 A fuse (not replaceable) (fuse size determined by load dump requirements) Voltage withstand: ± 36 V DC Load dump protected by TVS diodes</p> <p>Start current</p> <ul style="list-style-type: none"> Power supply current limiter <ul style="list-style-type: none"> 24 V: 0.6 A minimum 12 V: 1.2 A minimum Battery: No limit
Analogue multi-functional outputs 	<p>Current output</p> <ul style="list-style-type: none"> Any custom range between -25 and 25 mA Accuracy: 1 % of the selected range (minimum range: 5 mA) 16-bit resolution Active output (internal supply) Maximum load: 400 Ω <p>Voltage output (DC)</p> <ul style="list-style-type: none"> Any custom range between -10 and 10 V Accuracy: 1 % of the selected range (minimum range: 1 V) 16-bit resolution Minimum load: 600 Ω. Voltage output internal resistance: < 1 Ω.



Category	Specification
	Voltage withstand: ± 36 V DC Controller power off: Internal resistance > 10 M Ω
Pulse width modulation (PWM) output 	Frequency: 500 Hz ± 50 Hz Resolution: 43,200 levels Voltage: <ul style="list-style-type: none"> Low level: < 0.5 V High level: > 5.5 V Maximum: 6.85 V Output impedance: 100 Ω Nominal temperature range: -40 to 70 $^{\circ}\text{C}$ (-40 to 158 $^{\circ}\text{F}$) Reference temperature range: 15 to 30 $^{\circ}\text{C}$ (59 to 86 $^{\circ}\text{F}$) Duty cycle accuracy (5 to 95 %): 0.25 % within reference temperature range 0.2 % of full scale additional error per 10 $^{\circ}\text{C}$ (18 $^{\circ}\text{F}$) outside the reference range Example: At 70 $^{\circ}\text{C}$ (158 $^{\circ}\text{F}$) the accuracy of the PWM output is $0.25\% + 4 \times 0.2\% = 1.05\%$ Voltage withstand: ± 30 V DC
Digital inputs 	Bipolar inputs <ul style="list-style-type: none"> ON: -36 to -8 V DC, and 8 to 36 V DC OFF: -2 to 2 V DC Minimum pulse length: 50 ms Impedance: 4.7 k Ω Voltage withstand: ± 36 V DC
Relay output (GAM3.2 status) 	Relay type: Solid state Electrical rating and UL/cUL Listed: 30 V DC and 1 A, resistive Voltage withstand: ± 36 V DC
Relay outputs 	Relay type: Electromechanical Electrical rating and UL/cUL Listed: 250 V AC or 30 V DC, and 6 A, resistive; B300, pilot duty (B300 is a power limit specification for inductive loads) Altitude derating from 2,000 to 4,000 m (6,562 to 13,123 ft): Maximum 150 V AC phase-to-phase Voltage withstand: 250 V AC
Terminal connections	Frame ground and power supply <ul style="list-style-type: none"> Terminals: Standard 45$^{\circ}$ plug, 2.5 mm2 Wiring: 1.5 to 2.5 mm2 (16 to 12 AWG), multi-stranded Analogue inputs, PWM, digital inputs and the status relay <ul style="list-style-type: none"> Terminals: Standard 45$^{\circ}$ plug, 1.5 mm2 Wiring: 0.5 to 1.5 mm2 (28 to 16 AWG), multi-stranded Relay outputs <ul style="list-style-type: none"> Terminals: Standard 45$^{\circ}$ plug, 2.5 mm2 Wiring: 0.5 to 2.5 mm2 (22 to 12 AWG), multi-stranded
Torques and terminals	Module faceplate screws: 0.5 N·m (4.4 lb-in) Connection of wiring to frame ground and power supply terminals: 0.5 N·m (4.4 lb-in) Connection of wiring to analogue inputs, PWM, digital inputs, and the status relay terminals: 0.25 N·m (2.2 lb-in) Connection of wiring to relay output terminals: 0.5 N·m (4.4 lb-in) UL/cUL Listed: Wiring must be minimum 90 $^{\circ}\text{C}$ (194 $^{\circ}\text{F}$) copper conductors only
Galvanic isolation	Between power supply and other I/Os: 600 V, 50 Hz for 60 s Between analogue inputs, PWM, digital inputs, and the status relay, and other I/Os: 600 V, 50 Hz for 60 s The analogue output on terminals 5 and 6 is galvanically connected to the PWM output (terminals 6 and 7) Between relay groups and other I/Os: 2210 V, 50 Hz for 60 s
Ingress protection	Unmounted: No protection rating

Category	Specification
	Mounted in rack: IP20 according to IEC/EN 60529
Dimensions	L×H×D: 28 × 162 × 150 mm (1.1 × 6.4 × 5.9 in)
Weight	246 g (0.5 lb)

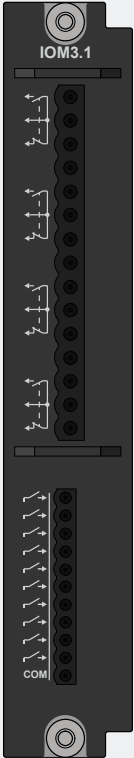

2.4.8 Input/output module IOM3.1

The input output module has 4 changeover relay outputs, and 10 digital inputs. These I/Os are all configurable.

IOM3.1 terminals

Module	Count	Symbol	Type	Name
	4		Relay output	Configurable
	10		Digital input	Configurable

IOM3.1 technical specifications

Category	Specification
Relay outputs 	Relay type: Electromechanical Electrical rating and UL/cUL Listed: 250 V AC or 30 V DC, and 6 A, resistive; B300, pilot duty (B300 is a power limit specification for inductive loads) Altitude derating from 3,000 to 4,000 m (9,842 to 13,123 ft): Maximum 150 V AC phase-to-phase Voltage withstand: 250 V AC
Digital inputs 	Bipolar inputs <ul style="list-style-type: none"> ON: -36 to -8 V DC, and 8 to 36 V DC OFF: -2 to 2 V DC Minimum pulse length: 50 ms Impedance: 4.7 kΩ Voltage withstand: ±36 V DC
Terminal connections	Relay outputs: Terminals: Standard 45° plug, 2.5 mm ² Wiring: 0.5 to 2.5 mm ² (22 to 12 AWG), multi-stranded Digital inputs: Terminals: Standard 45° plug, 1.5 mm ² Wiring: 0.1 to 1.5 mm ² (28 to 16 AWG), multi-stranded







Category	Specification
Torques and terminals	Module faceplate screws: 0.5 N·m (4.4 lb-in) Connection of wiring to relay output terminals: 0.5 N·m (4.4 lb-in) Connection of wiring to digital input terminals: 0.25 N·m (2.2 lb-in) UL/cUL Listed: Wiring must be minimum 90 °C (194 °F) copper conductors only
Galvanic isolation	Between relay groups and other I/Os: 2210 V, 50 Hz for 60 s Between digital input groups and other I/Os: 600 V, 50 Hz for 60 s
Ingress protection	Unmounted: No protection rating Mounted in rack: IP20 according to IEC/EN 60529
Dimensions	L×H×D: 28 × 162 × 150 mm (1.1 × 6.4 × 5.9 in)
Weight	196 g (0.4 lb)

2.4.9 Input/output module IOM3.2

The input output module has 4 relay outputs, 4 analogue multifunctional outputs (including 2 pulse width modulation PWM outputs), 4 digital inputs, and 4 analogue multifunctional inputs. These I/Os are all configurable.



Internal cold junction compensation is not available on IOM3.2

IOM3.2 terminals

Module	Count	Symbol	Type	Name
	4		Relay output	Configurable
	2		Analogue multifunctional output (mA, V DC, PWM)	Configurable
	2		Analogue multifunctional output (mA, V DC)	Configurable
	4		Digital input	Configurable
	4		Analogue multifunctional input (mA, V DC, RMI)	Configurable

IOM3.2 technical specifications

Category	Specification
Relay outputs 	Relay type: Solidstate relay Electrical rating and UL/cUL Listed: 30 V DC, and 6 A, resistive; B300, pilot duty (B300 is a power limit specification for inductive loads) Voltage withstand: ±36 V DC
Analogue multifunctional outputs	Current output: <ul style="list-style-type: none"> Range: Any custom range between -25 to 25 mA DC

Category	Specification
<p>← I_V</p>	<ul style="list-style-type: none"> • Accuracy: 1 % of range • Resolution: 16 bits (< 2 uA / bit) • Type: Active output (internal supply) • Load: Maximum ±25 mA → 400 Ω <p>Voltage output:</p> <ul style="list-style-type: none"> • Range: Any custom range between -10 to 10 V DC • Accuracy: 1 % of range • Resolution: 16 bits (< 0,7 mV / bit) • Load: Minimum ±10V -> 600 Ω • Internal resistance, power ON: < 1 Ω • Internal resistance, power OFF: > 10 MΩ <p>General information for all outputs:</p> <ul style="list-style-type: none"> • Refresh rate (max): 50ms (input to output) • Voltage withstand: ±36 V DC
<p>Analogue multifunctional PWM outputs</p> 	<p>PWM output:</p> <ul style="list-style-type: none"> • Frequency range: 1 to 2500 Hz ±5 Hz • Duty cycle accuracy (5 to 95 %): 0.5 % within reference temperature range • Resolution: 12 bits (4096 steps) • Voltage: Low level: < 0.5 V. High level: > adjustable 1 to 10 V. Maximum: 10.2 V • Output impedance: 25 Ω <p>General information for all outputs:</p> <ul style="list-style-type: none"> • Refresh rate (max): 50 ms (input to output) • Voltage withstand: ±36 V DC
<p>Digital inputs</p> 	<p>Negative or positive trigger inputs:</p> <ul style="list-style-type: none"> • ON: -36 to -8 V DC, and 8 to 36 V DC • OFF: -2 to 2 V DC <p>Minimum pulse length: 50 ms Impedance: 3.9 kΩ Voltage withstand: ±36 V DC</p>
<p>Analogue multifunctional inputs</p> 	<p>Digital inputs with wire break detection:</p> <ul style="list-style-type: none"> • Dry contact inputs, 3 V DC internal supply • Wire-break detection with maximum resistance for ON detection: 100 Ω to 400 Ω <p>Current inputs:</p> <ul style="list-style-type: none"> • From active transmitter: 0 to 20 mA, or 4 to 20 mA • Accuracy: ±10 uA ±0.25 % of actual reading <p>Voltage inputs (DC):</p> <ul style="list-style-type: none"> • Range: ±10 V DC / 0 to 10 V DC • Accuracy: ±10 mV ±0.25 % of actual reading <p>Resistance measurement inputs, 2 wire (RMI):</p> <ul style="list-style-type: none"> • Resistance measurement: 0 to 4.5 kΩ • Accuracy: ±1 Ω ±0.25 % of actual reading <p>Resistance measurement inputs, 1 wire (RMI):</p> <ul style="list-style-type: none"> • Resistance measurement: 0 to 4.5 kΩ • Accuracy: ±2 Ω ±0.25 % of actual reading <p>Pt100:</p> <ul style="list-style-type: none"> • Range: -200 to 850 °C • Accuracy: ±1 °C ±0.25 % of actual reading <p>Pt1000:</p>

Category	Specification
	<ul style="list-style-type: none"> • Range: -200 to 850 °C • Accuracy: ± 0.5 °C ± 0.25 % of actual reading <p>Thermocouple type, range and accuracy:</p> <ul style="list-style-type: none"> • E: -200 to 1000 °C (± 2 °C ± 0.25 % of actual reading) • J: -210 to 1200 °C (± 2 °C ± 0.25 % of actual reading) • K: -200 to 1372 °C (± 2 °C ± 0.25 % of actual reading) • N: -200 to 1300 °C (± 2 °C ± 0.25 % of actual reading) • R: -50 to 1768 °C (± 2 °C ± 0.25 % of actual reading) • S: -50 to 1768 °C (± 2 °C ± 0.25 % of actual reading) • T: -200 to 400 °C (± 2 °C ± 0.25 % of actual reading) <p>Note: Twisted pair and shielded cable is recommended to achieve specification and optimisation of noise immunity.</p> <p>General information for all outputs:</p> <ul style="list-style-type: none"> • Refresh rate (max): 50 ms (input to output) • Voltage withstand: ± 36 V DC • All analogue multi-functional inputs have a common ground
Terminal connections	<p>Relay outputs: Terminals: Standard 45° plug, 2.5 mm² Wiring: 0.5 to 2.5 mm² (22 to 14 AWG), multi-stranded</p> <p>Other inputs: Terminals: Standard 45° plug, 1.5 mm² Wiring: 0.1 to 1.5 mm² (28 to 16 AWG), multi-stranded</p>
Torques and terminals	<p>Module faceplate screws: 0.5 N·m (4.4 lb-in)</p> <p>Connection of wiring to relay output terminals: 0.5 N·m (4.4 lb-in)</p> <p>Connection of wiring to digital input terminals: 0.25 N·m (2.2 lb-in)</p> <p>UL/cUL Listed: Wiring must be minimum 90 °C (194 °F) copper conductors only</p>
Galvanic isolation	<p>Between relay groups and other I/Os: 2210 V, 50 Hz for 60 s</p> <p>Between other input groups and other I/Os: 600 V, 50 Hz for 60 s</p>
Ingress protection	<p>Unmounted: No protection rating</p> <p>Mounted in rack: IP20 according to IEC/EN 60529</p>
Dimensions	L×H×D: 28 × 162 × 150 mm (1.1 × 6.4 × 5.9 in)
Weight	188 g (0.4 lb)

2.4.10 Input/output module IOM3.3

The input output module has 10 analogue multifunctional inputs. These I/Os are all configurable.

IOM3.3 terminals

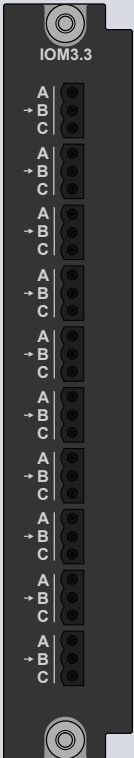
Module	Count	Symbol	Type	Name
	10	A → B C	Analogue multifunctional inputs (mA, V DC, RMI)	Configurable

IOM3.3 technical specifications



Category	Specification
Analogue multifunctional inputs A → B C	<p>Digital inputs with wire break detection:</p> <ul style="list-style-type: none"> • Dry contact inputs, 3 V DC internal supply • Wire-break detection with maximum resistance for ON detection: 100 Ω to 400 Ω <p>Current inputs:</p> <ul style="list-style-type: none"> • From active transmitter: 0 to 20 mA, or 4 to 20 mA • Accuracy: ±10 uA ±0.25 % of actual reading <p>Voltage inputs (DC):</p> <ul style="list-style-type: none"> • Range: ±10 V DC / 0 to 10 V DC • Accuracy: ±10 mA ±0.25 % of actual reading <p>Resistance measurement inputs, 2 or 3 wire (RMI):</p> <ul style="list-style-type: none"> • Resistance measurement: 0 to 4.5 kΩ • Accuracy: ±1 Ω ±0.25 % of actual reading <p>Resistance measurement inputs, 1 wire (RMI):</p> <ul style="list-style-type: none"> • Resistance measurement: 0 to 4.5 kΩ • Accuracy: ±2 Ω ±0.25 % of actual reading <p>Pt100:</p> <ul style="list-style-type: none"> • Range: -200 to 850 °C • Accuracy: ±1 °C ±0.25 % of actual reading <p>Pt1000:</p> <ul style="list-style-type: none"> • Range: -200 to 850 °C • Accuracy: ±0.5 °C ±0.25 % of actual reading <p>Thermocouple type, range and accuracy:</p> <ul style="list-style-type: none"> • E: -200 to 1000 °C (±2 °C ±0.25 % of actual reading) • J: -210 to 1200 °C (±2 °C ±0.25 % of actual reading)

Category	Specification
	<ul style="list-style-type: none"> • K: -200 to 1372 °C (±2 °C ±0.25 % of actual reading) • N: -200 to 1300 °C (±2 °C ±0.25 % of actual reading) • R: -50 to 1768 °C (±2 °C ±0.25 % of actual reading) • S: -50 to 1768 °C (±2 °C ±0.25 % of actual reading) • T: -200 to 400 °C (±2 °C ±0.25 % of actual reading) <p>Note: Twisted pair and shielded cable is recommended to achieve specification and optimisation of noise immunity.</p> <p>General information for all inputs:</p> <ul style="list-style-type: none"> • Voltage withstand: ±36 V DC
Internal cold junction compensation (CJC)	<p>Internal temperature sensor:</p> <ul style="list-style-type: none"> • Range: 0 to 70 °C <ul style="list-style-type: none"> ◦ Accuracy: ±1.0 °C • Range: -40 to 0 °C <ul style="list-style-type: none"> ◦ Accuracy: ±2.0 °C <p>Mathematical compensation:</p> <ul style="list-style-type: none"> • If non channels are configured as 4-20 mA <ul style="list-style-type: none"> ◦ Accuracy: ±1.0 °C • If any channels are configured as 4-20 mA <ul style="list-style-type: none"> ◦ Accuracy: ±1.5 °C <p>If it is needed to have 4-20 mA channels on the same card, it is recommended to use the top channels for 4-20 mA and the lower channels for TC's</p> <p>Internal cold junction accuracy:</p> <ul style="list-style-type: none"> • Heat dissipated by nearby heat sources can cause errors in thermocouple measurements by heating the IOM3.3 terminals to a different temperature than the cold-junction compensation sensor. Thermal gradient across the terminals can cause the terminals of different IOM3.3 channels to be at different temperatures, which creates accuracy errors and affects the relative accuracy between channels. • The temperature measurement accuracy specifications include errors caused by the thermal gradient across the IOM3.3 terminals for configurations with the IOM3.3 terminals facing forward or upward.
Terminal connections	<p>Terminals: Standard 45° plug, 1.5 mm²</p> <p>Wiring: 0.1 to 1.5 mm² (28 to 16 AWG), multi-stranded</p>
Torques and terminals	<p>Module faceplate screws: 0.5 N·m (4.4 lb-in)</p> <p>Connection of wiring to relay output terminals: 0.5 N·m (4.4 lb-in)</p> <p>Connection of wiring to input terminals: 0.25 N·m (2.2 lb-in)</p> <p>UL/cUL Listed: Wiring must be minimum 90 °C (194 °F) copper conductors only</p>
Galvanic isolation	<p>All 10 multi inputs have a common ground</p> <p>Galvanic isolation from rack: 600 V, 50 Hz for 60 s</p>
Dimensions	L×H×D: 28 × 162 × 150 mm (1.1 × 6.4 × 5.9 in)
Weight	164 g (0.4 lb)

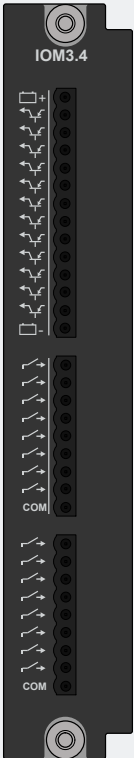

2.4.11 Input/output module IOM3.4

The input output module has 12 digital outputs, and 16 digital inputs. These I/Os are all configurable.

IOM3.4 terminals

Module	Count	Symbol	Type	Name
	12		Digital output	Configurable
	16		Digital input	Configurable

IOM3.4 technical specifications

Category	Specification
Digital outputs 	Transistor type: PNP Supply voltage: 12 or 24 V DC nominal, maximum 36 V DC (relative to common) Maximum current (per output): < 55 °C: 250 mA; > 55 °C: 200 mA Leak current: Typical 1 µA, maximum 100 µA (temperature-dependent) Saturation voltage: Maximum 0.5 V Non-replaceable 4 A fuse Voltage withstand: ±36 V DC Load dump protected by TVS diodes Short circuit protection Reverse polarity protection Internal freewheeling diode
Digital inputs 	Bipolar inputs <ul style="list-style-type: none"> ON: -36 to -8 V DC, and 8 to 36 V DC OFF: -2 to 2 V DC Minimum pulse length: 50 ms Impedance: 4.7 kΩ Voltage withstand: ±36 V DC
Terminal connections	Terminals: Standard 45° plug, 1.5 mm ² Wiring: 0.1 to 1.5 mm ² (28 to 16 AWG), multi-stranded
Torques and terminals	Module faceplate screws: 0.5 N·m (4.4 lb-in) Connection of wiring to terminals: 0.25 N·m (2.2 lb-in) UL/cUL Listed: Wiring must be minimum 90 °C (194 °F) copper conductors only
Galvanic isolation	Between groups: 600 V, 50 Hz for 60 s
Ingress protection	Unmounted: No protection rating Mounted in rack: IP20 according to IEC/EN 60529

Category	Specification
Dimensions	L×H×D: 28 × 162 × 150 mm (1.1 × 6.4 × 5.9 in)
Weight	175 g (0.4 lb)

2.4.12 Processor and communication module PCM3.3

The PCM3.3 module offers a powerful quad core 1.6 GHz 64 bit CPU, well suited for high-end C/C++ * and CODESYS applications, data logging for power management or power control applications. The module provides a 100 Mbps Ethernet network interface (prepared for TSN) for real-time power plant management network and 4 managed switched 10/100 Mbps network interfaces for local network. CAN/CANopen connectivity are provided as on-module interfaces. The DisplayPort connector allows connection of standard LED/LCD monitors for graphical visualization (up to 1080p).

PCM3.3 has 4 x CAN ports and 1 x RS-232/485 port and 1 x RS-485 port for serial bus connectivity. It has a *Self-check OK* LED.

By default the module is provided with screw terminals.

NOTE * Contact DEIF for availability.

PCM3.3 terminals

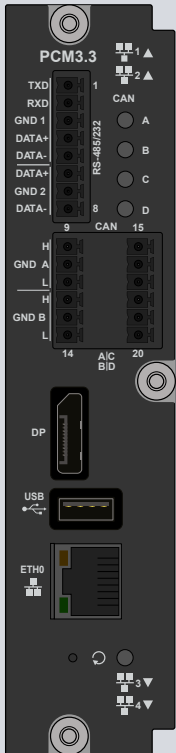
Module	Count	Symbol	LED	Type	Name
	5	ETH0 1 to 4	<ul style="list-style-type: none"> Off : No communication Green : Communication connected Green flash : Active communication 	Ethernet (RJ45)	Two connections at the top of the hardware module, one on the front, and two at the bottom.
	1	Self-check OK LED symbol	<ul style="list-style-type: none"> Off : Self-check not OK Green : Self-check OK 		
	1	USB		USB host (Type-A)	
	1	DP		DisplayPort (DP full size)	
	4	H, GND A to D, L	<ul style="list-style-type: none"> Off : No communication Green : CAN connected 	CAN port	CAN bus
	1	COM 1		RS-232/485 port	
	1	COM 2		RS-485 port	

PCM3.3 technical specifications

Power supply and backplane	
Power supply	From backplane via PSM3.x module.
Backplane interfaces	1x EtherCAT OUT (Port 1) - LVDS. 1x EtherCAT OUT (Port 2) - LVDS.

Interfaces	
Ethernet	1 x Ethernet (ETH 0) (prepared for TSN support) : 100/100BASE-T, 8P8C (RJ45), shielded Cat5e, >0.76 µm gold plating. 4 x Ethernet, Managed Switch (ETH 1 to 4) : 10/100BASE-T, 8P8C (RJ45), shielded Cat5e, >0.76 µm gold plating.
CAN	4 x CAN (CAN 1 to 4) : ISO 11898, shielded twisted copper cable, 50 to 1,000 kbit/s, selectable termination resistors.
UART	COM 1 and COM 2: 2(1) x RS-485 (COM 1, COM 2) : TIA/EIA-485 shielded twisted copper cable 4.8 to 921.6 kbit/s (half duplex) COM 1 only: 1 x RS-232 (COM 1) : TIA/EIA-232E shielded copper cable 4.8 to 115.2 kbit/s (full duplex)
DisplayPort	1 x DisplayPort(DP) 1.3 1080p (Full-size connector). External third-party non-DEIF displays should be configured to Input mode instead of Automatic detection.
USB Host	1x USB 3.0 (Type-A connector), Mass Storage Class. Power delivery up to 4.5 W.
LED	See terminals.
Pin-hole switch	Factory Reset Provisioning of module (Software configurable). **

CPU	
Processor	1.6 GHz Quad-core industrial grade ARMv8 64 bit CPU with ECC protected cache.
Memory	2 GB LPDDR4.
Internal storage	32 GB 3D TLC NAND flash running in pseudo SLC mode. 7 GB available for user application data.
Persistent storage	128 kB user available from CODESYS (256 kB FRAM installed).
Real-Time Clock (RTC) battery	Real time clock with replaceable coin-cell battery. CR2430 3V battery, rated for operation at -40 to 85°C (-40 to 185 °F). This is not a standard CR2430 battery. The CR2430 battery is an available accessory. Contact DEIF for ordering.
Cooling	Passive.
Other features	CPU junction temperature measurement. Software reset on high CPU temperature.

Other	
Dimensions	L×H×D: 36.8 × 162 × 142 mm (1.44 × 6.37 × 5.59 in)
Weight	~ 226 g (0.49 lb)
Power consumption	~ 16 W, hereof 5.6 W reserved for USB3.0 host
Torques and terminals	Module faceplate screws: 0.5 N·m (4.4 lb-in). Connection of wiring to terminals: 0.5 N·m (4.4 lb-in). UL/ULC Listed: Wiring must be minimum 90 °C (194 °F) copper conductors only.
Ingress protection	Unmounted: No protection rating Mounted in rack: IP20 according to IEC/EN 60529

Software	
Operating system	DEIF In-house maintained operating system (BSPv5).

Software

	<p>Real-time patched Linux®. GNU/Linux customized with PREEMPT realtime patch and system drivers. C/C++ * and CODESYS applications are running in userspace mode. Fail-safe system software start up with two OS images (active and fault-back) Power fail-safe, self-monitoring and error correcting file system. Secure boot (Chain-of-trust).</p>
Cybersecurity	<p>Conforming to IACS UR E27 Connections to untrusted networks may require additional equipment or security counter-measures not included in the product.</p>
System configuration	<p>On-device web-based configuration. System information. Simplified update procedures (no special tools, same for OS and firmware). User access management (Multiuser access), rights and credentials. Network configuration of the build-in 4 port managed switch (VLAN). IPv4 and IPv6 support (static/dynamic). Network Time protocol support as Client. Discover the device via hostname (mDNS services). Device configuration backup and restore.</p>
System network protocols	<p>Network Time Protocol (NTP), server and client. Dynamic Host Configuration Protocol (DHCP), client. IGH Master (Native for C/C++ applications * / System network scan). **</p>

Programming (iE 350 PLC)

PLC run-time	<p>CODESYS V3 runtime: CODESYS V3.5 SP 18. iE 350 LAND / MARINE (CODESYS Single Core support), iE 350 PLC (CODESYS Multi Core support).</p>
Programming languages	<p>IEC61131-3: LD, SFC, FBD, ST (CODESYS V3.5 SP18+ IDE). ANSI C/C++: * ANSI C/C++ via Linux SDK. *</p>
Visualisation	<p>CODESYS webvisualisation (Option). WEB-Visu rendering for DisplayPort.</p>
Application protocols	<p>Ethernet: OPC UA Server, OPC UA Client via Single License (CODESYS Store) Modbus TCP Server (CODESYS) Modbus TCP Client (CODESYS) PROFINET V2.3 Class A RT CONTROLLER (CODESYS) PROFINET V2.3 Class A RT DEVICE (CODESYS) HTTPS/WSS/JSON (CVI DEIF component) *** OPC UA Server (Open62541 - DEIF component) Modbus TCP Server (libModbus - DEIF Component) Modbus TCP Client (libModbus - DEIF component)</p> <p>Fieldbuses: EtherCAT master(CODESYS)</p> <p>CANOpen Client (CODESYS) CANOpen Server (CODESYS) CAN Layer II (via CODESYS library) J1939 (CODESYS) Modbus RTU Client (CODESYS) Modbus RTU Server (CODESYS) Modbus RTU Client (libModbus - DEIF component) **</p>

NOTE * Contact DEIF for availability.

** For future use.

*** Deprecated support.

2.4.13 Blind module

A blind module must be used to close off each empty slot in the rack.

Blind module technical specifications

Category	Specification
Tightening torque	Module faceplate screws: 0.5 N·m (4.4 lb-in)
Dimensions	L×H×D: 28 × 162 × 18 mm (1.1 × 6.4 × 0.7 in)
Weight	44 g (0.1 lb)

2.4.14 Small blind module

A small blind module is required for extension racks.

Small blind module technical specifications

Category	Specification
Tightening torque	Module faceplate screws: 0.5 N·m (4.4 lb-in)
Size	L×H×D: 14 × 162 × 18 mm (0.5 × 6.4 × 0.7 in)
Weight	12 g (0.03 lb)

2.5 Controller or extension racks

2.5.1 Rack R4.1

Category	Specification
Ingress protection	IP20 (all slots must have modules or blind modules mounted) according to IEC/EN 60529
UL/cUL Listed	Type Complete Device, Open Type 1
Material	Rack frame: Aluminium
Mounting	Base mount, using four M6 bolts with self-locking washers (or self-locking screws). The bolts and self-locking washers (or self-locking screws) are not included with the rack. UL/cUL Listed: For use on a flat surface of a type 1 enclosure UL/cUL Listed: To be installed in accordance with the NEC (US) or the CEC (Canada)
Tightening torque	Mounting bolts: 4 N·m (35 lb-in)

2.5.2 Rack R7.1

Category	Specification
Ingress protection	IP20 (all slots must have modules or blind modules mounted) according to IEC/EN 60529
UL/cUL Listed	Type Complete Device, Open Type 1
Material	Rack frame: Aluminium
Mounting	Base mount, using four M6 bolts with self-locking washers (or self-locking screws).

Category	Specification
	<p>The bolts and self-locking washers (or self-locking screws) are not included with the rack.</p> <p>UL/cUL Listed: For use on a flat surface of a type 1 enclosure UL/cUL Listed: To be installed in accordance with the NEC (US) or the CEC (Canada)</p>
Tightening torque	Mounting bolts: 4 N·m (35 lb-in)

2.6 iE 7 display

2.6.1 Terminal connections

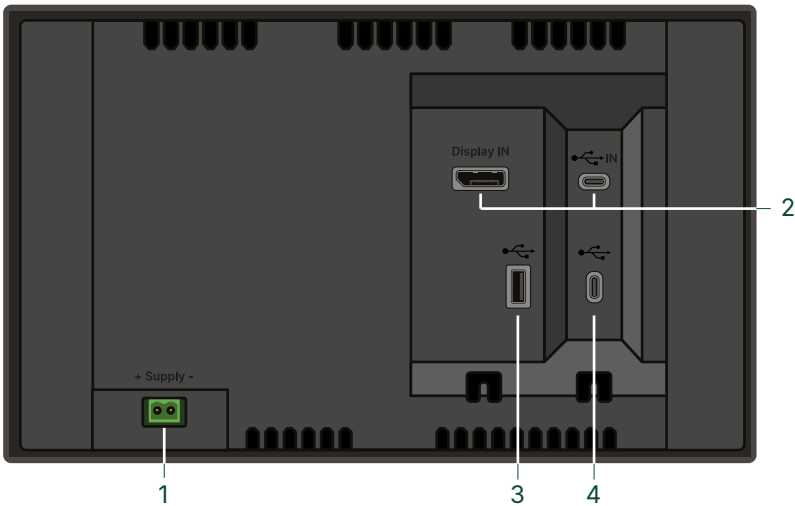

No.	Function	Notes
1	Power supply	1 Power supply (DC+/-)
2	DisplayPort USB IN	Connection to base-mounted controller. USB 2.0 host (type C)
3	USB	USB 2.0 host (type A)
4	USB	USB 2.0 host (type C)

2.6.2 Electrical specifications

Power supply	
Input voltage	Nominal voltage: 12 V DC or 24 V DC (Operation range: 6.5 to 36 V DC) Power up at 8 V Operation down to 6.5 V at 15 W Operation down to 6.9 V at 28 W
Voltage withstand	Reverse polarity
Power supply drop-out immunity	0 V DC for 50 ms (coming from more than 6.5 V DC) at 15 W
Power supply load dump protection	Load dump protected according to ISO16750-2 test A
Power consumption	15 W typical 28 W maximum

Battery voltage measurement	
Accuracy	± 0.8 V within 8 to 32 V DC, ± 0.5 V within 8 to 32 V DC @ 20 °C

2.6.3 Communication specifications

Communication specifications	
DisplayPort *	Connection to base-mounted controller.
USB IN *	Connection to base-mounted controller. USB 2.0 (type C).

Communication specifications

USB hub Type A	For future use.
----------------	-----------------

USB hub Type C	For future use.
----------------	-----------------

NOTE * Both DisplayPort and USB IN are required for communication and control to the controller.

2.7 Accessories

2.7.1 USB type A to C cable

The USB cable is necessary for control between the display and base-mounted controller.

This is supplied with the iE 7 display.

Category	Specification
Cable type	USB type A to type C cable.
USB	USB 2.0
Length	3.0 m (9.85 ft)

2.7.2 DisplayPort cable

The DisplayPort cable is necessary for visual HMI between the display and base-mounted controller.

This is supplied with the iE 7 display.

Category	Specification
Cable type	VESA DisplayPort compliant cable.
Length	3.0 m (9.85 ft)

2.7.3 Ethernet cable

The Ethernet cable from DEIF meets the technical specifications below.

Category	Specification
Cable type	Shielded patch cable SF/UTP CAT5e
Temperature	Fixed installation: -40 to 80 °C (-40 to 176 °F) Flexible installation: -20 to 80 °C (-4 to 176 °F)
Minimum bending radius (recommended)	Fixed installation: 25 mm (1 in) Flexible installation: 50 mm (2 in)
Length	2 m (6.6 ft)
Weight	~110 g (4 oz)

2.8 Approvals

Standards
CE
UKCA

PLC certificates	Cybersecurity IACS UR E27
ABS	Yes
BV	Yes
DNV	Yes
LR	Yes

**More information**

See Approvals/certifications for the most recent certificates www.deif.com/documentation/ie-350-plc/.

2.9 Cybersecurity

Category	Specification
Cybersecurity	Certified to IACS UR E27 *

NOTE * Connections to untrusted networks may require additional equipment or security counter-measures not included in the product.

3. Application development

3.1 IEC61131-3 programming

Application Development

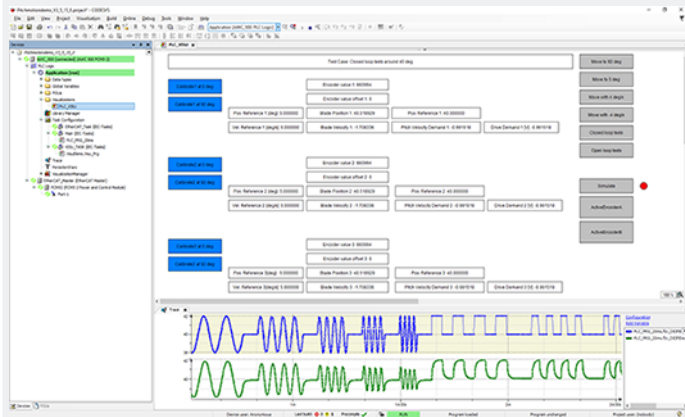

iE 250 / 350 / 650 PLC software



IEC61131-3 PLC-programmed based on CODESYS V3 Programming languages:

- Sequential Function Chart (SFC)
- Function Block Diagram (FBD)
- Structured Text (ST)
- Ladder Diagram (LD)
- Multi-language help in Chinese, German and English
- Programmed via Ethernet connection (TCP/IP)
- Download of boot projects and source code
- Integrated PLC and task configuration
- Web visualisation on PanelPC or remote via Secure communication (HTTPS)
- Online debugging and sampling
- Trace-integrated simulation

- CODESYS V3.5 IDE
- DEIF iE x50 CODESYS TSP (Target Support Package) with EtherCAT device description files.

3.2 Supported software features

Software	PLC Linux SDK	PLC CODESYS (with Web visualization)
PLC runtime	-	CODESYS V3.5 SP20 Patch 4
Programming		
IEC61131-3	-	LD, SFC, FBD, CFC, ST
	-	CODESYS V3.5 SP20 Patch 4 IDE
Network protocols		
	Network Time Protocol (NTP) or Precision Time Protocol (PTP), client	
	Dynamic Host Configuration Protocol (DHCP), client	
Visualisation		
	HTML5/Javascript via build-in webservers	CODESYS Web visualisation
System Configuration		
	Web based system configuration for IP address (static/dynamic), system information.	
Device handling	See Communication protocols	CODESYS Device handling (EtherCAT Master, CANOpen Manager, Modbus TCP)
Configuration		
Visualisation designer		CODESYS V3.5 visualisation

Software	PLC Linux SDK	PLC CODESYS (with Web visualization)
Scope/trace		Scope/trace
HMI visualisation tool		CODESYS web visualisation
		Panel PC and remote HMI client (communication via HTTPS) Requires: Browser with HTML5/JavaScript support, such as Chrome, Firefox, Safari, Edge, and more (Kiosk mode possible)

Communication protocols

Software	PLC Linux SDK	PLC CODESYS (with Web visualization)
OPC UA Server	-	Yes - OPC UA Server (CODESYS) open62541 (DEIF)
OPC UA Client	-	Yes - OPC UA Client (CODESYS)
Modbus TCP Server	-	Yes - Modbus TCP Server (CODESYS) libModbus (DEIF)
Modbus TCP Client	-	Yes - Modbus TCP Server (CODESYS) libModbus (DEIF)
Modbus RTU Master	-	Yes - Modbus TCP Server (CODESYS) libModbus (DEIF)
Modbus RTU Slave	-	Yes - Modbus RTU Slave (CODESYS)
EtherCAT Master	-	Yes - EtherCAT Master (CODESYS)
CAN Layer II	-	Yes - via CODESYS library
CANopen Master	-	Yes - CANopen Master (CODESYS)
CANopen Slave	-	Yes - CANopen Slave (CODESYS)
PROFINET V2.3 Class A RT CONTROLLER	-	Yes - (CODESYS)
PROFINET V2.3 Class A RT DEVICE	-	Yes - (CODESYS)
Others		On request or via CODESYS Single License

4. Legal information

4.1 Disclaimer and copyright

Open source software

This product contains open source software licensed under, for example, the GNU General Public License (GNU GPL) and GNU Lesser General Public License (GNU LGPL). The source code for this software can be obtained by contacting DEIF at support@deif.com. DEIF reserves the right to charge for the cost of the service.

General warranty

The warranty period for the purchased product is defined in the contract and order acknowledgement. In general, DEIF's Terms and Conditions of Sale and Delivery apply.

The product continuously monitors the operating temperature and stores this information in a log file on the device. DEIF uses this information for service purpose and to validate if issues with the product are covered by the warranty.

The software packages supplied are believed to be of the highest quality. Due to the nature of the software development process, it is possible that there are hidden defects in the software which may affect its use, or the operation of any software or device developed with this software package.

DEIF does not undertake responsibility for determining whether this package is suitable for the application, nor for ensuring the correct operation of the application software and hardware.

The warranty does not cover product wear parts, such as:

- Internal flash disc
- If applicable, SD card (purchased separately)
- Replaceable coil-cell battery, used for the real-time clock (available as a spare part)

Use of Non-cybersecurity certified software (Developer edition firmware)

The Developer/Engineering Edition Firmware (identified as *iE x50 UPE vX* software bundle) is intended solely for advanced development purposes.

It permits users to edit or remove embedded cybersecurity rules and policies, perform customisations, run own applications or integrate 3rd party software, that inhibits DEIF to take responsibility for the software to comply with product relevant cybersecurity standards.

To the extent that the customer modifies or disables such cybersecurity features, DEIF shall bear no responsibility or liability for any resulting security vulnerabilities, unauthorized external access, data breaches, or any other interference or damages affecting the project. The customer assumes full responsibility for the consequences of any such modifications and has the responsibility for relevant cybersecurity certifications.

Trademarks

DEIF and the DEIF logo are trademarks of DEIF A/S.

BELDEN is a trademark of BELDEN INC.

Adobe®, Acrobat®, and Reader® are either registered trademarks or trademarks of Adobe Systems Incorporated in the United States and/or other countries.

CANopen® is a registered community trademark of CAN in Automation e.V. (CiA).

SAE J1939® is a registered trademark of SAE International®.

CODESYS® is a trademark of CODESYS GmbH.

EtherCAT®, EtherCAT P®, Safety over EtherCAT®, are trademarks or registered trademarks, licensed by Beckhoff Automation GmbH, Germany.

VESA® and DisplayPort® are registered trademarks of Video Electronics Standards Association (VESA®) in the United States and other countries.

Google® and Google Chrome® are registered trademarks of Google LLC.

Linux® is a registered trademark of Linus Torvalds in the U.S. and other countries.

Modbus® is a registered trademark of Schneider Automation Inc.

Torx®, Torx Plus® are trademarks or registered trademarks of Acument Intellectual Properties, LLC in the United States or other countries.

Windows® is a registered trademark of Microsoft Corporation in the United States and other countries.

All trademarks are the properties of their respective owners.

Copyright

© Copyright DEIF A/S. All rights reserved.

Disclaimer

DEIF A/S reserves the right to change any of the contents of this document without prior notice.

The English version of this document always contains the most recent and up-to-date information about the product. DEIF does not take responsibility for the accuracy of translations, and translations might not be updated at the same time as the English document. If there is a discrepancy, the English version prevails.