

SGC 120

Single Genset Controller

Data sheet

4921240630C

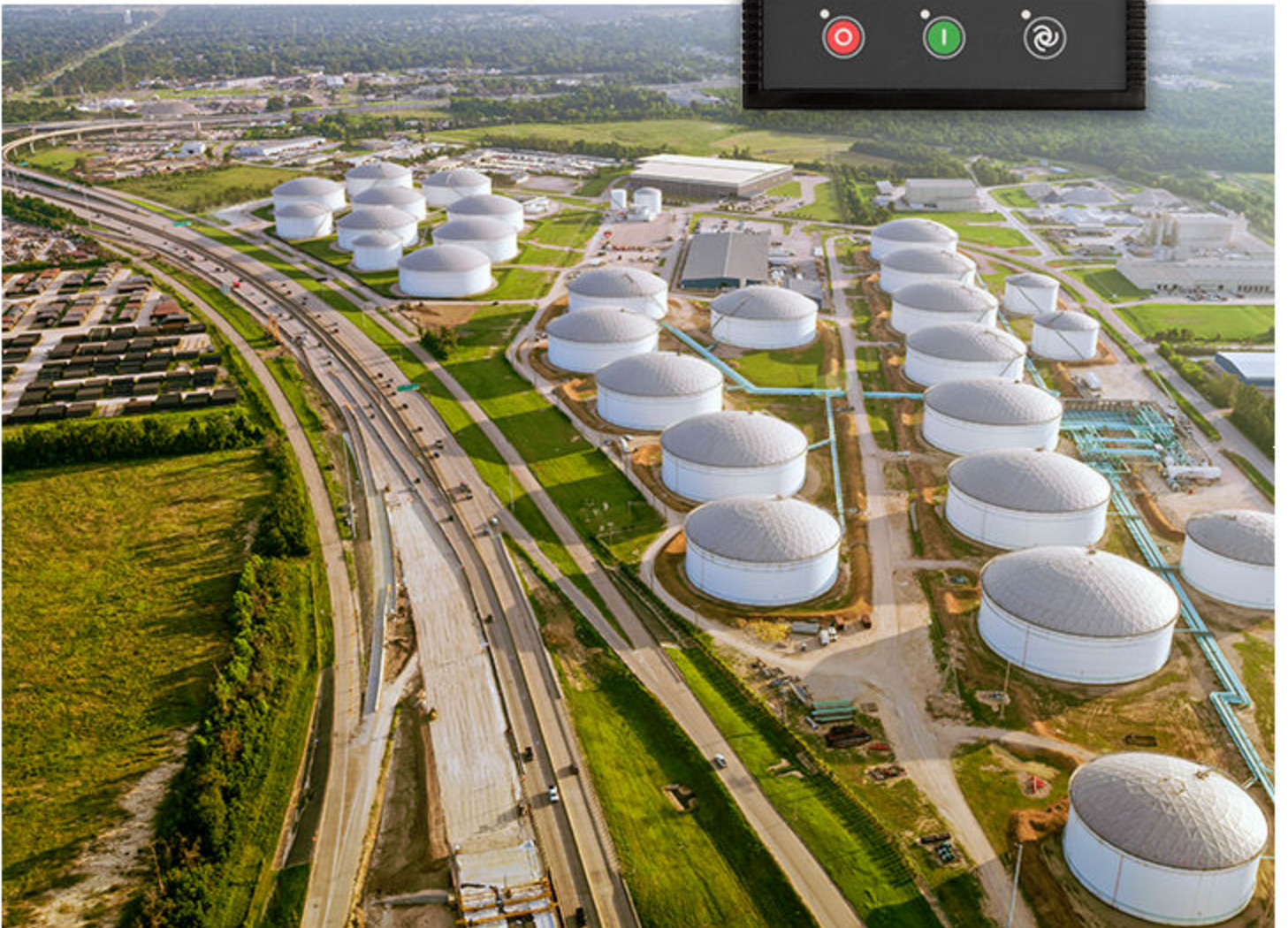

1. SGC 120

1.1 About	3
1.1.1 Software versions.....	3
1.2 Single-line application diagrams	3
1.3 Functions	4
1.4 Display, buttons, and LEDs	6
1.5 Protections overview	7

2. Technical specifications

2.1 Electrical specifications	8
2.1.1 Power supply.....	8
2.1.2 Genset voltage and frequency measurements.....	8
2.1.3 Genset current measurements.....	9
2.1.4 Mains voltage and frequency measurement.....	9
2.1.5 Digital inputs.....	9
2.1.6 Analogue resistive sensor inputs.....	10
2.1.7 Analogue voltage/current input.....	10
2.1.8 Analogue inputs used as digital inputs.....	10
2.1.9 Magnetic pickup (MPU)/W-point frequency input.....	10
2.1.10 D+ charger alternator.....	11
2.1.11 Sensor common point.....	11
2.1.12 Communication ports.....	11
2.1.13 Digital outputs.....	12
2.2 Environmental specifications	12
2.3 Terminals	13
2.4 Approvals	14
2.5 Dimensions	15

3. Legal information

1. SGC 120

1.1 About

The SGC 120 controller contains all the functions needed to protect and control the genset, the genset breaker, and also a mains breaker. The values and alarms are shown on the LCD display screen, and operators can control the system from the display.

You can use the DEIF Smart connect software to configure the inputs and outputs. You can also configure the parameters on the controller.

1.1.1 Software versions

The information in this document relates to software versions:

Software	Versions
Application software	9.04

1.2 Single-line application diagrams

Island mode

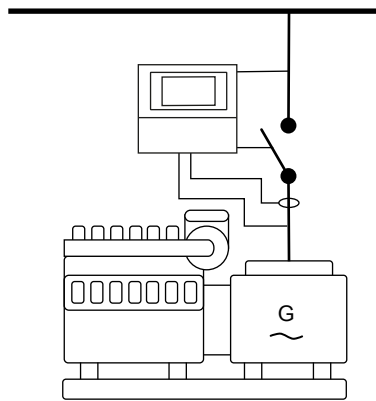

Island: Island mode is typically used in power plants that are isolated from other power generation systems.

Engine drive

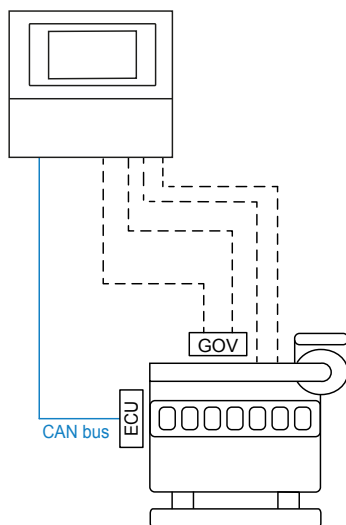

Engine drive: Use the controller to control one engine. The controller has all the necessary functions to control and protect the engine.

Automatic mains failure (AMF), remote start/stop, and auto exercise mode

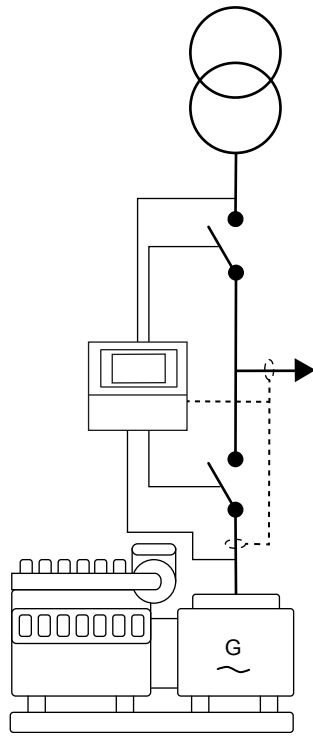

AMF: If there is a significant loss of mains power or a total blackout, the controller automatically changes the supply to the generator. This makes sure that there is power during a mains failure and prevents damage to electrical equipment.

Remote start/stop: Activate the configured start/stop inputs to remotely start or stop the genset.

Auto exercise mode: Use the auto exercise mode to schedule a maximum of two start/stop sequences for the genset. You can also configure the load transfer on the mains/genset.

You can place the CT on the line from the genset or on the load side.

1.3 Functions

Genset functions

Start/stop sequences

Input for genset alternator voltage or D+ charging alternator

Counters, including:

- Engine running hours
- Start attempts
- Maintenance

Input for fuel reference selection

Fuel theft alarm

Monitoring of engine and alternator parameters

Idle speed control

Coolant temperature control

Automatic fuel transfer

Mains functions

Mains support (voltage and frequency)

Mains monitoring

General functions

Analogue current and voltage input

Analogue resistive inputs

General functions

Digital switch input

Digital outputs

Event logs with real-time clock

EEPROM for extended event logs

2-level password protection

You can change the mode on the fly when the is in operation and when the engine is stopped

Counters

Maintenance

Running hours

Genset and mains energy

Display and language functions

Supports multiple languages, for example, English, Chinese, and Spanish

Graphical display

Parameters can be changed on the display

Display views change automatically after an adjustable delay time

Deep sleep mode

Running modes

Manual

Auto

Modes of operation

Island

Automatic mains failure (AMF)

Remote start/stop

Auto exercise

Engine drive

Communication

RS-485 for Modbus

USB interface to PC

CAN

1.4 Display, buttons, and LEDs

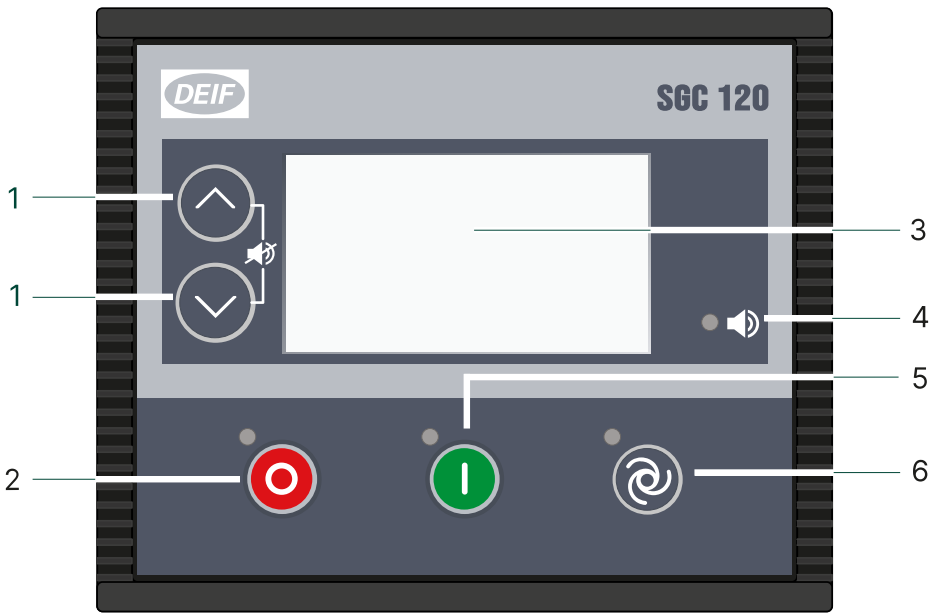

No.	Name	Function
1	Navigation	<p>Move the selector up and down on the screen.</p> <p>To see the <i>Event log</i>, push the <i>Up</i> (⬆️) button and the <i>down</i> (⬇️) button at the same time and hold.</p>
2	Stop	<p>Stops the genset if manual or auto mode is selected.</p> <p>When you push the button in auto mode, the running mode also changes to manual mode.</p>
2	Configuration	<p>To go to the <i>Configuration menu</i>, make sure the controller is in manual mode, and then push and hold the <i>Stop</i> (⊞) button until you see the configuration screen. To go back to manual mode, push and hold the <i>Stop</i> (⊞) button.</p> <p>Push the <i>Start</i> (ⓘ) button to select a parameter and to save the changes you have made.</p>
2 and 1	Programming	<p>To go to the <i>Programming menu</i>, make sure the controller is in manual mode. Then push the <i>down</i> (⬇️) button and the <i>Stop</i> (⊞) button at the same time and hold until you see the programming screen. To go back to manual mode, push the <i>down</i> (⬇️) button and the <i>Stop</i> (⊞) button at the same time and hold.</p> <p>To see the <i>Event log</i>, make sure the controller is in the <i>Programming menu</i>. Then push the <i>Up</i> (⬆️) button and the <i>Stop</i> (⊞) button at the same time and hold until you see the programming screen. To go back to the <i>Programming menu</i>, push the <i>down</i> (⬇️) button and the stop button at the same time and hold.</p>
3	Display	Graphical
4	Alarm LED	The LED is red when there is an active alarm.
5	Start	Starts the genset when manual mode is selected.
6	Mode selection	Push to change the running mode.

1.5 Protections overview

Generator protections

Protections	No. of	ANSI
Under-voltage	x2	27P
Over-voltage	x2	59
Under-frequency	x2	81U
Over-frequency	x2	81O
Unbalanced load	x1	-
Over-current	x1	50TD
Overload	x1	32F
Low load	x1	-
Reverse power	x1	32R
Phase reversal detection	x1	-

Engine protections

Protections	No. of	ANSI
Under-speed	x1	14
Over-speed	x1	12
Configurable crank connect	x1	-
Battery monitoring	x1	-
Charging alternator	x1	-
Pre-heat	x1	-
Coolant temperature	x1	-
Lube oil pressure	x1	-
Fuel level detection	x1	-
Fuel theft detection	x1	-
ECU communication failure	x1	-
ECU diagnostic lamps	x1	-

Mains protections

Protections	No. of	ANSI
Under-voltage	x1	27P
Over-voltage	x1	59
Under-frequency	x1	81U
Over-frequency	x1	81O
Phase reversal detection	x1	-

2. Technical specifications

2.1 Electrical specifications

2.1.1 Power supply

Category	Specification
Controller terminals	1 (Ground) 2 (Battery or DC+)
Supply voltage range	Nominal voltage: 12/24 V DC Operating range: 8 to 28 V DC
Cranking dropout period	50 ms
Maximum reverse voltage protection	-32 V DC
Measurement accuracy (battery voltage)	±1 % full scale
Resolution	0.1 V
Maximum current consumption	~ 200 mA, 12/24 V DC (excluding the current load for the DC)
Standby current consumption (LCD backlight off)	124 mA, 12 V DC 123 mA, 24 V DC
Deep sleep current	20 mA, 12/24 V DC

2.1.2 Genset voltage and frequency measurements

Category	Specifications
Controller terminals	27 (Neutral) 28 (L3) 29 (L2) 30 (L1)
Measurement type	True RMS
Phase-to-neutral voltage	32 to 300 V AC RMS
Phase-to-phase voltage	32 to 520 V AC RMS
Voltage accuracy	±1 % of full scale for phase-to-neutral ±2 % of full scale for phase-to-phase
Voltage resolution	1 V AC RMS for phase-to-neutral 2 V AC RMS for phase-to-phase
Frequency range	5 to 75 Hz
Frequency accuracy	0.25 % of full scale
Frequency resolution	0.1 Hz

NOTE For single phase applications, it is mandatory to connect:

- The genset phase (L1) to terminal 30 on the controller.
- The genset neutral to terminal 27 on the controller.

2.1.3 Genset current measurements

Category	Specifications
Controller terminals	39 and 40 (for phase L1) 37 and 38 (for phase L2) 35 and 36 (for phase L3)
Measurement type	True RMS
Maximum CT secondary current rating	Nominal: -/5 A CT
Burden	0.25 VA
Measurement accuracy	±1.4 % of nominal

NOTE Use the recommended phase sequence when you connect the current transformer (CT).

2.1.4 Mains voltage and frequency measurement

Category	Specifications
Controller terminals	31 (Neutral) 32 (L3) 33 (L2) 34 (L1)
Measurement type	True RMS
Phase-to-neutral voltage	32 to 300 V AC RMS
Phase-to-phase voltage	32 to 520 V AC RMS
Voltage accuracy	±2 % of full scale for phase-to-neutral ±2.5 % of full scale for phase-to-phase
Voltage resolution	1 V AC RMS for phase-to-neutral 2 V AC RMS for phase-to-phase
Frequency range	5 to 75 Hz
Frequency accuracy	0.25 % of full scale
Frequency resolution	0.1 Hz

NOTE For single phase applications, it is mandatory to connect:

- The mains phase (L1) to terminal 34 on the controller.
- The mains neutral to terminal 31 on the controller.

2.1.5 Digital inputs

Category	Specifications
Controller terminals	10, 11, 12, 21, 22
Number of inputs	5
Type	Negative switching
Maximum input voltage	+32 V
Minimum input voltage	-24 V
Current source	2.42 mA to 7.27 mA (depends on the battery voltage)
Configurable parameters with software	For example, high water temperature and switch to measure if the lube oil pressure is low (LLOP) switch.

2.1.6 Analogue resistive sensor inputs

Category	Specifications
Controller terminals	24 (Engine temperature) 25 (Fuel level sensor) 26 (Oil pressure)
Number of inputs	3
Type	Ratio-metric sensing
Range	10 to 5000 Ω (terminal 24) 10 to 1000 Ω (terminal 25 and 26)
Open circuit detection	Above 1.5 k Ω (terminal 24) Above 5.5 k Ω (terminal 25 and 26)
Measurement accuracy	± 2 % of full scale (up to 1000 Ω)
Connection method	Connect the sensor output terminals between the genset controller terminal and the battery ground terminal.

2.1.7 Analogue voltage/current input

Category	Specifications
Controller terminal	23
Measurement type	Analogue voltage/current sensing
Range	0 to 5 V DC 4 to 20 mA
Accuracy	± 2 % of full scale voltage ± 1.25 % of full scale current
Resolution	0.1 V 0.1 mA

2.1.8 Analogue inputs used as digital inputs

You can use analogue inputs as digital inputs. See **Analogue inputs used as digital inputs** in the **SGC 120 User manual** for how to wire the analogue inputs and the correct settings.

2.1.9 Magnetic pickup (MPU)/W-point frequency input

Category	Specifications
Controller terminal	42
Measurement type	Single ended
Frequency range	10 Hz to 10 kHz
Input voltage range	200 mV to 45 V AC RMS

The magnetic pickup (MPU) is an inductive sensor. It is installed on the engine flywheel, and is used for engine speed sensing. The output of the MPU is a sine-wave signal.

2.1.10 D+ charger alternator

Category	Specifications
Controller terminal	7
Voltage range	0 to V_{BATT} $V_{BATT} = 8$ to 28 V DC
Excitation	PWM (power limited to 3 W, 12 V/250 mA)
Accuracy	± 1 % of full scale

The charge fail is a combined input and output terminal. When the genset starts, the terminal provides controlled power output to excite the charging alternator. After excitation, the controller monitors the output voltage of the charging alternator. You can configure the action for charge fail.

2.1.11 Sensor common point

Category	Specifications
Controller terminal	41
Range	± 2 V
Accuracy	± 2 % of full scale

Connect terminal 41 (SCP) to a solidly grounded point on the engine, for example the engine frame. Do not share the cable used for this connection with other electrical connections.

2.1.12 Communication ports

Category	Specifications
USB	USB 2.0 type B for connection to PC with DEIF Smart connect software.
RS-485 Serial Port	Half duplex Max. baud rate: 115200 bps Data connection: 2-wire Termination resistor of 120 Ω between output terminals A and B (internally mounted) Bus-pin fault protection: max. ± 70 V Maximum distance of line: 200 m Common-mode operating range
Controller terminals for RS-485	15 and 16
CAN	Baud rate: 250 kbps Packet size: 8 bytes Termination resistor of 120 Ω is provided
Controller terminals for CAN	13 and 14

Recommended cable: Belden 3105A or equivalent, 24 AWG (0.5 mm²) twisted pair, shielded, impedance 120 Ω , <40 m Ω /m, min. 95% shield coverage.

2.1.13 Digital outputs

Category	Specifications
Controller terminals	3, 4, 5, 6, 8, 9
Number of outputs	6
Type	DC outputs
Maximum current rating	Max. per output: 500 mA Total max.: 1 A
Software configurable parameters	For example, start relay and fuel relay.



More information

See **Configurable parameters** in the **User manual** for how to configure the parameters.

Do not connect the starter motor relay and the stop solenoid directly to the output terminals on the controller.

Protect the breaker relays for the genset and mains against 4 kVA surges as described by the IEC-61000-4-5 standard.

2.2 Environmental specifications

Operation conditions	
Operating temperature	-20 to +65 °C (-4 to +149 °F). To IEC 60068-2-1, 2
Storage temperature	-30 to +75 °C (-22 to +167 °F). To IEC 60068-2-1, 2
Vibration	2G in X,Y and Z axes for 8 to 500 Hz. To IEC 60068-2-6
Shock	15 g for 11 ms. To IEC 60068-2-27
Humidity	0 to 95 % RH. To IEC 60068-2-78
Protection degree	IP65 (front of module when installed into the control panel with the supplied sealing gasket). To IEC 60529
EMI/EMC	IEC 61000-6-2, 4

2.3 Terminals

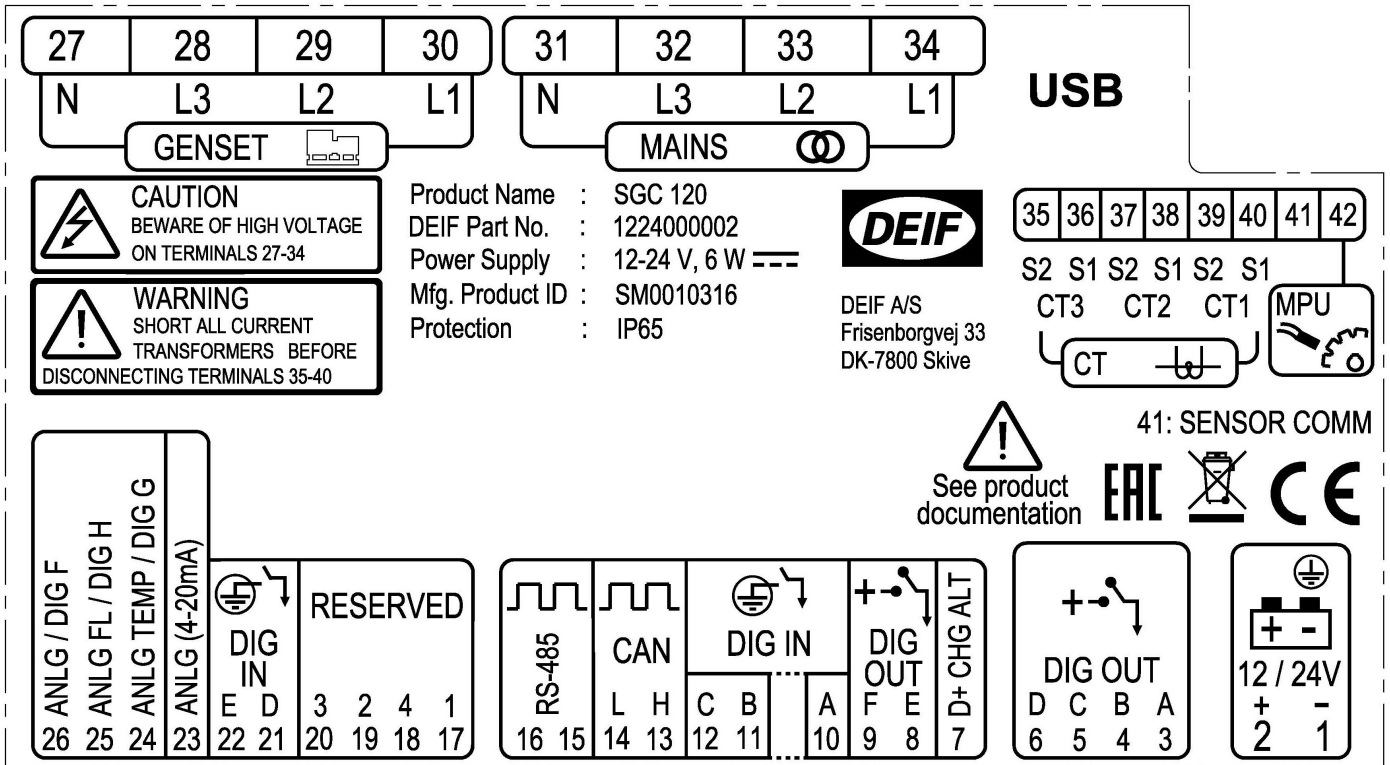

Terminal	Text	Description
1	GND	Power ground
2	BATT +	Power supply positive
3	DIG OUT A	DC output - A
4	DIG OUT B	DC output - B
5	DIG OUT C	DC output - C
6	DIG OUT D	DC output - D
7	D+ CHG ALT	Input for charging alternator control
8	DIG OUT E	DC output - E
9	DIG OUT F	DC output - F
10	DIG IN A	Input from switch A
11	DIG IN B	Input from switch B
12	DIG IN C	Input from switch C
13	CAN H	CAN high
14	CAN L	CAN low
15	RS-485 B	RS-485 B
16	RS-485 A	RS-485 A
17	Reserved	-
18	Reserved	-
19	Reserved	-
20	Reserved	-
21	DIG IN D	Input from switch D

Terminal	Text	Description
22	DIG IN E	Input from switch E
23	ANLG (4 - 20 mA)	Analogue input 4 to 20 mA
24	ANLG TEMP/DIG G	Analogue input from the engine temperature sensor
25	ANLG FL/DIG H	Analogue input from the fuel level sensor
26	ANLG/DIG F	Analogue input from the sensor for the lube oil pressure
27	GENSET N	Voltage input from generator neutral
28	GENSET L3	Voltage input from generator phase L3
29	GENSET L2	Voltage input from generator phase L2
30	GENSET L1	Voltage input from generator phase L1
31	MAINS N	Voltage input from mains neutral
32	MAINS L3	Voltage input from mains phase L3
33	MAINS L2	Voltage input from mains phase L2
34	MAINS L1	Voltage input from mains phase L1
35	CT3 S2	CT input 2 from generator phase L3
36	CT3 S1	CT input 1 from generator phase L3
37	CT2 S2	CT input 2 from generator phase L2
38	CT2 S1	CT input 1 from generator phase L2
39	CT1 S2	CT input 2 from generator phase L1
40	CT1 S1	CT input 1 from generator phase L1
41	SENSOR COMM	Sensor common point
42	MPU	MPU input

2.4 Approvals

Standards	
CE	EU Low Voltage Directive: EN 61010-1 Safety requirements for electrical equipment for measurement, control, and laboratory use - Part 1: General requirements EU EMC Directive: EN 61000-6-2, 4
UL	UL/ULC Recognized to UL/ULC6200:2019 1st edition

2.5 Dimensions

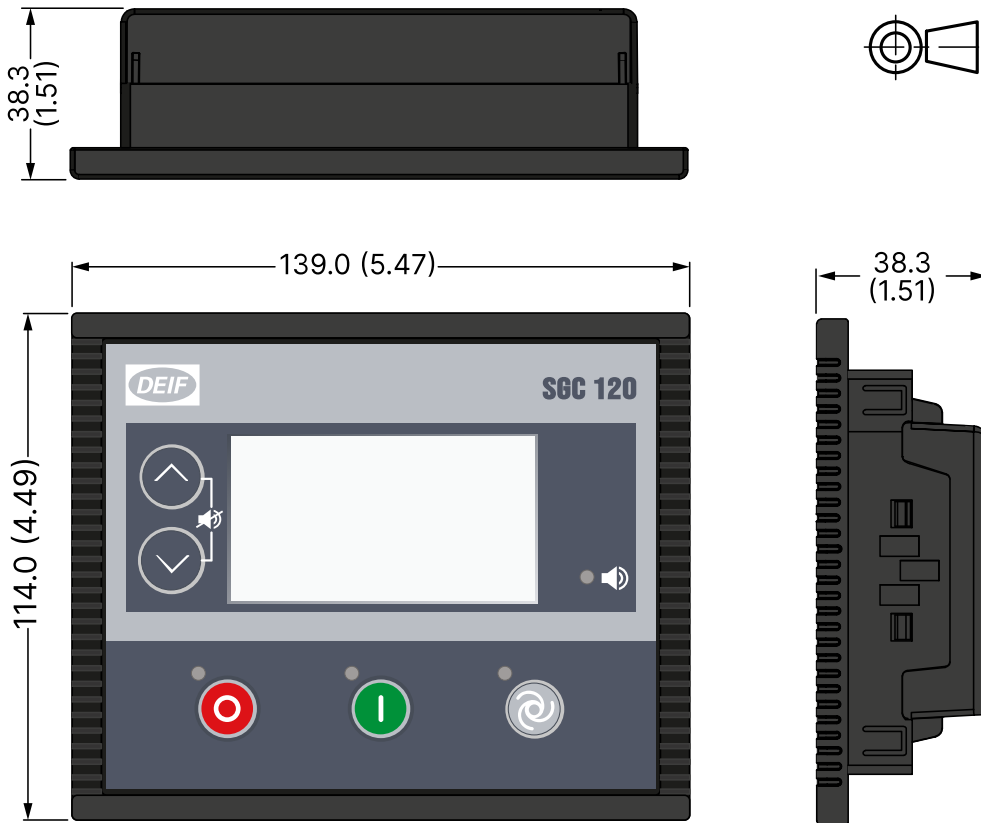

	Length	Height	Depth
Controller	139.0 mm (5.47 in)	114.0 mm (4.49 in)	38.3 mm (1.51 in)
Panel cut-out	118.0 mm (4.65 in)	93.0 mm (3.66 in)	Tolerance: ± 0.3 mm (0.01 in)

3. Legal information

Warranty

NOTICE



Warranty

The controller is not to be opened by unauthorised personnel. If opened anyway, the warranty will be lost.

Disclaimer

DEIF A/S reserves the right to change any of the contents of this document without prior notice.

The English version of this document always contains the most recent and up-to-date information about the product. DEIF does not take responsibility for the accuracy of translations, and translations might not be updated at the same time as the English document. If there is a discrepancy, the English version prevails.

Copyright

© Copyright DEIF A/S. All rights reserved.