

iE 250

Power to create every solution

A versatile and modular-designed Intelligent energy controller. Enables you to tailor the installation to your own needs.

An extensive range of control, protection, and supervision features. Applications range from genset control and protection to engineered Power management solutions with our market-leading fuel optimisation technology.

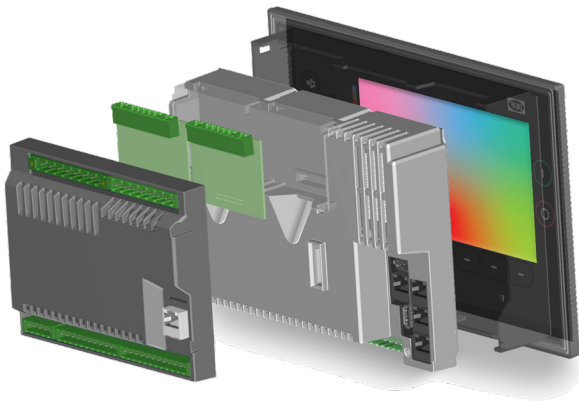

Software packages

Build a software package with only the features you need.

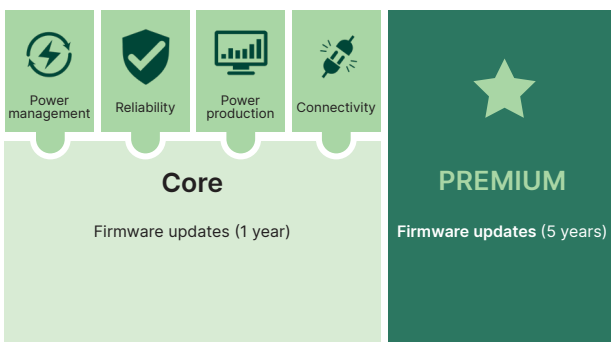

4189341328-F

Main values

Easy and user-friendly interface

- Easy control with flexible dashboards
- Adaptive mimics
- Configurable buttons
- 7" colour touch screen that can be used in combination with buttons

Support for existing applications

- Power management compatibility with other AGC controllers from DEIF

New design - Easy to mount

- Same cut-out as the DEIF iE 150

Event log

- The controller stores up to 2000 log entries and discards the oldest using FIFO when full.

PLC functions

- Programmable functions with CustomLogic
- CODESYS add-on available

Fast short-cut button

- Configurable shortcut feature gives the user easy access to frequently used functions.

Stage V and Tier 4 final support

- iE 250 can communicate with the latest Tier 4 Final engines and show values requested by Stage V.

Flexible

- Modular build-up
- Base mount or front mount
- Plug-in modules
- Bi-directional inputs/outputs

Flexible product

Flexible adaptive mimic

The latest generation of adaptive mimic allows the controller to adapt to any application.

GENSET controller application

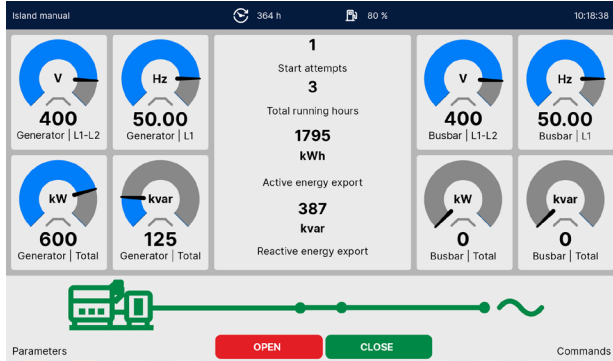

GENSET with MAINS controller application

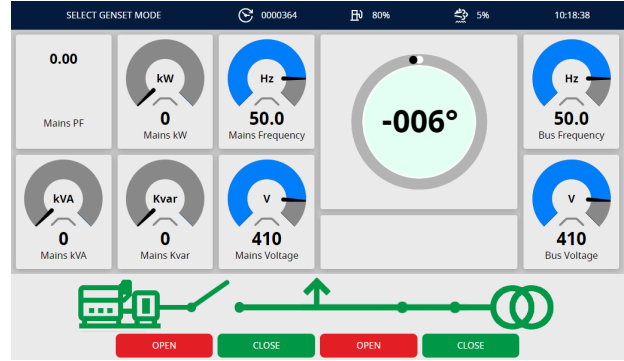

Mount anywhere

A truly flexible approach to how and where you can mount the controller with or without display.



Front-mounted
Display and controller easily installed at the front



Base-mounted with display
Mount the controller at the base and the display located further away.



Base-mounted
Mount the controller at the base.

Extensive input/output possibilities

Direct plug-in input/output modules and expansion slots.

- Plug-in-modules
- Digital I/O (8 bi-directional channels)
 - Analogue I/O (4 bi-directional channels)

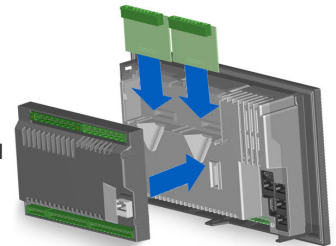

Measurement Input and Output module (MIO) has bidirectional digital and analogue terminals. Smart flexibility allows you to use them for what you need.

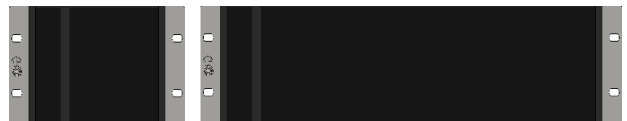

Full support for the range of iE 650 racks and modules when used with CODESYS.

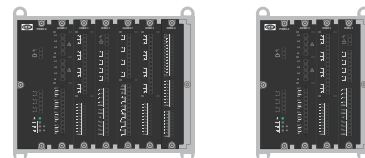

Full support for the Series 300 racks R4.1 and R7.1 with a range of IOM3.x modules.

Easy to use

Easy control

Flexible control for faster and easier operation

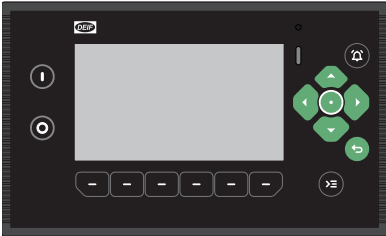

6-way navigation

Button navigation for control, selection, and entering information

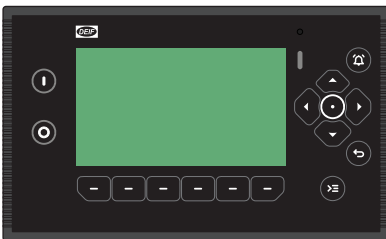

Touch screen

Easy to use touch interface for most functions. This feature can also be disabled.

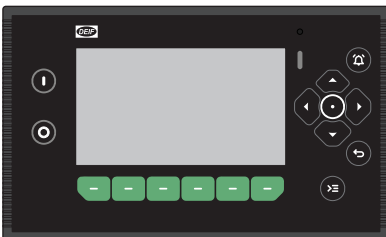

Configurable buttons

Six configurable buttons, allow direct functions from pages.

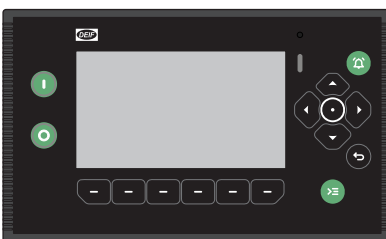

Dedicated buttons

Dedicated buttons for start, stop of the asset, Notification centre and Control centre.

Flexible dashboards

Easy to change dashboards to fit your own needs

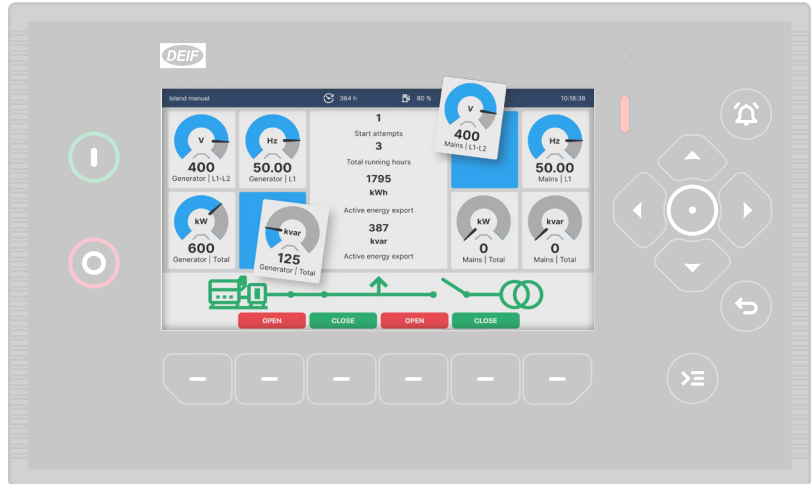

Modern user interface

Fast, easy to use, and intuitive navigation system



Cybersecurity

Cybersecurity conforms to IEC 62443 and protects your controller from unwanted access.

Dimensions and technical specifications

Front-mounted

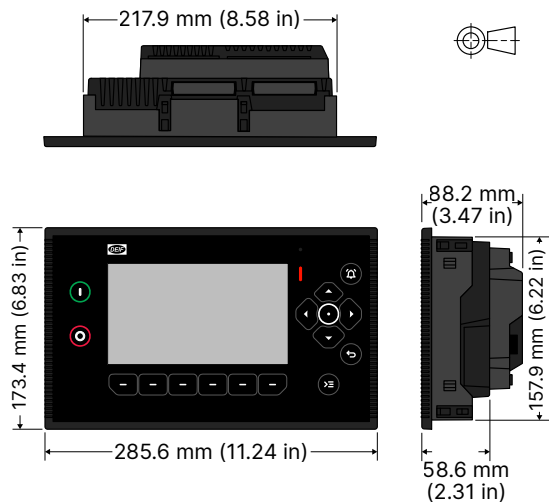

Rear-mounted

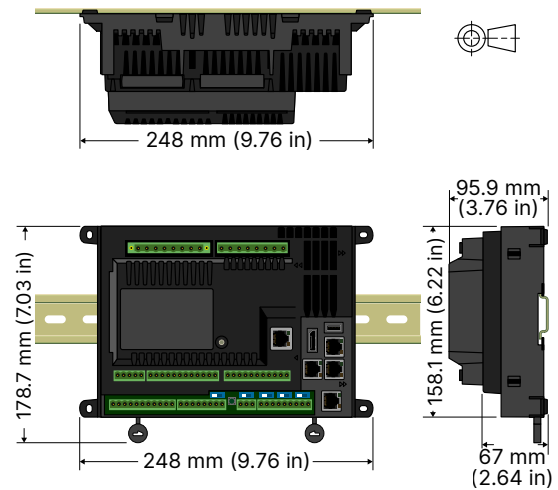

Power supply

- Power supply voltage (nominal): 12 V DC or 24 V DC
- Power supply voltage (operating): 6.5 V DC to 36 V DC
- Load-dump protection: Protected according to ISO16750-2 test A
- Power consumption: 15 W typical, 28 W maximum

Operating conditions

- Operating temperature: -30 to +70 °C (-22 to +158 °F)
- Storage temperature: -30 to +80 °C (-22 to +176 °F)

Measuring

- Nominal voltage: 100 to 690 V AC, phase-to-phase
- Voltage measurement range: 5 to 931.5 V AC, phase-to-phase

- Voltage accuracy: Class 0.5
- Nominal current: 1 or 5 A AC from current transformer
- Current measurement range: 0.005 to 20 A AC
- Current accuracy: Class 0.5
- Frequency measurement range: 10 to 75 Hz
- Power accuracy: Class 0.5

Approvals

- Standards: CE, UKCA
- UL/cUL Listed to - UL/ULC6200:2019 1.ed. Controllers for Use in Power Production
- Cybersecurity certificate: IEC 62443

iE 250
Read here

