



## INSTALLATION INSTRUCTIONS



# ASC-4

## Automatic Sustainable Controller



## 1. General information

<b>1.1 Warnings, legal information and safety</b>	<b>4</b>
1.1.1 Symbols for hazard statements	4
1.1.2 Symbols for general notes	4
1.1.3 Legal information and disclaimer	4
1.1.4 Safety during installation and operation	5
1.1.5 Electrostatic discharge awareness	5
1.1.6 Factory settings	5
<b>1.2 About the installation instructions</b>	<b>5</b>
1.2.1 General purpose	5
1.2.2 Intended users	5
1.2.3 Application examples	6

## 2. Mounting

<b>2.1 ASC mounting and dimensions</b>	<b>7</b>
2.1.1 Mounting of the unit	7
2.1.2 Unit dimensions	7
2.1.3 Panel cutout	7
2.1.4 Drilling template in mm (inches)	8
2.1.5 Mounting instructions	9
2.1.6 Tightening torques	9

## 3. Hardware

<b>3.1 Board slot positions</b>	<b>10</b>
<b>3.2 Terminal overview</b>	<b>10</b>
<b>3.3 Terminal strip overview</b>	<b>12</b>
<b>3.4 Input/output lists</b>	<b>14</b>
3.4.1 Slot 1: Power supply	14
3.4.2 Slot 2: Serial communication (standard)	15
3.4.3 Slot 3: 13 digital inputs and 4 relay outputs (standard/M12)	15
3.4.4 Slot 4: 7 digital inputs (option M13.4)	16
3.4.5 Slot 4: Relay outputs (option M14.4)	16
3.4.6 Slot 4: Analogue outputs for inverter control or transducer signals (option E2)	17
3.4.7 Slot 5: AC measuring	17
3.4.8 Slot 6: 7 digital inputs (option M13.6)	17
3.4.9 Slot 6: 4 relay outputs (option M14.6)	18
3.4.10 Slot 6: 4 analogue inputs (option M15.6)	18
3.4.11 Slot 6: Analogue outputs for transducer (option F1)	18
3.4.12 Slot 7: I/O interface card (standard/M4)	19
3.4.13 Slot 8: Serial communication (option H2.8)	20
3.4.14 Slot 8: 7 digital inputs (option M13.8)	20
3.4.15 Slot 8: 4 relay outputs (option M14.8)	20
3.4.16 Slot 8: 4 analogue inputs (option M15.8)	21

## 4. Wiring

<b>4.1 AC connections</b>	<b>22</b>
4.1.1 Neutral line (N)	22
4.1.2 Current transformer grounding	22
4.1.3 Fuses	22
4.1.4 3-phase wiring	22
<b>4.2 DC connections</b>	<b>24</b>

4.2.1 Digital inputs.....	24
4.2.2 Analogue inputs (option M15.X).....	24
4.2.3 External set points.....	25
4.2.4 Multi-inputs (102, 105, 108).....	25
4.2.5 Transistor outputs (open collector outputs).....	26
<b>4.3 Communication.....</b>	<b>27</b>
4.3.1 CAN bus.....	27
4.3.2 Modbus (option H2.2 and H2.8).....	28
4.3.3 Display cable (option J).....	29

# 1. General information

## 1.1 Warnings, legal information and safety

### 1.1.1 Symbols for hazard statements



#### **DANGER!**



**This highlights dangerous situations.**

If the guidelines are not followed, these situations will result in death, serious personal injury, and equipment damage or destruction.



#### **WARNING**



**This highlights potentially dangerous situations.**

If the guidelines are not followed, these situations could result in death, serious personal injury, and equipment damage or destruction.



#### **CAUTION**



**This highlights low level risk situation.**

If the guidelines are not followed, these situations could result in minor or moderate injury.

#### **NOTICE**

**This highlights an important notice**

Make sure to read this information.

### 1.1.2 Symbols for general notes

**NOTE** This highlights general information.



#### **More information**

This highlights where you can find more information.



#### **Example**

This shows an example.



#### **How to ...**

This gives a link to a video for help and guidance.

### 1.1.3 Legal information and disclaimer

DEIF takes no responsibility for installation or operation of the generator set or switchgear. If there is any doubt about how to install or operate the engine/generator or switchgear controlled by the Multi-line 2 unit, the company responsible for the installation or the operation of the equipment must be contacted.

**NOTE** The Multi-line 2 unit is not to be opened by unauthorised personnel. If opened anyway, the warranty will be lost.

## **Disclaimer**

DEIF A/S reserves the right to change any of the contents of this document without prior notice.

The English version of this document always contains the most recent and up-to-date information about the product. DEIF does not take responsibility for the accuracy of translations, and translations might not be updated at the same time as the English document. If there is a discrepancy, the English version prevails.

### **1.1.4 Safety during installation and operation**

When you install and operate the equipment, you may have to work with dangerous currents and voltages. The installation must only be carried out by authorised personnel who understand the risks involved in working with electrical equipment.



**DANGER!**



#### **Hazardous live currents and voltages**

Do not touch any terminals, especially the AC measurement inputs and the relay terminals, as this could lead to injury or death.

### **1.1.5 Electrostatic discharge awareness**

Sufficient care must be taken to protect the terminal against static discharges during the installation. Once the unit is installed and connected, these precautions are no longer necessary.

### **1.1.6 Factory settings**

The Multi-line 2 unit is delivered from factory with certain factory settings. These are based on average values and are not necessarily the correct settings for matching the engine/generator set in question. Precautions must be taken to check the settings before running the engine/generator set.

## **1.2 About the installation instructions**

### **1.2.1 General purpose**

These Installation Instructions include hardware information, mounting instructions, terminal strip descriptions, I/O lists and wiring descriptions.

The purpose of this document is to give the user important information to be used in the installation of the controller.

### **NOTICE**

#### **Incorrect wiring**

Read this document before starting to work with the Multi-line 2 unit and the equipment to be controlled. Failure to do this could result in human injury or damage to the equipment.

### **1.2.2 Intended users**

These Installation Instructions are mainly intended for the person responsible for the design and installation. In most cases, this would be a panel builder designer. Naturally, other users might also find useful information in the document.

### 1.2.3 Application examples



#### **More information**

See the **ASC Designer's handbook** for application examples.

## 2. Mounting

### 2.1 ASC mounting and dimensions

#### 2.1.1 Mounting of the equipment

The controller is designed for mounting inside the panel. The DU-2 display can be installed on the panel door and connected to the controller with a display cable.

#### 2.1.2 Dimensions

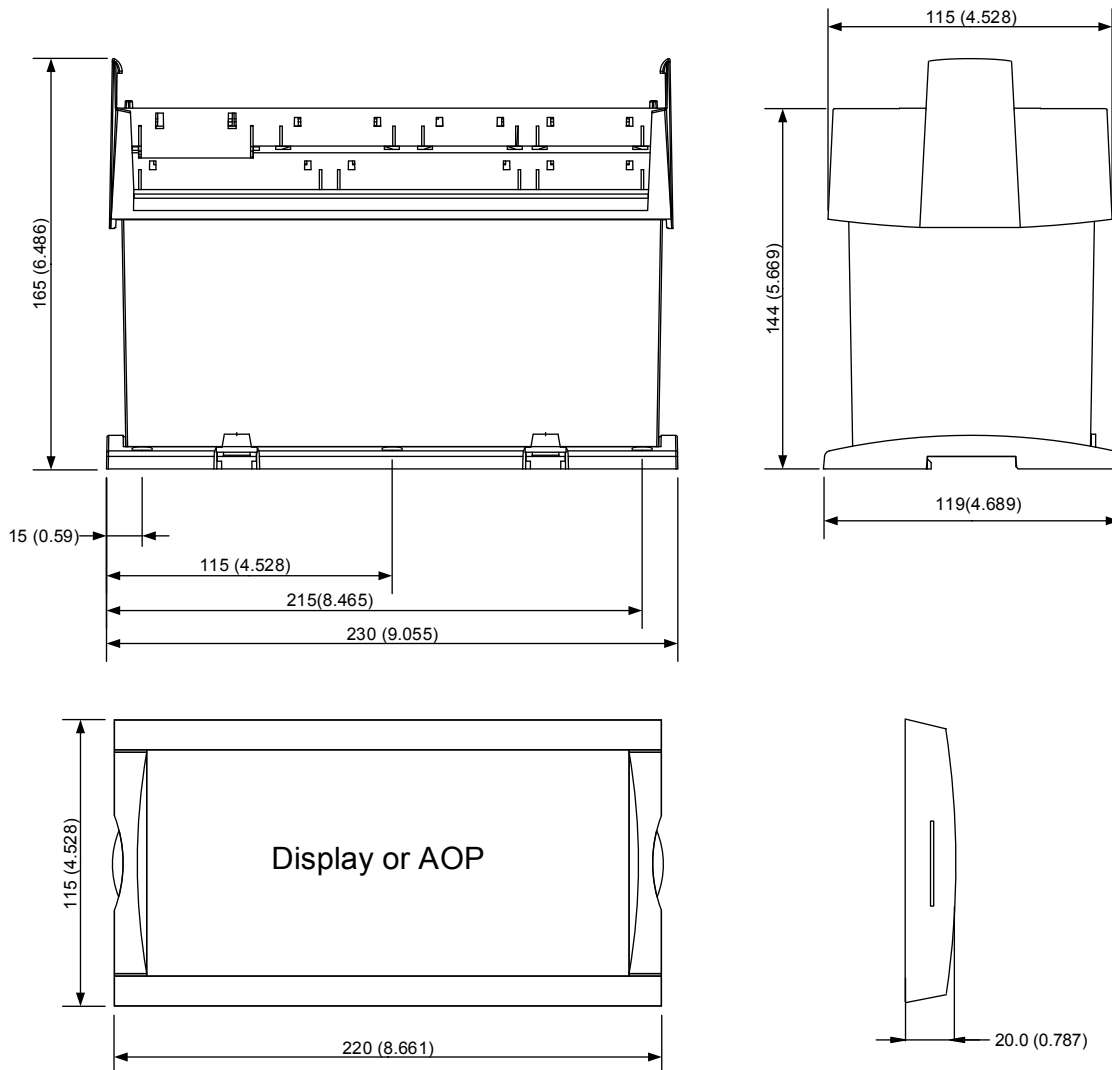

**NOTE** Dimensions are given in mm (inches).

#### 2.1.3 DU-2/AOP display panel cutout

Cut and drill the panel door for the DU-2/AOP according to the diagram below.

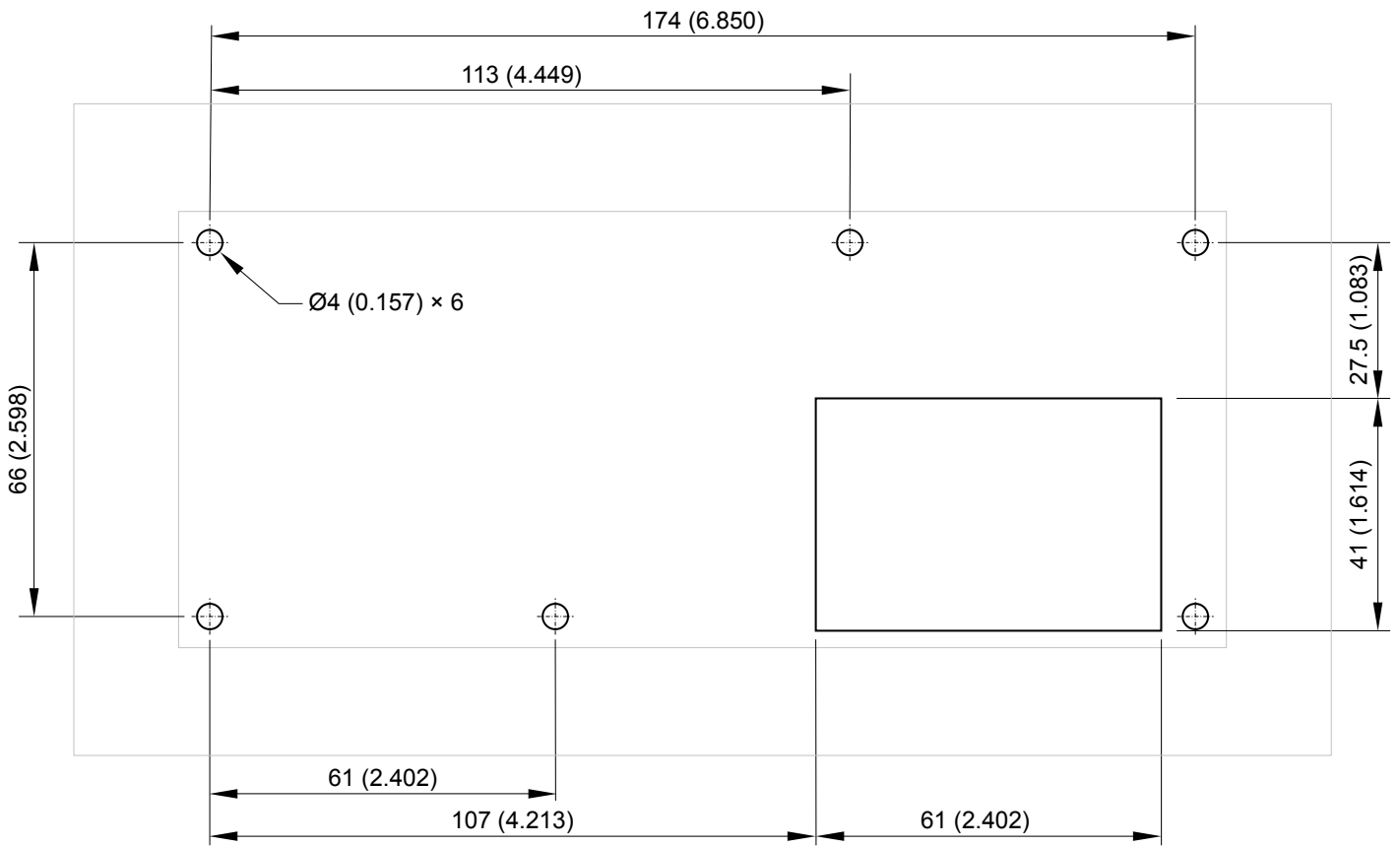

**NOTE** Dimensions are in mm (inches).

## 2.1.4 Controller mounting drilling diagram

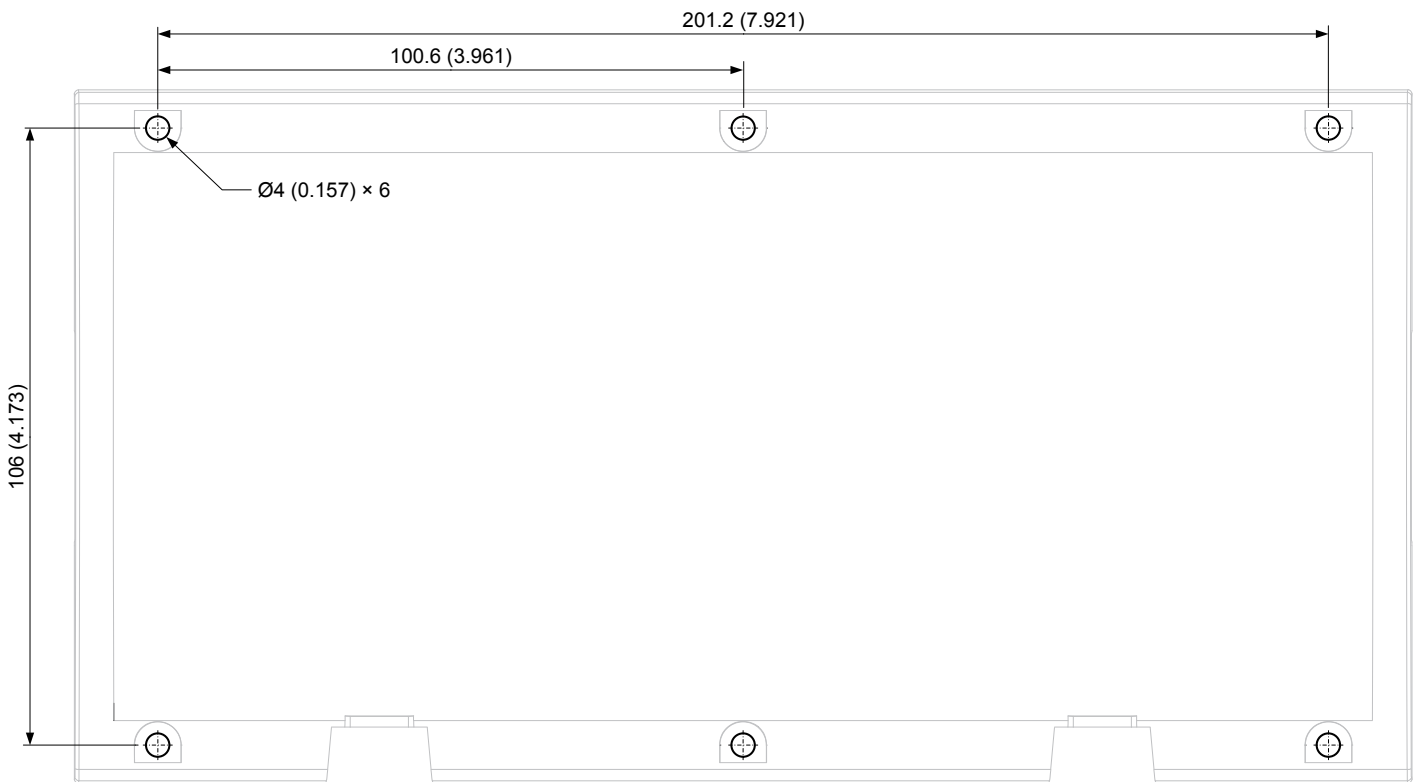

**NOTE** Measurements are in mm (inches).



## 2.1.5 Controller mounting

The controller can be mounted:

1. With screws to the rear side of the cabinet. Six screw holes are available for this.
2. Directly on a DIN rail.

**NOTE** DEIF recommends using the screw hole fastening.

## 2.1.6 Tightening torques

Controller: 1.5 Nm, 13 lb-in for the six M4 screws (countersunk screws are not to be used)

Plug connections (terminals): 0.5 Nm, 4.4 lb-in

DU-2/AOP-1/AOP-2 (see diagram below)

Panel door mounting: 0.7 Nm, 6.2 lb-in

D-sub screw: 0.2 Nm, 1.8 lb-in

DC-DC converter terminals: 0.5 Nm, 4.4 lb-in

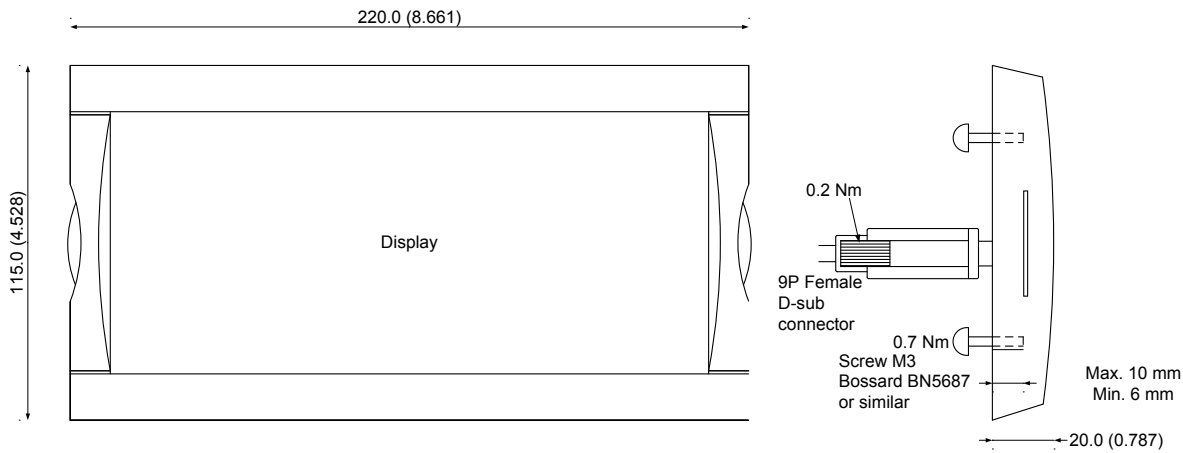

## 3. Hardware

### 3.1 Board slot positions

The controller housing is divided into board slot positions. The controller consists of a number of printed circuit boards (PCBs) mounted in numbered slots. Green terminal blocks are mounted in the PCBs. The board slot positions are as follows.

Slot type	Option	Slot 1	Slot 3	Slot 5	Slot 7
Terminals		1 to 28	37 to 64	73 to 89	98 to 125
Power supply	Standard	X			
AC measurements	Standard			X	
Interface	ASC PM: Standard ASC-4: M4				X
Power management	Standard				X
I/O extension	ASC PM: Standard ASC-4: M12		X		

Slot type	Option	Slot 2	Slot 4	Slot 6	Slot 8
Terminals		29 to 34	65 to 72	90 to 97	126 to 133
Analogue controller outputs	E2		X		
Analogue transducer outputs	F1			X	
Relay outputs	M14.4		X		
Serial communication	H2.2 (standard)	X			
Serial communication	H2.8				X
I/O extension card	M13.4		X		
I/O extension cards	M13.6/M14.6/ M15.6			X	
I/O extension cards	M13.8/M14.8/ M15.8				X

**NOTE** Only hardware options which affect the hardware of the controller are included in the table. The software options can be seen in the data sheet and by using the PC utility software.

### 3.2 Terminal overview

An overview of the terminals is presented below. The slot positions are as follows:

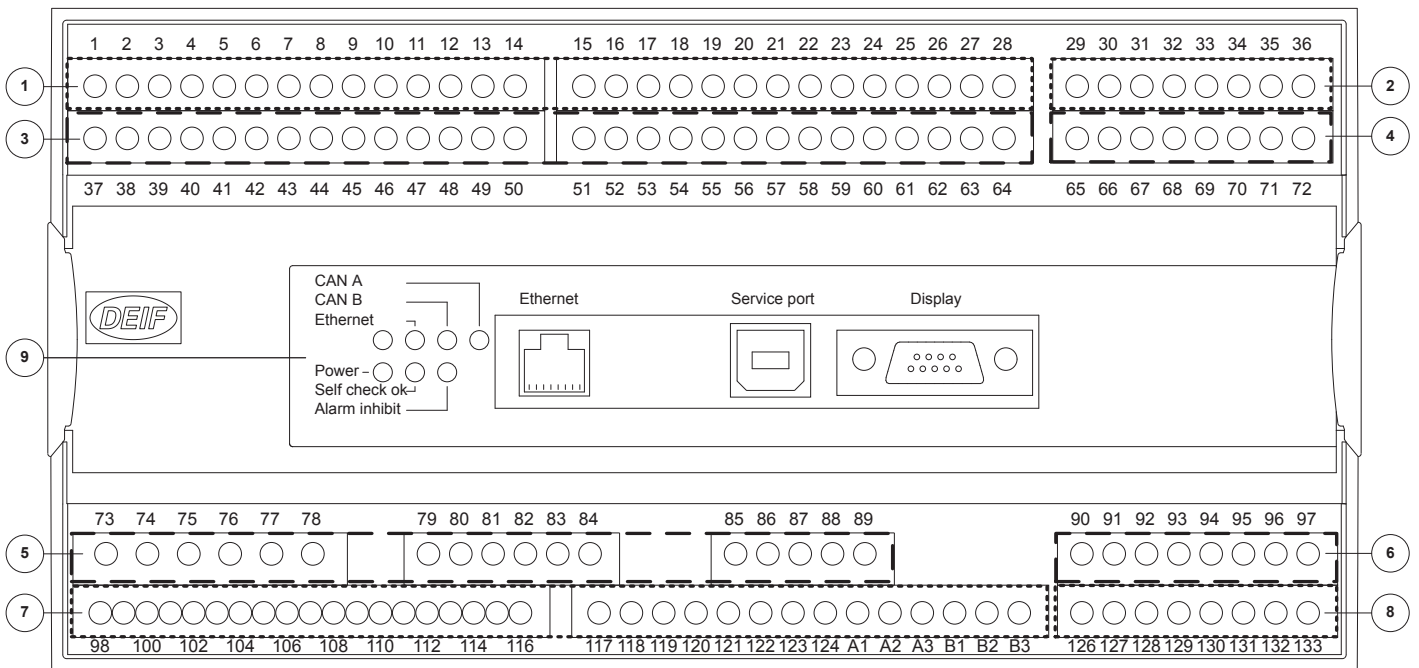

①: The numbers in the drawing above refer to the slot numbers indicated in the table below.

No.	Slot
1	#1, terminal 1-28, power supply (standard)
2	#2, terminal 29-36, communication (standard)
3	#3, terminal 37-64, inputs/outputs (standard/M12)
4	#4, terminal 65-72, inputs/outputs
5	#5, terminal 73-89, AC measuring (standard)
6	#6, terminal 90-97, inputs/outputs
7	#7, terminal 98-125, inputs/outputs and PM CAN (standard/M4)
8	#8, terminal 126-133, communication and I/O extensions
9	LED I/F

### 3.3 Terminal strip overview

Reserved for options, see <i>Data sheet</i> .	36				97	Reserved for options, see <i>Data sheet</i> .	
	35				96		
	34				95		
	33				94		
	32				93		
	31				92		
	30				91		
	29				90		
Common for 23-27	28		Slot #2 Slot #1	Slot #6 Slot #5			
PV/ESS Breaker Closed	27						
PV/ESS Breaker Open	26						
Configurable	25						
Configurable	24						
Configurable	23						
Common for 20/21	22						
kVArh pulse/Relay 21	21						
kWh pulse/Relay 20	20						
Close PV/ESS Breaker (sync.)	19		Relay 17		89	L3	MAINS or BUSBAR VOLTAGE
	18				88	Neutral	
	17				87	L2	
Open PV/ESS Breaker	16		Relay 14	86			
	15			85	L1		
Configurable	13		Relay 11	84	Neutral	PV/ESS VOLTAGE	
	12			83	L3		
	11			82			
Configurable	10		Relay 08	81	L2		
	9			80			
	8			79	L1		
Alarm horn / Configurable	7		Relay 05	78	S2 (l)	L3 AC current	
	6			77	S1 (k)	L3 AC current	
	5						
Status relay	4		Status relay	76	S2 (l)	L2 AC current	
	3			75	S1 (k)	L2 AC current	
DC power supply 8-36 V DC	(-) 2			74	S2 (l)	L1 AC current	
	(+) 1		73	S1 (k)	L1 AC current		

Reserved for options, see <i>Data sheet</i> .	72				133	Reserved for options, see <i>Data sheet</i> .	
	71				132		
	70				131		
	69				130		
	68				129		
	67				128		
	66				127		
	65				126		
		Slot #4	Slot #8				
		Slot #3	Slot #7				
Configurable	64				B3	CAN L	CAN bus Interface1B
	63	Relay 63			B2	GND	
Configurable	62				B1	CAN H	
Configurable	61	Relay 61			A3	CAN L	CAN bus Interface 1
	60				A2	GND	
Configurable	59	Relay 59			A1	CAN H	
Configurable	58				124		Not used
	57	Relay 57			123		
Common for 43-55	56				122		Not used
Configurable	55				121		Not used
Configurable	54				120		Not used
Configurable	53				119		Not used
Configurable	52				118		Emergency stop
Configurable	51				117		Configurable
Configurable	50				116		Configurable
Configurable	49				115		Configurable
Configurable	48				114		Configurable
Configurable	47				113		Configurable
Configurable	46				112		Configurable
Configurable	45				111		Common for 112-117
Configurable	44				110	C	Multi-input 108 or DG reactive
Configurable	43				109	B	
	42				108	A	
Ext. PF set point	41				107	C	Multi-input 105 or DG power
Common for 40/42	40				106	B	
Ext. kW set point	39				105	A	
Not used	38				104	C	Multi-input 102 or MAINS power
Not used	37				103	B	
Not used					102	A	
					101	GND	Not used
					100	Input	
					99	(-)	Common for 118 8-36 V DC
					98	(+)	

## 3.4 Input/output lists

In the I/O lists, the following terms will be used in connection with the relay outputs:

- **NO** means Normally Open
- **NC** means Normally Closed
- **NE** means Normally Energised
- **ND** means Normally Deenergised
- **Com.** means common terminal

### 3.4.1 Slot 1: Power supply

Terminal	Function	Technical data	Description
1	+12/24 V DC	12/24 V DC +/-30 %	Power supply
2	0 V DC		
3	NO	Status relay 24 V DC/1 A	Normally open relay, processor/power supply status supervision
4	Com.		
5	NO	Relay 05 250 V AC/8 A	Central alarm HORN/ Configurable
6	Com.		
7	NC	Relay 08 250 V AC/8 A	Configurable
8	NO		
9	Com.		
10	NC	Relay 11 250 V AC/8 A	Configurable
11	NO		
12	Com.		
13	NC	Relay 14 250 V AC/8 A	Open PV breaker/ESS breaker/ Configurable if there is no breaker
14	NO		
15	Com.		
16	NC	Relay 17 250 V AC/8 A	Close PV breaker/ESS breaker/Configurable if there is no breaker
17	NO		
18	Com.		
19	NC	Transistor output/relay 20 36 V DC, 10 mA	Pulse output 1, kWh counter/ Configurable
20	Open collector 1		
21	Open collector 2	Transistor output/relay 21 36 V DC, 10 mA	Pulse output 2, kvarh counter/ Configurable
22	Com.	Common	Common terminal for terminals 20 and 21
23	Digital input 23	Optocoupler	Configurable
24	Digital input 24	Optocoupler	Mains breaker open feedback/ Configurable if there is no mains breaker
25	Digital input 25	Optocoupler	Mains breaker closed feedback/Configurable if there is no mains breaker

Terminal	Function	Technical data	Description
26	Digital input 26	Optocoupler	PV breaker/ESS breaker open feedback
27	Digital input 27	Optocoupler	PV breaker/ESS breaker closed feedback
28	Com.	Common	Common for terminals 23 to 27

### 3.4.2 Slot 2: Serial communication (standard)

Modbus (standard option H2.2)

Terminal	Function	Description
29*	DATA + (A)	Modbus RTU, RS-485 This is the Modbus master output for inverter control, for example using Sunspec communication
30	GND	
31**	DATA - (B)	
32	Not used	
33*	DATA + (A)	
34	Not used	
35**	DATA - (B)	
36	Not used	

When the serial communication line exceeds 30 m, it should be terminated between DATA + and DATA - with a resistor equal to the cable impedance.

**NOTE** \*Terminals 29 and 33 are internally connected.

**NOTE** \*\*Terminals 31 and 35 are internally connected.

**NOTE** Never connect the GND terminal 30 to earth. Only connect it to the shield in the communication cable.

### 3.4.3 Slot 3: 13 digital inputs and 4 relay outputs (standard/M12)

Terminal	Function	Technical data	Description
37	<b>Not used</b>		
38			
39			
40	-10/+10 V DC	Analogue I/O	f/P set point
41	Com.	Common	Common
42	-10/+10 V DC	Analogue I/O	U/Q set point
43	Digital input	Optocoupler	Configurable
44	Digital input	Optocoupler	Configurable
45	Digital input	Optocoupler	Configurable
46	Digital input	Optocoupler	Configurable
47	Digital input	Optocoupler	Configurable
48	Digital input	Optocoupler	Configurable
49	Digital input	Optocoupler	Configurable

Terminal	Function	Technical data	Description
50	Digital input	Optocoupler	Configurable
51	Digital input	Optocoupler	Configurable
52	Digital input	Optocoupler	Configurable
53	Digital input	Optocoupler	Configurable
54	Digital input	Optocoupler	Configurable
55	Digital input	Optocoupler	Configurable
56	Com.	Common	Common for terminals 43 to 55
57	NE/ND	Relay 57	Configurable
58	Com.	250 V AC/5 A	
59	NE/ND	Relay 59	Configurable
60	Com.	250 V AC/5 A	
61	NE/ND	Relay 61	Configurable
62	Com.	250 V AC/5 A	
63	NE/ND	Relay 63	Configurable
64	Com.	250 V AC/5 A	

#### 3.4.4 Slot 4: 7 digital inputs (option M13.4)

Terminal	Function	Technical data	Description
65	Digital input 65	Optocoupler	Configurable
66	Digital input 66	Optocoupler	Configurable
67	Digital input 67	Optocoupler	Configurable
68	Digital input 68	Optocoupler	Configurable
69	Digital input 69	Optocoupler	Configurable
70	Digital input 70	Optocoupler	Configurable
71	Digital input 71	Optocoupler	Configurable
72	Com.	Optocoupler	Common for terminals 65 to 71

#### 3.4.5 Slot 4: Relay outputs (option M14.4)

Terminal	Function	Technical data	Description
65	NE/ND	Relay 65	Configurable
66	Com.	250 V AC/5 A	
67	NE/ND	Relay 67	Configurable
68	Com.	250 V AC/5 A	
69	Not used	Relay 69	Configurable
70	Com.	250 V AC/5 A	
71	Not used	Relay 71	Configurable
72	Com.	250 V AC/5 A	



### 3.4.6 Slot 4: Analogue outputs for inverter control or transducer signals (option E2)

Terminal	Function	Description
65	Not used	
66	0(4) to 20 mA out	Configurable
67	0	
68	Not used	
69	Not used	
70	0(4) to 20 mA out	Configurable
71	0	
72	Not used	

### 3.4.7 Slot 5: AC measuring

Terminal	Function	Technical data	Description
73	I L1, s1	PV/ ESS current L1	x/1 A or x/5 A input
74	I L1, s2		
75	I L2, s1	PV/ESS current L2	x/1 A or x/5 A input
76	I L2, s2		
77	I L3, s1	PV/ESS current L3	x/1 A or x/5 A input
78	I L3, s2		
79	U L1	PV/ESS voltage L1	Max. 690 V AC phase-phase value
80		Not used	
81	U L2	PV/ESS voltage L2	Max. 690 V AC phase-phase value
82		Not used	
83	U L3	PV/ESS voltage L3	Max. 690 V AC phase-phase value
84	U <sub>NEUTRAL</sub>	PV/ESS voltage neutral	
85	U L1	Mains/bus voltage L1	Max. 690 V AC phase-phase value
86		Not used	
87	U L2	Mains/bus voltage L2	Max. 690 V AC phase-phase value
88	U <sub>NEUTRAL</sub>	Mains/bus voltage neutral	
89	U L3	Mains/bus voltage L3	Max. 690 V AC phase-phase value

### 3.4.8 Slot 6: 7 digital inputs (option M13.6)

Terminal	Function	Technical data	Description
90	Com.	Common	Common for terminals 91 to 97
91	Digital input 91	Optocoupler	Configurable

Terminal	Function	Technical data	Description
92	Digital input 92	Optocoupler	Configurable
93	Digital input 93	Optocoupler	Configurable
94	Digital input 94	Optocoupler	Configurable
95	Digital input 95	Optocoupler	Configurable
96	Digital input 96	Optocoupler	Configurable
97	Digital input 97	Optocoupler	Configurable

### 3.4.9 Slot 6: 4 relay outputs (option M14.6)

Terminal	Function	Technical data	Description
90	NE/ND	Relay 90	Configurable
91	Com.	250 V AC/5 A	
92	NE/ND	Relay 92	Configurable
93	Com.	250 V AC/5 A	
94	NE/ND	Relay 94	Configurable
95	Com.	250 V AC/5 A	
96	NE/ND	Relay 96	Configurable
97	Com.	250 V AC/5 A	

### 3.4.10 Slot 6: 4 analogue inputs (option M15.6)

Terminal	Function	Technical data	Description
90	Analogue input 91 -	Common	Configurable
91	Analogue input 91 +	4 to 20 mA in	
92	Analogue input 93 -	Common	Configurable
93	Analogue input 93 +	4 to 20 mA in	
94	Analogue input 95 -	Common	Configurable
95	Analogue input 95 +	4 to 20 mA in	
96	Analogue input 97 -	Common	Configurable
97	Analogue input 97 +	4 to 20 mA in	

### 3.4.11 Slot 6: Analogue outputs for transducer (option F1)

Terminal	Function	Description
90	Not used	Transducer output
91	0	
92	0 (4) to 20 mA out	
93	Not used	
94	Not used	

Terminal	Function	Description
95	0	Transducer output
96	0 (4) to 20 mA out	
97	Not used	

**NOTE** Option F1 cannot be used for inverter control outputs.

### 3.4.12 Slot 7: I/O interface card (standard/M4)

Terminal	Function	Technical data	Description
98	+12/24 V DC	12/24 V DC +/-30 %	DC power supply
99	0 V DC		
100	NA	-	Not used
101	NA		
102	A	0(4) to 20 mA Digital Pt100 Pt1000 RMI 0 to 40 V DC	Multi-input 1
103	B		4 to 20 mA signal from mains transducer (stand-alone application)
104	C		
105	A		
106	B		4 to 20 mA signal from genset bus total active power transducer (stand-alone application)
107	C		
108	A		
109	B		4 to 20 mA signal from genset bus total reactive power transducer (stand-alone application)
110	C		
111	Com.		Common
112	Digital input 112	Optocoupler	Configurable
113	Digital input 113	Optocoupler	Configurable
114	Digital input 114	Optocoupler	Configurable
115	Digital input 115	Optocoupler	Configurable
116	Digital input 116	Optocoupler	Configurable
117	Digital input 117	Optocoupler	Configurable
118	Digital input 118	Optocoupler	Emergency stop and common for terminals 119 and 120
119	NO	-	Not used
120	NO	-	Not used
121	Com.	-	Not used
122	NO		
123	Com.	-	Not used
124	NO		

Terminal	Function	Technical data	Description
A1	CAN-H		CAN bus interface A
A2	GND		
A3	CAN-L		
B1	CAN-H		CAN bus interface B
B2	GND		
B3	CAN-L		

### 3.4.13 Slot 8: Serial communication (option H2.8)

Terminal	Function	Description
133*	DATA + (A)	Modbus RTU, RS-485 This is the Modbus master output for power meter communication
132	GND	
131**	DATA - (B)	
130	Not used	
129*	DATA + (A)	
128	Not used	
127**	DATA - (B)	
126	Not used	

When the serial communication line exceeds 30 m, it should be terminated between DATA + and DATA - with a resistor equal to the cable impedance.

**NOTE** \*Terminals 129 and 133 are internally connected.

**NOTE** \*\*Terminals 127 and 131 are internally connected.

**NOTE** Never connect the GND terminal 132 to earth. Only connect it to the shield in the communication cable.

### 3.4.14 Slot 8: 7 digital inputs (option M13.8)

Terminal	Function	Technical data	Description
126	Com.	Common	Common for terminals 127 to 133
127	Digital input 127	Optocoupler	Configurable
128	Digital input 128	Optocoupler	Configurable
129	Digital input 129	Optocoupler	Configurable
130	Digital input 130	Optocoupler	Configurable
131	Digital input 131	Optocoupler	Configurable
132	Digital input 132	Optocoupler	Configurable
133	Digital input 133	Optocoupler	Configurable

### 3.4.15 Slot 8: 4 relay outputs (option M14.8)

Terminal	Function	Technical data	Description
126	NE/ND	Relay 126	Configurable
127	Com.	250 V AC/5 A	

Terminal	Function	Technical data	Description
128	NE/ND	Relay 128	Configurable
129	Com.	250 V AC/5 A	
130	NE/ND	Relay 130	Configurable
131	Com.	250 V AC/5 A	
132	NE/ND	Relay 132	Configurable
133	Com.	250 V AC/5 A	

### 3.4.16 Slot 8: 4 analogue inputs (option M15.8)

Terminal	Function	Technical data	Description
126	Analogue input 127 -	Common	Configurable
127	Analogue input 127 +	4 to 20 mA in	
128	Analogue input 129 -	Common	Configurable
129	Analogue input 129 +	4 to 20 mA in	
130	Analogue input 131 -	Common	Configurable
131	Analogue input 131 +	4 to 20 mA in	
132	Analogue input 133 -	Common	Configurable
133	Analogue input 133 +	4 to 20 mA in	

## 4. Wiring

### 4.1 AC connections

The Multi-line 2 unit can be wired up in 1-phase, 2-phase or 3-phase configuration.



#### CAUTION



#### Incorrect wiring

Contact the switchboard manufacturer for accurate information about required wiring for the specific application.

#### 4.1.1 Neutral line (N)

When 3-phase distribution systems are used, the neutral line (N) is only necessary if it is a 3-phase + neutral system. If the distribution system is a 3-phase system without neutral, then leave the terminals 84 and 88 empty.

#### 4.1.2 Current transformer grounding

The current transformer ground connection can be made on s1 or s2 connection, whichever is preferred.

#### 4.1.3 Fuses

Protect the AC voltage measurement cables with 2 A, slow blow fuses.

#### 4.1.4 3-phase wiring

The diagram shows the most important points to wire, and it shows the example where the PV breaker is installed, but this is optional.

# General wiring arrangement

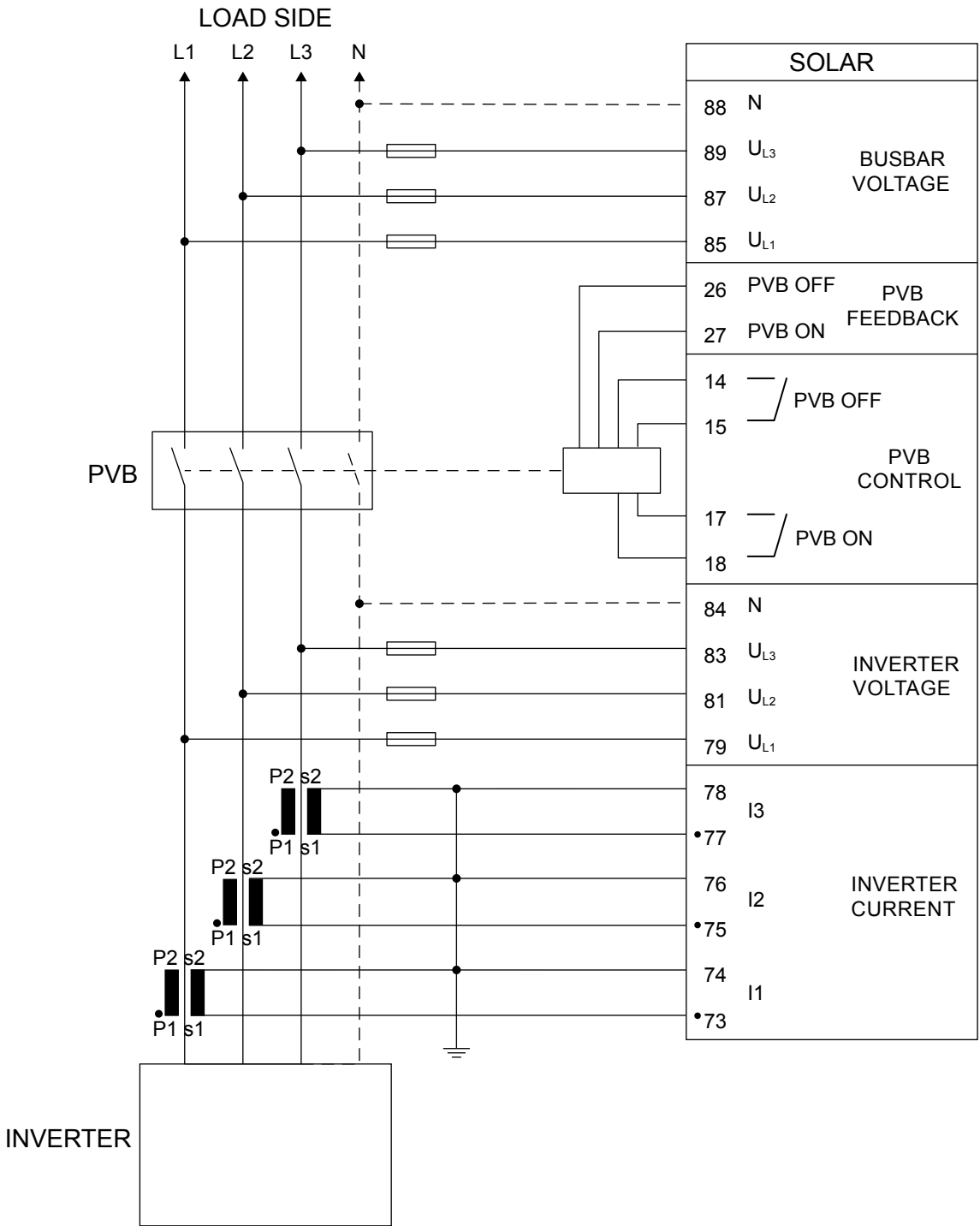

**NOTE** The 3-phase wiring for the ESS is similar to the PV example.

## 4.2 DC connections

### 4.2.1 Digital inputs

#### Battery positive to input

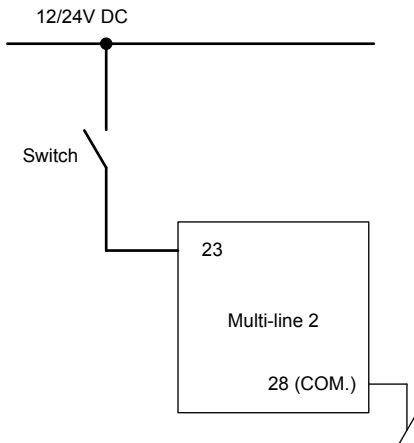

#### Battery negative to input

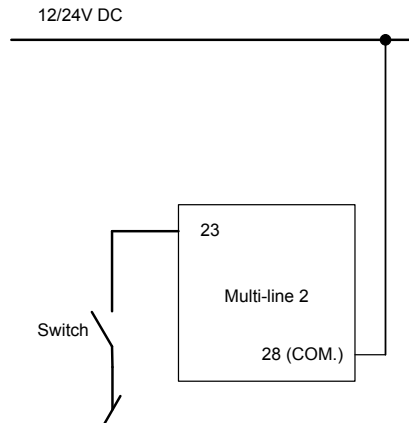

#### Emergency stop

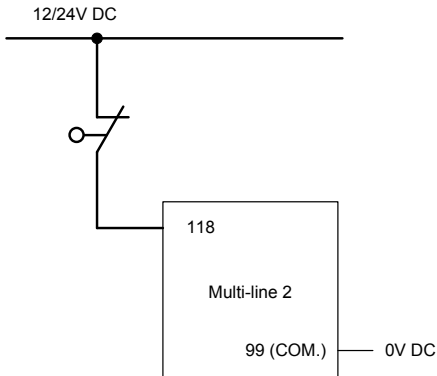

### 4.2.2 Analogue inputs (option M15.X)

#### Active transducer (4 to 20 mA)

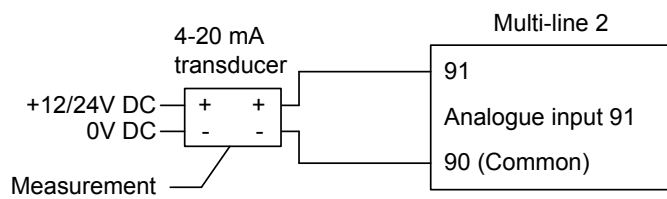

#### Passive transducer (4 to 20 mA)

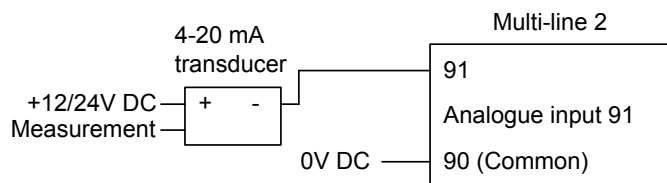



## V DC sensor (4 to 20 mA)

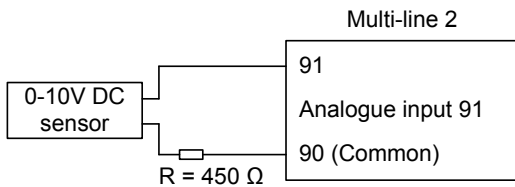

### 4.2.3 External set points

The set point inputs are passive; this means that an external power source is needed. This can be an active output from, for example, a PLC, or a potentiometer can be used.

#### 0 to 10 V DC input using potentiometer

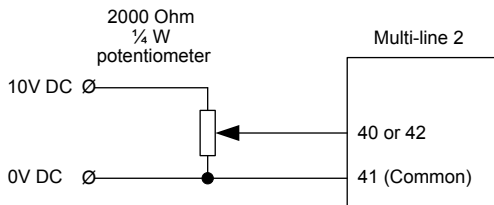

#### +/-10 V DC input using potentiometer

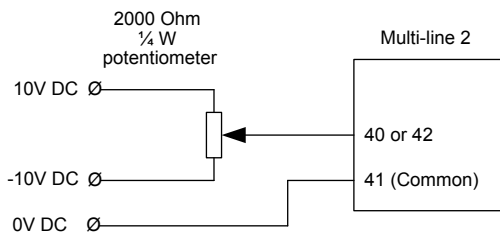

### 4.2.4 Multi-inputs (102, 105, 108)

#### 0(4) to 20 mA

The multi-inputs are placed in slot #7, the terminal numbers for the individual multi-inputs can be seen in the *Input/output list*.

#### Active transducer (0(4) to 20 mA)

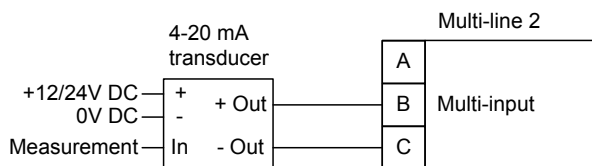

#### Passive transducer (0(4) to 20 mA)

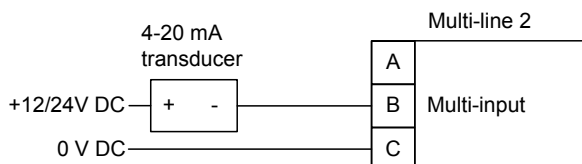

**NOTE** If the passive sensor has its own battery supply, the voltage must not exceed 30 V DC.

## Digital inputs

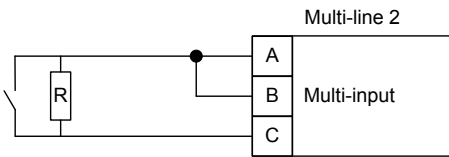

**NOTE** The resistor is only mounted if wire fail supervision is required. The value of the resistor should be  $270 \Omega \pm 10\%$ .

## Pt100/Pt1000

### 2-wire

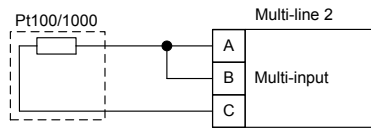

### 3-wire

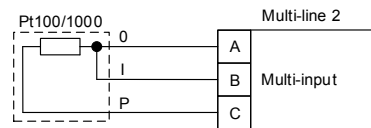

## RMI

### 1-wire

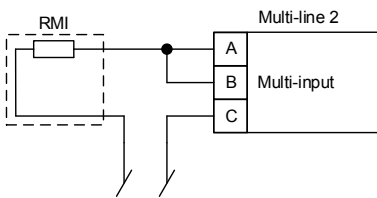

### 2-wire

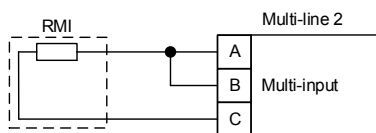

## 0 to 40 V DC

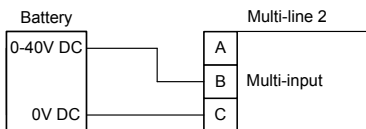

## 4.2.5 Transistor outputs (open collector outputs)

The open collector outputs can be used as kWh and kvarh counter outputs or as relay outputs. The outputs are low power outputs. For that reason, one of the following circuits must be applied.

### External counter

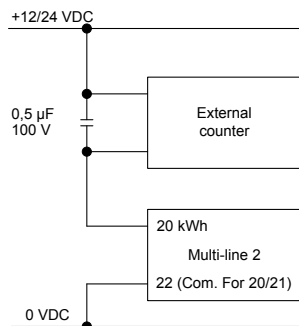

### Relay outputs

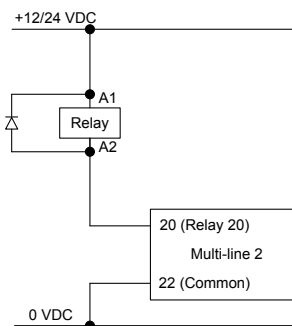

## Connection to PLC

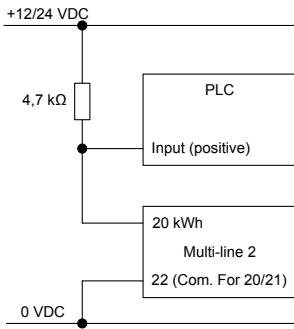

**NOTE** Remember to mount the freewheeling diode.

**NOTE** Maximum load on the open collector outputs is 10 mA at 24 V DC.

## 4.3 Communication

### 4.3.1 CAN bus

Examples with three controllers connected, for example one ASC and two generator AGC controllers.

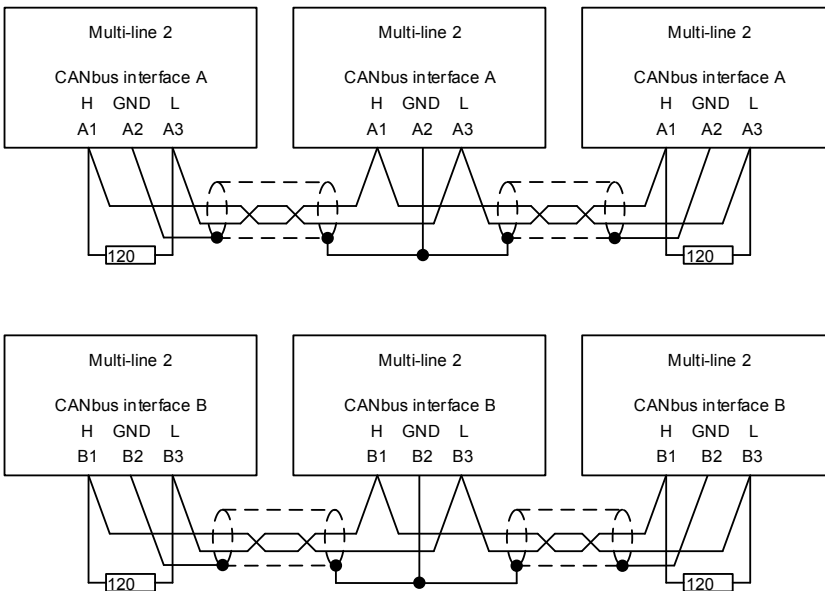

**NOTE** Use shielded twisted cable, Belden 3105A or similar.

**NOTE** End resistor R = 120 Ohm.

## 4.3.2 Modbus (option H2.2 and H2.8)

### Connection with 2-wire screened cable

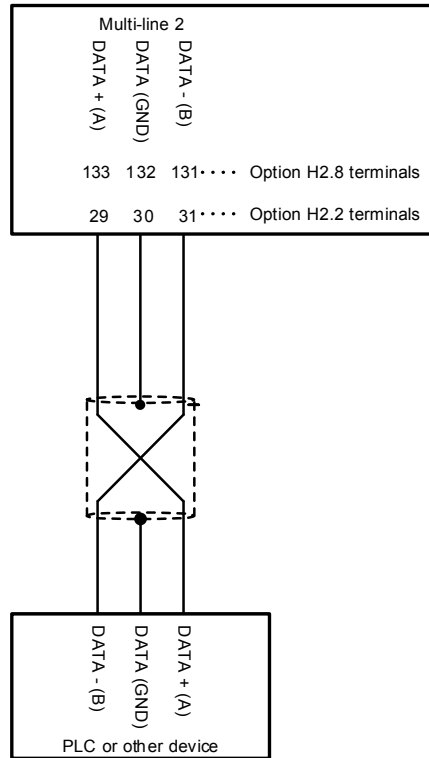

**NOTE** Use shielded twisted cable.

**NOTE** The RS-485 Modbus lines need end resistors (end terminators) when the bus length exceeds 30 m. Install them like this:

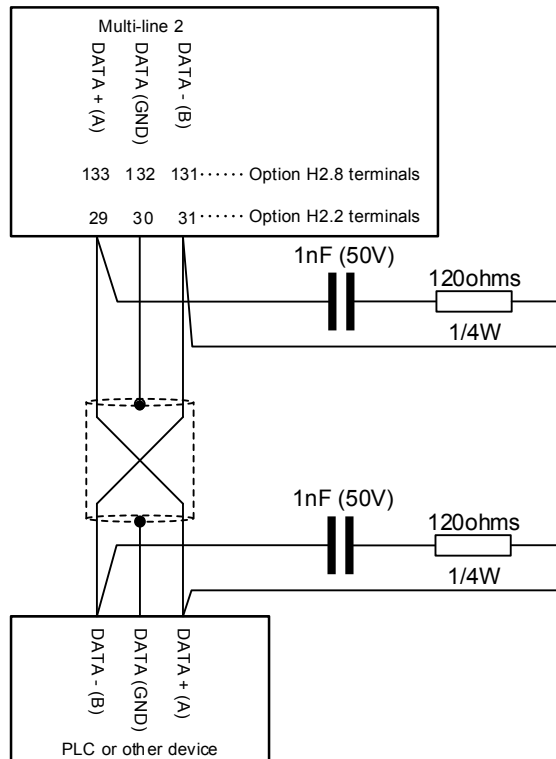

**NOTE** Cable: Belden 3105 A or equivalent. 22 AWG (0.6 mm<sup>2</sup>) twisted pair, shielded, <40 mΩ/m, min. 95 % shield coverage.

### 4.3.3 Display cable (option J)

A standard computer extension cable can be used (9-pole D-sub male/female plugs) or a cable can be tailored.

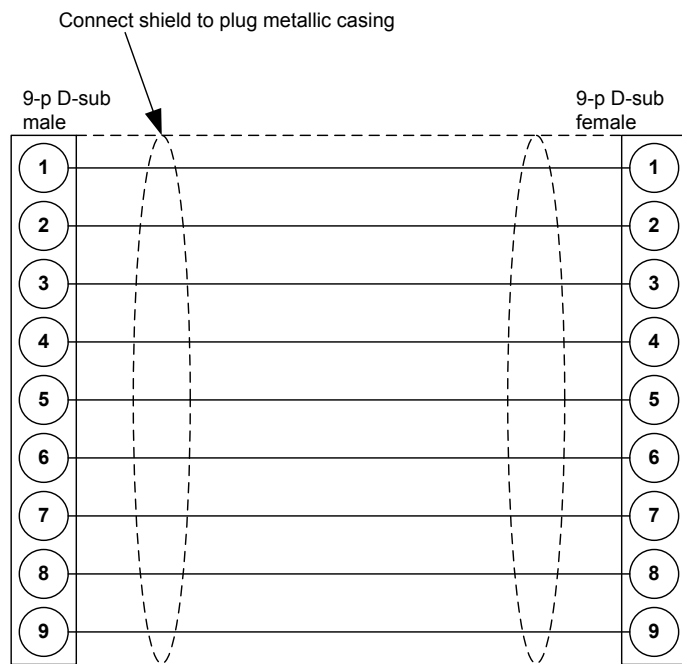

Wires min. 0.22 mm<sup>2</sup>, max. cable length 6 m.

Cable types: Belden 9540, BICC H8146, Brand Rex BE57540 or equivalent.

**NOTE** Do not use tools or brute force when tightening the finger-screws on the display cable.