

MULTI-LINE 2

4189340702H

Option X

Additional display and operator panel



Improve
Tomorrow



1. Delimitation	
1.1 Scope of option X	3
2. General information	
2.1 Warnings, legal information and safety	4
2.1.1 Warnings and notes	4
2.1.2 Legal information and disclaimer	4
2.1.3 Safety issues	4
2.1.4 Electrostatic discharge awareness	4
2.1.5 Factory settings	4
3. Description of option	
3.1 Option X2	5
3.1.1 Rear side view	5
3.1.2 Connectors	5
3.2 Option X3	5
3.2.1 Rear side view	6
3.2.2 Connectors	6
3.3 Option X4	6
3.3.1 Rear side view	6
3.3.2 Connectors	6
4. Function description	
4.1 Additional displays and operator panels	7
4.2 Display unit - DU-2	7
4.2.1 Wiring - cable type 1	7
4.2.2 Wiring - cable type 2	9
4.2.3 End resistor	9
4.2.4 CAN ID configuration	9
4.2.5 Protocol selection	10
4.2.6 Access from primary and secondary DU-2	10
4.3 Additional operator panel - AOP-1	11
4.3.1 Front side view	11
4.3.2 Wiring	11
4.3.3 CAN ID configuration	12
4.3.4 Programming	12
4.4 Additional operator panel - AOP-2	12
4.4.1 Front side view	12
4.4.2 Wiring - cable type 1	12
4.4.3 Wiring - cable type 2	14
4.4.4 End resistor	14
4.4.5 CAN ID configuration	14
4.4.6 Status relay	15
4.4.7 Programming	15
4.4.8 Lamp test/dimmer	15
4.5 Error handling	15
4.5.1 Duplicate CAN ID	15

1. Delimitation

1.1 Scope of option X

This description of options covers the following Multi-line 2 units:

AGC-4 Mk II	SW version 6.0x.x or later
AGC-4	SW version 4.0x.x or later
AGC-3	SW version 3.3x.x or later
GPC-3/GPU-3 Hydro	SW version 3.0x.x or later
PPM	SW version 3.0x.x or later
PPU-3/GPU-3	SW version 3.0x.x or later

2. General information

2.1 Warnings, legal information and safety

2.1.1 Warnings and notes

Throughout this document, a number of warnings and notes with helpful user information will be presented. To ensure that these are noticed, they will be highlighted as follows in order to separate them from the general text.

Warnings



DANGER!

Warnings indicate a potentially dangerous situation, which could result in death, personal injury or damaged equipment, if certain guidelines are not followed.

Notes



INFO

Notes provide general information, which will be helpful for the reader to bear in mind.

2.1.2 Legal information and disclaimer

DEIF takes no responsibility for installation or operation of the generator set. If there is any doubt about how to install or operate the engine/generator controlled by the Multi-line 2 unit, the company responsible for the installation or the operation of the set must be contacted.

NOTE The Multi-line 2 unit is not to be opened by unauthorised personnel. If opened anyway, the warranty will be lost.

Disclaimer

DEIF A/S reserves the right to change any of the contents of this document without prior notice.

The English version of this document always contains the most recent and up-to-date information about the product. DEIF does not take responsibility for the accuracy of translations, and translations might not be updated at the same time as the English document. If there is a discrepancy, the English version prevails.

2.1.3 Safety issues

Installing and operating the Multi-line 2 unit may imply work with dangerous currents and voltages. Therefore, the installation should only be carried out by authorised personnel who understand the risks involved in working with live electrical equipment.



DANGER!

Be aware of the hazardous live currents and voltages. Do not touch any AC measurement inputs as this could lead to injury or death.

2.1.4 Electrostatic discharge awareness

Sufficient care must be taken to protect the terminals against static discharges during the installation. Once the unit is installed and connected, these precautions are no longer necessary.

2.1.5 Factory settings

The unit is delivered from the factory with default settings. These are not necessarily correct for the engine/generator set. Check all the settings before running the engine/generator set.

3. Description of option

3.1 Option X2

The option includes an additional standard display (DU-2) for the ML-2 unit to be connected to the original display unit via a CAN bus connection.

With additional DU-2 units it is possible to operate the system from various positions, for example start/stop, alarm acknowledge, readings, access set points, and so on.



INFO

A maximum of three standard displays can be connected to each ML-2 unit.



INFO

The maximum length of the CAN bus line is 200 m.

3.1.1 Rear side view

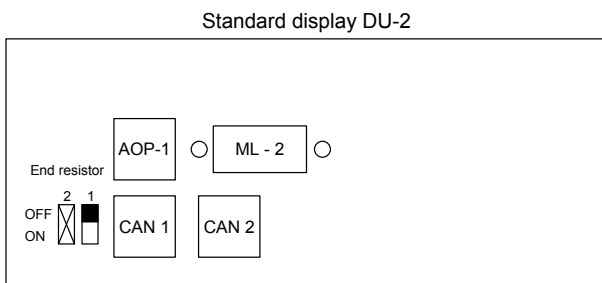

3.1.2 Connectors

ML-2:	The serial connection to/from the display port of the ML-2 unit.
AOP-1:	The connector for the cable to an AOP-1.
CAN 1:	DC supply and CAN bus communication to/from other DU-2 or AOP-2 units.
CAN 2:	CAN bus communication to/from other DU-2 or AOP-2 units.
End resistor:	Dip switch for 120 Ohm end resistor for the CAN bus communication. Dip switch no. 2 is not to be used.

3.2 Option X3

The option includes an additional operator panel (AOP-1) which is to be connected directly to a standard display (DU-2) via a serial communication line, and only one AOP-1 can be connected to each DU-2. The AOP-1 has 16 configurable LEDs and eight configurable buttons, which are programmed with the PC utility software. It can be used as an interface to the ML-2 units for indication of status and alarms together with buttons for alarm acknowledge and mode selection, for example.



INFO

Since a DU-2 is required for each AOP-1, the possible number of AOP-1 units is determined by the number of DU-2 units.



INFO

The maximum distance between the DU-2 and the AOP-1 is 0.5 m.

3.2.1 Rear side view

Additional operator panel AOP-1



3.2.2 Connectors

DU-2: DC power supply and serial communication to/from the DU-2.

3.3 Option X4

This option includes an additional operator panel (AOP-2) which can be connected to the standard display via a CAN bus communication line. The AOP-2 has 16 configurable LEDs and eight configurable buttons, which are programmed with the PC utility software. It can be used as an interface to the ML-2 units for indication of status and alarms together with buttons for alarm acknowledge and mode selection, for example.



INFO

A maximum of five AOP-2 units can be connected to each ML-2 unit.



INFO

The maximum length of the CAN bus line is 200 m.

3.3.1 Rear side view

Additional operator panel AOP-2

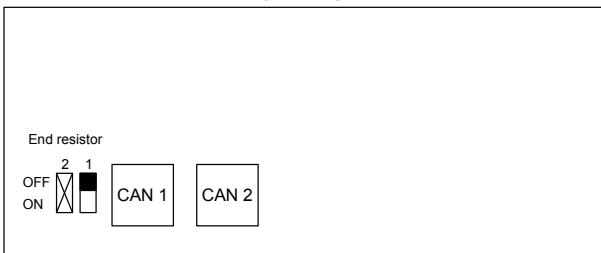

3.3.2 Connectors

CAN 1: DC supply and CAN bus communication to/from other DU-2 or AOP-2 units.

CAN 2: CAN bus communication to/from other DU-2 or AOP-2 units and status relay output.

End resistor: Dip switch for 120 Ohm end resistor for the CAN bus communication.
Dip switch no. 2 is not to be used.

4. Function description

4.1 Additional displays and operator panels

Below is a principle diagram of the connection of the additional displays and operator panels.

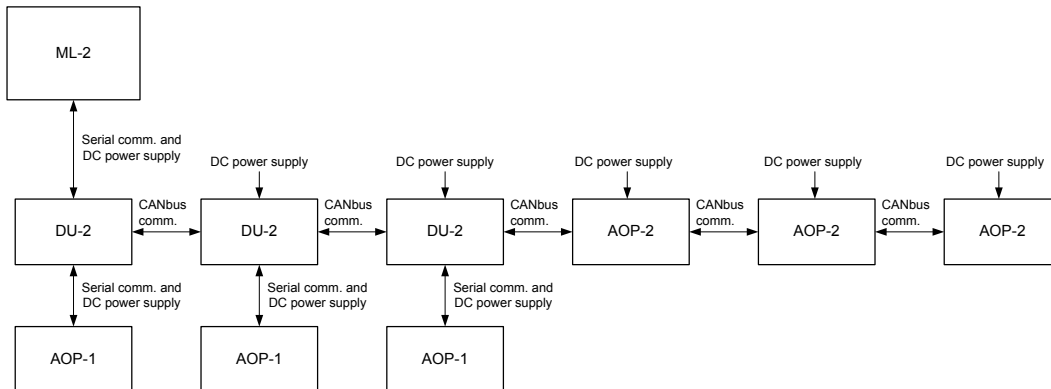

INFO

Only three AOP-2 units are shown in the diagram, but up to five units are supported.

Only one DU-2 has to be connected to the ML-2 unit. The rest of the displays and AOP units are connected to each other with communication lines (serial or CAN bus) and get their information through the DU-2 unit connected to the ML-2 unit.

4.2 Display unit - DU-2

4.2.1 Wiring - cable type 1



INFO

Be aware that two cables can be chosen, and that there is a difference in the colour codes of the wires. The diagrams below show how to wire up both cable types.

Standard display DU-2

Additional standard display DU-2

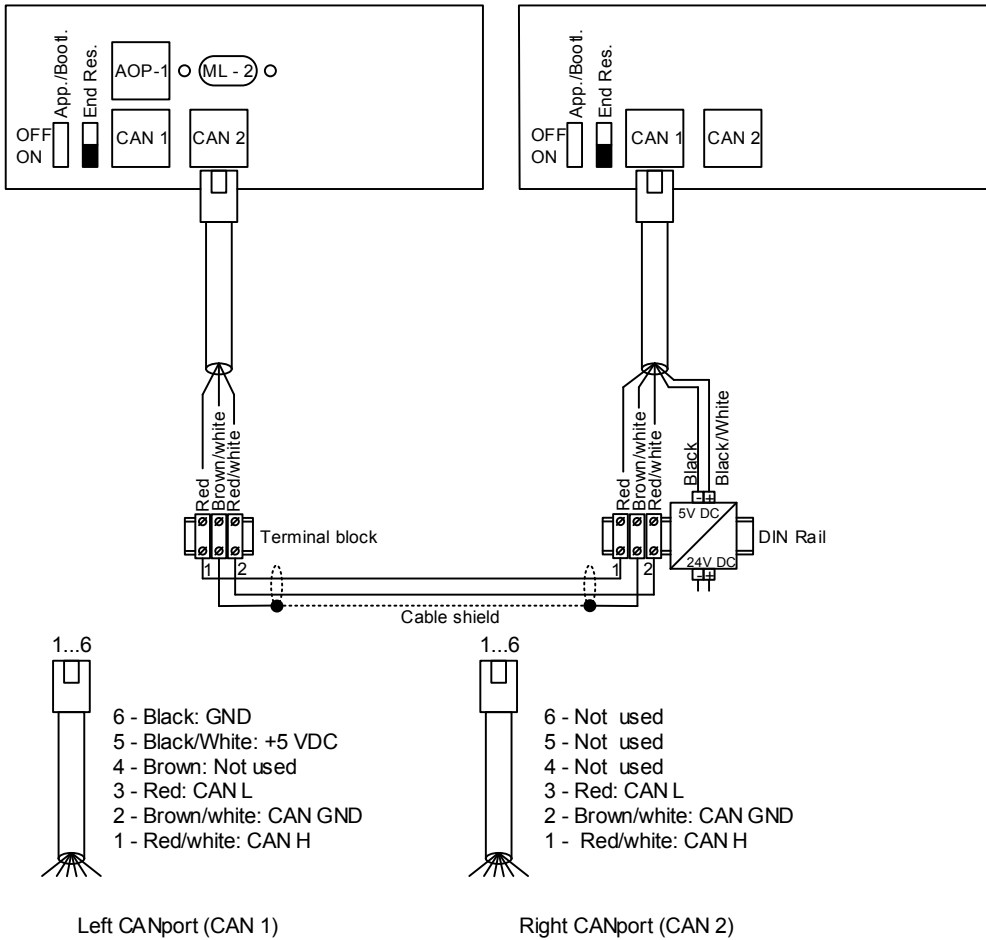

4.2.2 Wiring - cable type 2

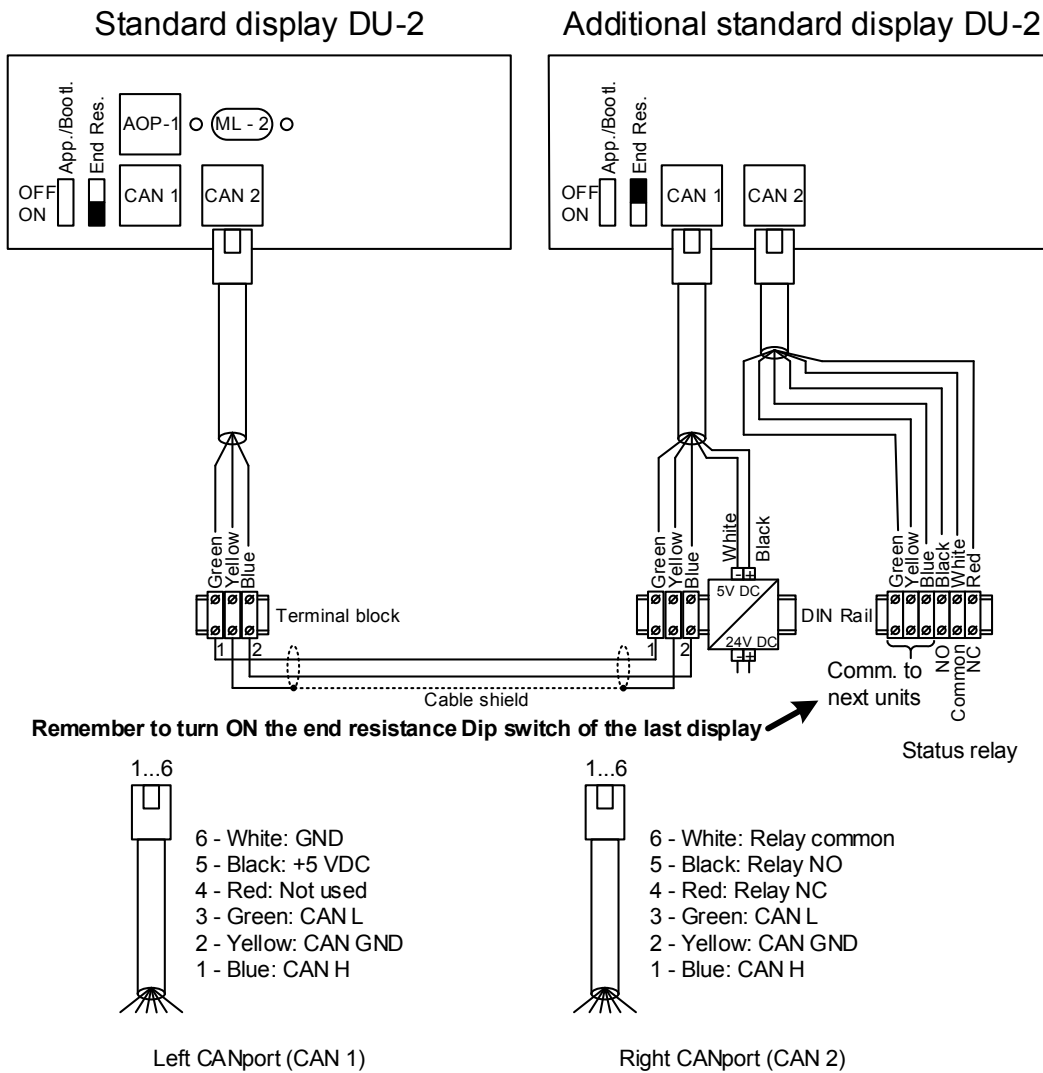

INFO

It is recommended to keep a fair distance to power cables.



INFO

The maximum length of the CAN bus line is 200 m.



INFO

A DC/DC converter for the DC supply voltage and 2 x 1 m cable with an RJ45 plug in one end and stripped wires in the other end are included in the DU-2 delivery.

4.2.3 End resistor

2 units connected:

Dip switch no. 1 has to be set to ON on both units.

3 units connected:

Dip switch no. 1 has to be set to ON on unit 1 and unit 3.





More than 3 units connected:

Dip switch no. 1 has to be set to ON on the first and the last unit on the CAN bus line.

4.2.4 CAN ID configuration

The CAN ID on the DU-2 can be set from 0 to 3. If it is set to zero, the CAN bus communication is deactivated.

The CAN ID selection is done in the following way:

1. On the DU-2, press the left , up  and right  buttons at the same time to activate a CAN ID selection menu.
2. Select the desired CAN ID with the up  and down  buttons and press ENTER.

The CAN ID of the DU-2 has now been selected.



INFO

The DU-2 which is connected to the ML-2 unit has to have CAN ID no. 1.



INFO





If the CAN bus communication to other DU-2 or AOP-2 units are not used, the CAN ID should be set to zero.

4.2.5 Protocol selection

The DU-2 contains three protocols for the data transmission between the ML-2 unit and the display. Normally the protocol is set automatically, however if the display is used with older ML-2 units, it is necessary to choose the protocol which supports these according to the following table.

Protocol	Supports	Comment
1	Std. ML-2 with software version 1.xx.x and 2.xx.x	
2	AGC units with software version 1.xx.x and 2.xx.x PPM units with software version 2.xx.x MDR-2 units with software version 1.xx.x and 2.xx.x	
3	AGC-4 Mk II controllers AGC units with software version 3.xx.x and 4.xx.x GPC/GPU/PPU units with software version 3.xx.x PPM units with software version 3.xx.x	

Change of protocol is done like this:

1. On the DU-2, press the left , ENTER and right  buttons at the same time to activate a protocol selection menu.
2. Select the desired protocol with the up  and down  buttons and press ENTER.

4.2.6 Access from primary and secondary DU-2

The below table describes what can be done from the displays. "Read" means that it is only possible to supervise, for example, parameter settings. "Write" means that it is possible to make changes in, for example, parameter settings.

The drawings in the table show examples of different set-ups. The selection of primary and secondary display is independent of wiring and CAN bus IDs. In this way, any given DU-2 in a set-up can be primary or secondary display.

The table also describes the settings of the CAN bus IDs for the displays.

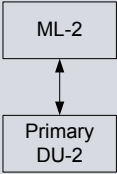
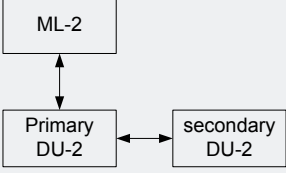
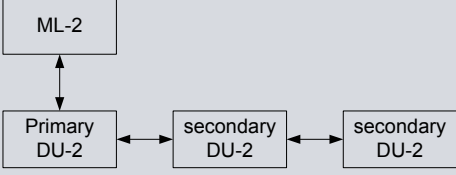
Set-up variants	Functionality of the primary DU-2	Functionality of the secondary DU-2	CAN bus ID of DU-2 connected to ML-2	CAN bus ID of secondary DU-2
	Read/write	-	0	-
	Read/write	Read	1	2
	Read/write	Read	1	2, 3



INFO

Pressing the "View" button for three seconds and entering the customer password on any secondary display will turn this DU-2 into the primary display and enable reading/writing from this display. There can only be one primary display in a set-up, so when turning a secondary display into primary, the former primary will automatically be switched to a secondary display.



INFO

For information on passwords, see the Designer's reference handbook.

4.3 Additional operator panel - AOP-1

4.3.1 Front side view

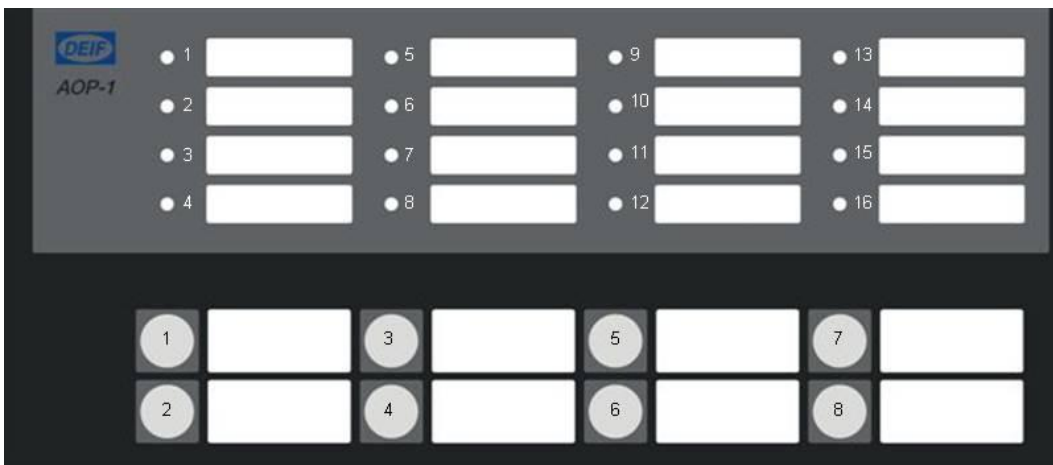

As shown on the drawing, the configurable LEDs are named 1 to 16, and the buttons are named 1 to 8.

4.3.2 Wiring

The AOP-1 is connected to the connection on the DU-2 named AOP-1 by means of the enclosed cable. This connection handles the communication and power supply.

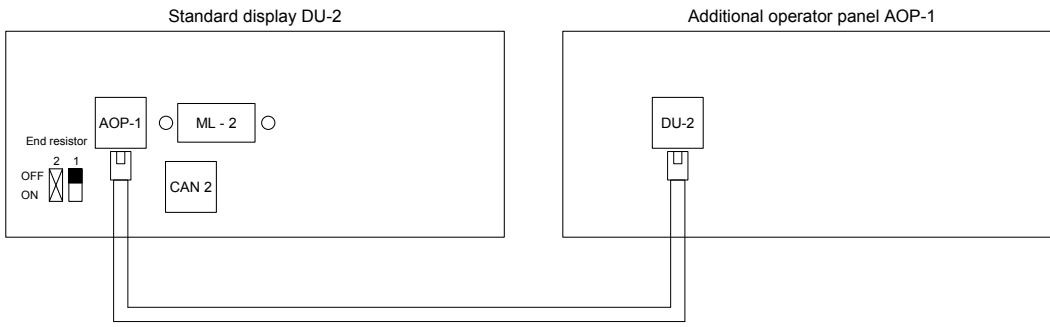

INFO
The maximum distance between the DU-2 and the AOP-1 is 0.5 m.



INFO
The cable for connection between the AOP-1 and DU-2 is included in the AOP-1 delivery.

4.3.3 CAN ID configuration

The ID of the AOP-1 is decided by the DU-2 unit to which it is connected.

4.3.4 Programming

The programming of the AOP-1 is made with the PC utility software, which can be downloaded from www.deif.com. See the Help function in the PC utility software for programming instructions.

4.4 Additional operator panel - AOP-2

4.4.1 Front side view

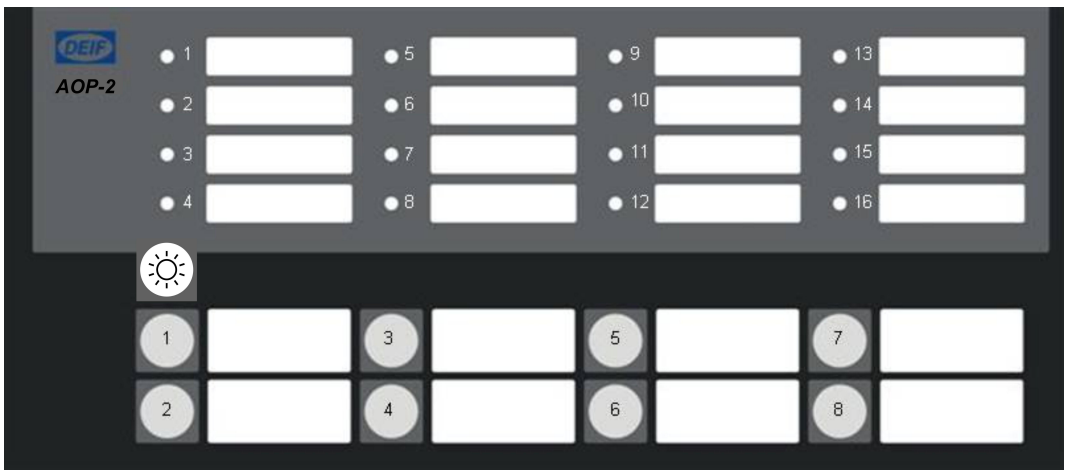

As shown on the drawing, the configurable LEDs are named 1 to 16, and the buttons are named 1 to 8.

4.4.2 Wiring - cable type 1



INFO
Be aware that two cables can be chosen, and that there is a difference in the colour codes of the wires. The diagrams below show how to wire up both cable types.

Standard display DU-2

Additional operator panel AOP-2

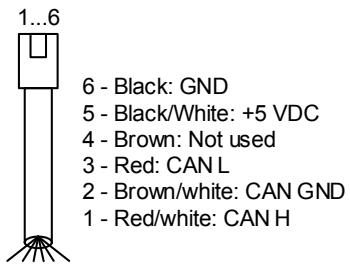
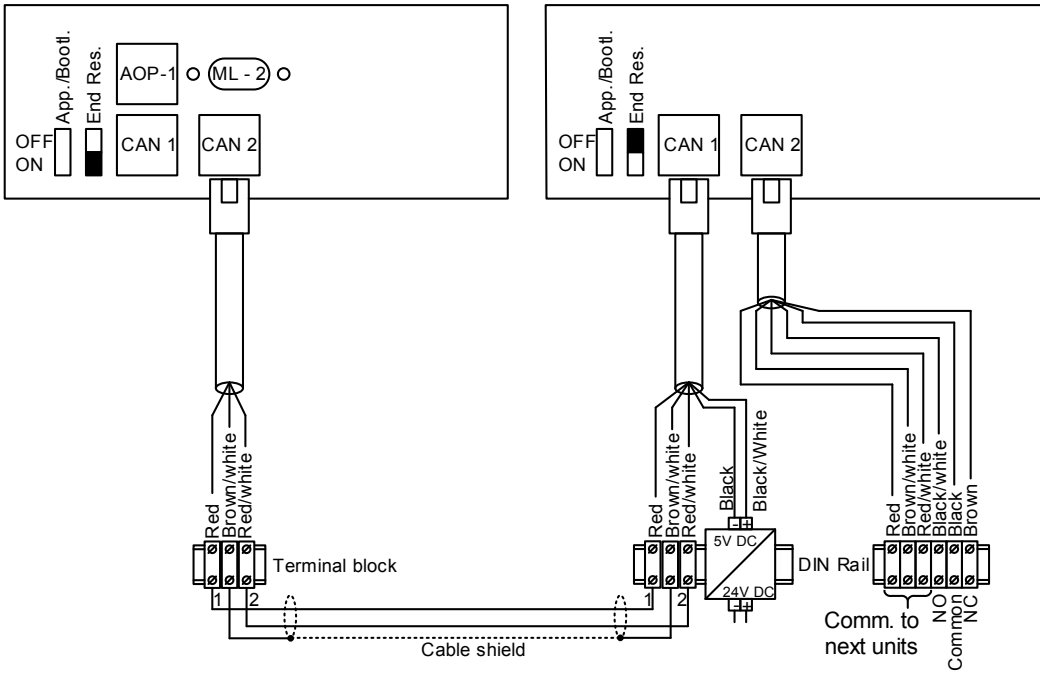

Left CANport (CAN 1)

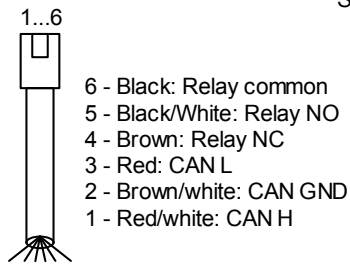

Right CANport (CAN 2)

Status relay

4.4.3 Wiring - cable type 2

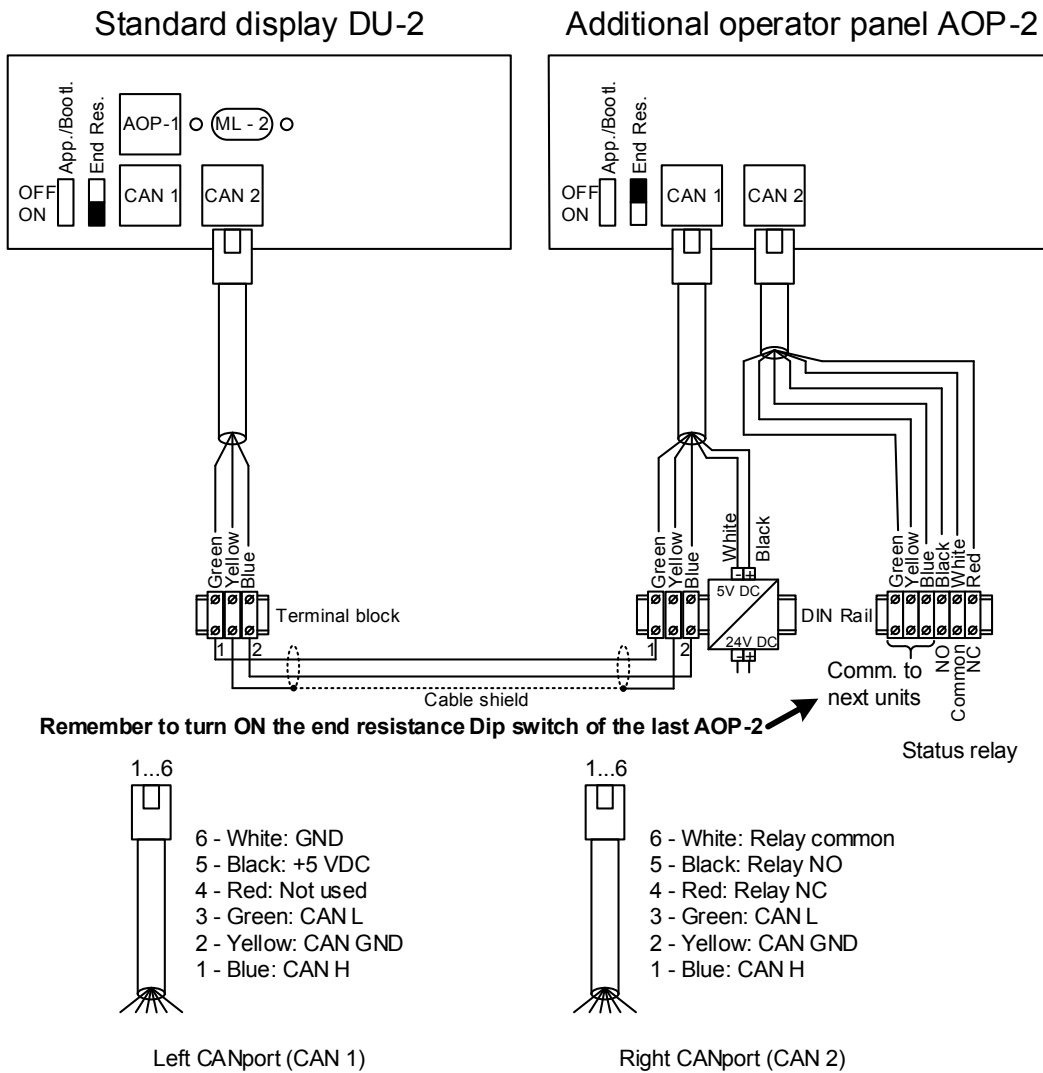

INFO

A DC/DC converter for the DC supply voltage and 2 x 1 m cable with an RJ12 plug in one end and stripped wires in the other end is included in the AOP-2 delivery.



INFO

The cable between the terminal blocks should be shielded twisted pair.



INFO

The maximum length of the CAN bus line is 200 m.

4.4.4 End resistor

- 2 units connected: Dip switch no. 1 on both units should be set to ON.
- 3 units connected: Dip switch no. 1 on unit 1 and unit 3 should be set to ON.
- More than 3 units connected: Dip switch no. 1 on the first and the last unit on the CAN bus line should be set to ON.

4.4.5 CAN ID configuration

The CAN ID for the AOP-2 can be changed by the following procedure:

1. Push button no. 7 and no. 8 at the same time to activate the CAN ID change menu, this will activate the LED for the present CAN ID number, and LED no. 16 will be flashing.
2. Use button no. 7 (increase) and button no. 8 (decrease) to change the CAN ID according to the table below.
3. Press button no. 6 to save the CAN ID and return to normal operation.

Selection of CAN ID:

CAN ID	Indication of CAN ID selection
0	CAN bus OFF: LED 16 flashes
1	LED 1 light steady + LED 16 flashes (default value)
2	LED 2 light steady + LED 16 flashes
3	LED 3 light steady + LED 16 flashes
4	LED 4 light steady + LED 16 flashes
5	LED 5 light steady + LED 16 flashes

4.4.6 Status relay

The status relay will activate approximately five seconds after power-up.

4.4.7 Programming

The programming of the AOP-2 is made with the PC utility software, which can be downloaded from www.deif.com. See the Help function in the PC utility software for instructions regarding the programming.

4.4.8 Lamp test/dimmer

The AOP-2 has a separate push-button for the combined lamp test and dimmer functionality.



A short activation of the push-button will activate the lamp test function. If no further action is done within three seconds, the AOP-2 will turn back to normal indication.

To activate the dimmer function, the push-button has to be pressed more times or continuously to reach the desired light intensity.

4.5 Error handling

4.5.1 Duplicate CAN ID

DU-2:

If two units on the CAN bus have the same CAN ID, the following will be displayed:

Warning: Two displays have same CAN ID Press Enter.

When ENTER is pressed, the CAN ID change menu will be displayed and another CAN ID can be selected for the unit.