

iE 350

Intelligent energy controller
Installation instructions



1. About the installation instructions

1.1 Symbols and notation.....	6
1.2 Previous document numbers.....	6
1.3 Intended users of the Installation instructions.....	7
1.4 Need more information?.....	7
1.5 Warnings and safety.....	7
1.6 Legal information.....	10

2. Prepare for installation

2.1 Mount options.....	11
2.2 CAD drawings.....	11
2.3 Location.....	13
2.3.1 Rack R4.1 or R7.1.....	13
2.3.2 iE 7 Display.....	14
2.4 Tools.....	15
2.4.1 Rack R4.1 or R7.1.....	15
2.4.2 iE 7 Display.....	16
2.5 Additional materials.....	17
2.6 Personal Protective Equipment (PPE).....	17
2.7 Safety and precautions.....	18

3. Mount the equipment

3.1 Before you begin the installation.....	19
3.2 Base mount controller or rack.....	20
3.2.1 R4.1.....	20
3.2.1.1 R4.1 Rack dimensions.....	20
3.2.1.2 R4.1 Mounting hole dimensions.....	21
3.2.2 R7.1.....	22
3.2.2.1 R7.1 Rack dimensions.....	22
3.2.2.2 R7.1 Mounting hole dimensions.....	23
3.2.3 Mount on flat surface.....	24
3.2.4 Rack cable strain relief.....	25
3.3 Display.....	26
3.3.1 iE 7 display.....	26
3.3.2 Panel cutout.....	27
3.3.3 Mount the unit.....	28
3.3.4 iE 7 Display cable strain relief.....	29
3.4 Hardware modules.....	30
3.4.1 Change supplied configuration.....	30
3.4.2 Rack slot requirements.....	31
3.4.3 Change hardware modules.....	32
3.4.3.1 No hot swapping modules.....	32
3.4.3.2 Remove hardware modules.....	33
3.4.3.3 Mount hardware modules.....	35

4. Wiring the equipment

4.1 About the wiring.....	37
4.1.1 Technical specifications.....	37
4.1.2 Encoding pins for terminals.....	37
4.1.3 Wire up from left to right.....	37
4.1.4 Default functions.....	37

- 4.1.5 Supervised binary inputs..... 37
- 4.2 Typical wiring..... 38**
- 4.2.1 About the typical wiring..... 38
- 4.2.2 iE 350..... 40
 - 4.2.2.1 SINGLE genset controller wiring..... 40
 - 4.2.2.2 GENSET controller wiring..... 42
 - 4.2.2.3 MAINS controller wiring..... 43
 - 4.2.2.4 BUS TIE breaker controller wiring..... 45
- 4.2.3 iE 350 Marine..... 46
 - 4.2.3.1 GENSET controller wiring..... 46
 - 4.2.3.2 EMERGENCY genset controller wiring..... 48
 - 4.2.3.3 HYBRID controller wiring..... 49
 - 4.2.3.4 SHAFT controller wiring..... 51
 - 4.2.3.5 SHORE connection controller wiring..... 53
 - 4.2.3.6 BUS TIE breaker controller wiring..... 55
- 4.3 Power supply module PSM3.1..... 57**
- 4.3.1 PSM3.1 terminal connections..... 57
- 4.3.2 Frame ground wiring..... 57
- 4.3.3 Power supply wiring..... 58
- 4.3.4 Relay output wiring..... 59
- 4.3.5 PSM3.x EtherCAT connections..... 60
- 4.3.6 Topology examples..... 61
- 4.4 Power supply module PSM3.2 (Extension rack)..... 62**
- 4.4.1 PSM3.2 terminal connections..... 62
- 4.4.2 Frame ground wiring..... 62
- 4.4.3 Power supply wiring..... 63
- 4.4.4 Relay output wiring..... 64
- 4.4.5 PSM3.x EtherCAT connections..... 65
- 4.4.6 Topology examples..... 67
- 4.5 Alternating current module ACM3.1..... 68**
- 4.5.1 ACM3.1 terminal connections..... 68
- 4.5.2 Voltage encoding pins for ACM3.1..... 69
- 4.5.3 Voltage measurements wiring..... 70
- 4.5.4 Current measurements wiring..... 70
- 4.5.5 Power transformer..... 71
- 4.6 Differential current module ACM3.2..... 71**
- 4.6.1 ACM3.2 terminal connections..... 71
- 4.6.2 Current encoding pins for ACM3.2..... 72
- 4.6.3 Current measurements wiring..... 72
- 4.7 Input/output module IOM3.1..... 74**
- 4.7.1 IOM3.1 terminal connections..... 74
- 4.7.2 Relay output wiring (changeover)..... 74
- 4.7.3 Digital input wiring..... 75
- 4.8 Input/output module IOM3.2..... 78**
- 4.8.1 IOM3.2 terminal connections..... 78
- 4.8.2 Relay output wiring..... 79
- 4.8.3 Pulse width modulation (PWM) output wiring (terminals 9-10 or 11-12 only)..... 80
- 4.8.4 Analogue multifunctional current or voltage outputs wiring..... 80
- 4.8.5 Digital input wiring..... 81
- 4.8.6 Analogue multifunctional inputs wiring..... 84

4.9 Input/output module IOM3.3	87
4.9.1 IOM3.3 terminal connections.....	87
4.9.2 Analogue multifunctional inputs.....	87
4.9.3 Digital inputs wiring with wire break detection.....	88
4.9.4 Analogue current inputs wiring.....	88
4.9.5 Analogue voltage inputs wiring.....	89
4.9.6 Analogue resistance inputs wiring.....	89
4.9.7 Analogue thermocouple inputs wiring.....	91
4.10 Input/output module IOM3.4	93
4.10.1 IOM3.4 terminal connections.....	93
4.10.2 Digital output wiring.....	94
4.10.3 Digital input wiring.....	94
4.11 Engine interface module EIM3.1	97
4.11.1 EIM3.1 terminal connections.....	97
4.11.2 Frame ground wiring.....	98
4.11.3 Power supply wiring.....	98
4.11.4 Relay output wiring.....	99
4.11.5 Relay output with wire break detection.....	99
4.11.6 Digital input wiring.....	101
4.11.7 Magnetic pickup unit (MPU) input wiring.....	104
4.11.8 W input wiring.....	104
4.11.9 Analogue current or resistance inputs wiring.....	105
4.12 Governor and AVR module GAM3.1	108
4.12.1 GAM3.1 terminal connections.....	108
4.12.2 Relay output wiring.....	108
4.12.3 Load sharing wiring.....	109
4.12.4 Analogue current or voltage outputs wiring.....	109
4.12.5 Pulse width modulation (PWM) output wiring.....	110
4.12.6 Analogue current or voltage input wiring.....	110
4.13 Governor and AVR module GAM3.2	112
4.13.1 GAM3.2 terminal connections.....	112
4.13.2 Frame ground wiring.....	113
4.13.3 Power supply wiring.....	113
4.13.4 Analogue current or voltage outputs wiring.....	114
4.13.5 Pulse width modulation (PWM) output wiring.....	115
4.13.6 Digital input wiring.....	115
4.13.7 Relay output wiring.....	118
4.14 Processor and communication module PCM3.3	119
4.14.1 PCM3.3 terminal connections.....	119
4.14.2 CAN bus ECU or DAVR communication.....	120
4.14.3 Serial communication COM 1 / COM 2.....	121
4.14.4 PCM3.3 Network connections.....	122
4.14.5 External third-party display.....	125
4.14.6 Topology restrictions.....	125
4.14.7 Topology examples.....	125
4.15 Example wiring for controller functions	127
4.15.1 System AC configuration.....	127
4.15.2 [A-side] or [B-side] AC configuration.....	132
4.15.3 Pulse breaker.....	133
4.15.4 Continuous breaker.....	133

4.15.5 Compact breaker.....	134
4.15.6 External breaker.....	134
4.15.7 Redundant breaker feedback.....	135
4.15.8 Regulation : Current output for voltage regulation.....	135
4.15.9 Power management : Heavy consumer wiring.....	136
4.16 Display.....	138
4.16.1 iE 7 display Power supply.....	138
4.16.2 iE 7 display connections.....	139
5. Maintenance	
5.1 Precautions before maintenance.....	140
5.2 Personnel and equipment protection.....	140
5.3 Rack slot requirements.....	142
5.4 Change hardware modules.....	143
5.4.1 No hot swapping modules.....	143
5.4.2 Remove hardware modules.....	144
5.4.3 Mount hardware modules.....	146
5.5 Replace RTC battery.....	148
5.5.1 Location of RTC battery on PCM3.3 module.....	148
5.5.2 How to replace the RTC battery.....	149
6. iE 350 as a marine safety system	
6.1 Fast over-current protection (ANSI 50/50TD).....	152
6.1.1 About the safety system for ANSI 50/50TD.....	152
6.1.2 Current transformer requirements.....	152
6.1.3 Power supply requirements.....	152
6.1.4 Function requirements.....	152
6.1.5 Parameter requirements.....	152
7. End-of-life	
7.1 Disposal of waste electrical and electronic equipment.....	154

1. About the installation instructions

1.1 Symbols and notation

Symbols for general notes

NOTE This shows general information.



More information

This shows where you can find more information.



Example

This shows an example.



How to ...

This shows a link to a video for help and guidance.

Symbols for hazard statements



DANGER!



This shows dangerous situations.

If the guidelines are not followed, these situations will result in death, serious personal injury, and equipment damage or destruction.



WARNING



This shows potentially dangerous situations.

If the guidelines are not followed, these situations could result in death, serious personal injury, and equipment damage or destruction.



CAUTION



This shows low level risk situation.

If the guidelines are not followed, these situations could result in minor or moderate injury.

NOTICE



This shows an important notice

Make sure to read this information.

1.2 Previous document numbers

This document replaces the following document numbers:

- iE 350 Installation instructions 4189341378 - Revision A

- iE 350 Marine Installation instructions 4189341379 - Revision F
- iE 350 Marine Power management Installation instructions 4189341393 - Revision F

1.3 Intended users of the Installation instructions

The Installation instructions are primarily intended for the installer who mounts and wires up the controllers and displays. The Installation instructions can also be used for commissioning to check the installation.

1.4 Need more information?

Get direct access to the resources that you need by using the links below.



Official DEIF homepage.

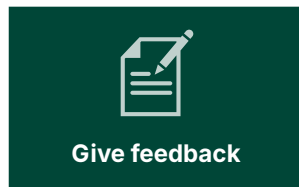

Help improve our documentation with your feedback.

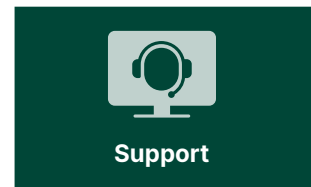

Self-help resources and how to contact DEIF for assistance.

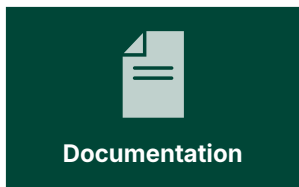

iE 350 documentation.

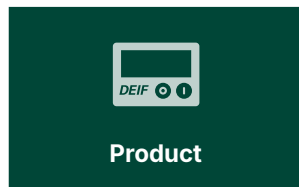

iE 350 product page.

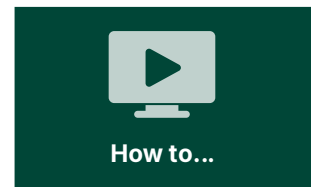

Learn how to use this product.

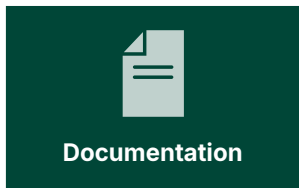

iE 350 Marine documentation.



iE 350 Marine product page.

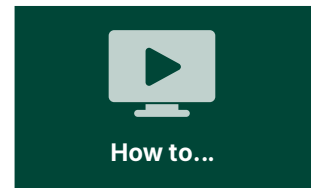

Learn how to use this product.

1.5 Warnings and safety

Safety during installation and operation

When you install and operate the equipment, you may have to work with dangerous currents and voltages. The installation must only be carried out by authorised personnel who understand the risks involved in working with electrical equipment.

DANGER!

Hazardous live currents and voltages

Do not touch any terminals, especially the AC measurement inputs or any relay terminals, as this could lead to injury or death.

Disable the breakers



DANGER!

Disable the breakers



Unintended breaker closing can cause deadly and/or dangerous situations.

Disconnect or disable the breakers **BEFORE** you connect the controller power supply. Do not enable the breakers until **AFTER** the wiring and controller operation are thoroughly tested.

Disable the engine start



DANGER!

Unintended engine starts



Unintended engine starts can cause deadly and/or dangerous situations.

Disconnect, disable or block the engine start (the crank and the run coil) **BEFORE** you connect the controller power supply. Do not enable the engine start until **AFTER** the wiring and controller operation are thoroughly tested.

Metal fragments and other objects

Keep metal fragments and other objects out of the controller or display, as these can damage the equipment. Be especially careful when you install the equipment.

To prevent metal fragments from getting into the controller or extension rack, we recommend to place the supplied cover over the top ventilation holes when you install the rack. Remember to remove the cover after you finish the work. Failure to do so can damage the controller or extension rack.

Electrostatic discharge



ATTENTION

Observe precautions for handling

Electrostatic sensitive devices

Protect the equipment terminals from electrostatic discharge when not installed in a grounded rack.

Electrostatic discharge could damage the equipment.

Controller power supply

It is recommended that the controller has both a reliable power supply and a backup power supply. The switchboard design must ensure sufficient protection of the system, if the controller power supply fails.

Connect the controller (or extension rack) protective earth



DANGER!

Failure to ground



Failure to ground the controller (or extension rack) could lead to injury or death.

You must ground the controller (or extension rack) to a protective earth.

Switchboard control (Marine)

In *Switchboard control*, the operator operates the equipment from the switchboard. When *Switchboard control* is activated:

- The controller trips the breaker and/or shuts down the engine, if an alarm situation arises that requires a trip and/or shutdown.
- The controller **does not** respond to a blackout.
- The controller **does not** provide power management.
- The controller **does not** accept operator commands.
- The controller cannot and **does not** prevent manual operator actions.

The switchboard design must protect the system when the controller is in *Switchboard control*.



DANGER!

Manual override of alarm action



Do not use switchboard or manual control to override the alarm action of an active alarm.

An alarm may be active because it is latched, or because the alarm condition is still active. If the alarm action is manually overridden, the latched alarm provides no protection.

Factory settings

The controller is delivered pre-programmed from the factory with a set of default settings. These settings are based on typical values and may not be correct for your system. You must therefore check all parameters before using the controller.

Automatic and remote-controlled starts



CAUTION

Automatic genset start



The power management system automatically starts gensets when more power is needed. It can be difficult for an inexperienced operator to predict which gensets will start. In addition, gensets can be started remotely (for example, via an Ethernet connection, or a digital input).

To avoid personal injury, the genset design, the layout, and maintenance procedures must take this into account.

Data security

While DEIF has taken great attention to data security and has designed the product to be a secure product, we recommend adopting Information Technology (IT) and Operational Technology (OT) security best practices when connecting the controller to a network.

To minimise the risk of data security breaches we recommend:

- Only connect to trusted networks and avoid public networks and the Internet.
- Use additional security layers like a VPN for remote access.
- Restrict access to authorised persons.

Do not use unsupported hardware modules

Only use the hardware modules that are listed in the Technical specifications.

1.6 Legal information

Third party equipment

DEIF takes no responsibility for installation or operation of any third party equipment. In no event shall DEIF be liable for any loss of profits, revenues, indirect, special, incidental, consequential, or other similar damages arising out of or in connection with any incorrect installation or operation of any third party equipment.

Warranty

NOTICE

Warranty



The warranty will be lost if the warranty seals are broken. The rack may only be opened to remove, replace, and/or add a hardware module or the internal RTC battery (if fitted). The procedure in the *Installation instructions* must be followed. If the rack is opened for any other reason, and/or the procedure is not followed, then the warranty is void.

If the display is opened, then the warranty is void.

Trademarks

DEIF and the DEIF logo are trademarks of DEIF A/S.

Bonjour[®] is a registered trademark of Apple Inc. in the United States and other countries.

Adobe[®], *Acrobat*[®], and *Reader*[®] are either registered trademarks or trademarks of Adobe Systems Incorporated in the United States and/or other countries.

CANopen[®] is a registered community trademark of CAN in Automation e.V. (CiA).

SAE J1939[®] is a registered trademark of SAE International[®].

CODESYS[®] is a trademark of CODESYS GmbH.

EtherCAT[®], *EtherCAT P*[®], *Safety over EtherCAT*[®], are trademarks or registered trademarks, licensed by Beckhoff Automation GmbH, Germany.

VESA[®] and *DisplayPort*[®] are registered trademarks of Video Electronics Standards Association (VESA[®]) in the United States and other countries.

Google[®] and *Google Chrome*[®] are registered trademarks of Google LLC.

Linux[®] is a registered trademark of Linus Torvalds in the U.S. and other countries.

Modbus[®] is a registered trademark of Schneider Automation Inc.

Torx[®], *Torx Plus*[®] are trademarks or registered trademarks of Acument Intellectual Properties, LLC in the United States or other countries.

Windows[®] is a registered trademark of Microsoft Corporation in the United States and other countries.

All trademarks are the properties of their respective owners.

Disclaimer

DEIF A/S reserves the right to change any of the contents of this document without prior notice.

The English version of this document always contains the most recent and up-to-date information about the product. DEIF does not take responsibility for the accuracy of translations, and translations might not be updated at the same time as the English document. If there is a discrepancy, the English version prevails.

Copyright

© Copyright DEIF A/S. All rights reserved.

2. Prepare for installation

2.1 Mount options

The iE 350 is highly flexible for different mounting locations.



NOTE Contact DEIF for availability of some versions.

2.2 CAD drawings

CAD / DWG Drawings



www.deif.com/rtd/ie350/cad

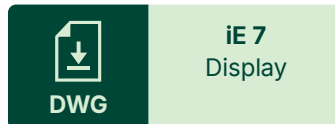

www.deif.com/rtd/ie7/dwg

STP STEP-file



www.deif.com/rtd/ie350/stp



www.deif.com/rtd/ie7/stp

2D PDF



www.deif.com/rtd/ie350/2dpdf



www.deif.com/rtd/ie7/2dpdf

3D PDF

To view a 3D PDF you must enable multimedia and 3D content in your PDF viewer.



www.deif.com/rtd/ie350/3dpdf



www.deif.com/rtd/ie7/3dpdf

2.3 Location

2.3.1 Rack R4.1 or R7.1



The rack is designed to be mounted in an enclosure.

For UL/cUL listing, it must be:

- Mounted on a flat surface of a type 1 enclosure.
- Installed in accordance with the NEC (US) or the CEC (Canada).

The equipment must be installed and operated in a clean and dry environment, as specified in the **Data sheet**.

If the equipment is installed in an area subject to constant high vibrations, the equipment must be isolated from the vibrations. The installation environment must comply with the electrical, mechanical and environmental specifications of the equipment as described in the **Data sheet**.

Protect the controller terminals from static discharge during installation, especially while the frame ground is not connected. The rack must be grounded.

Ventilation requirements and spacing

Dust accumulation may damage the unit or lead to overheating. We recommend mounting the unit in a cabinet with a filter on the air supply.

For proper ventilation, the unit must be mounted with its back vertical, and its long axis horizontal. The writing on the unit must be horizontal.

NOTE The cable routing must not block the ventilation holes.

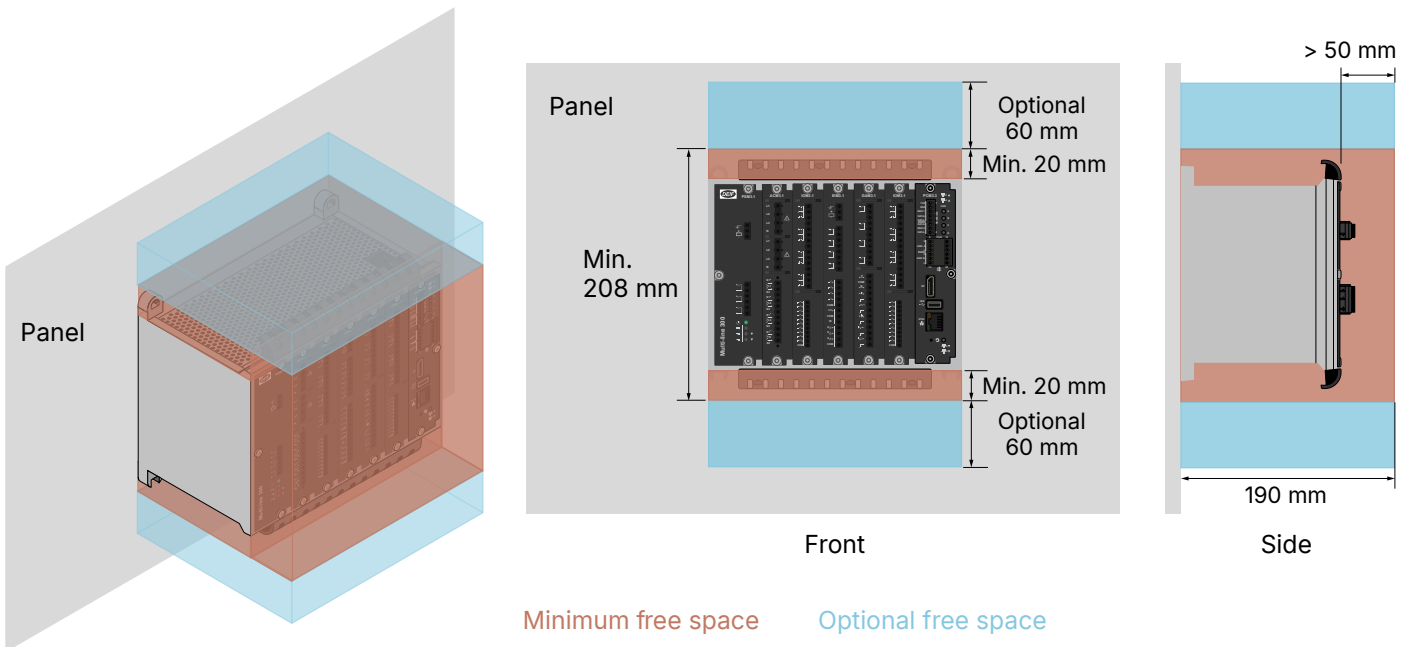

Inside the cabinet, there must be a minimum of 20 mm (0.8 in) free space above, below of the unit. Some cables, for example Ethernet cables, may require a minimum cable bend radius. We recommend that you always follow the cable manufacturer's bend radius requirements.

2.3.2 iE 7 Display

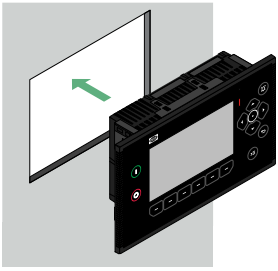

The display is designed to be mounted in a panel, with its back in an enclosure.

For UL/cUL listing, it must be:

- Mounted on a flat surface of a type 1 enclosure.
- Installed in accordance with the NEC (US) or the CEC (Canada).

The display must be installed and operated in a clean and dry environment, as specified in the Data sheet.

If the equipment is installed in an area subject to constant high vibrations, the equipment must be isolated from the vibrations. The installation environment must comply with the electrical, mechanical and environmental specifications of the equipment as described in the Data sheet.

Ventilation requirements and spacing

The back of the display is not protected against dust. Dust accumulation may damage the unit or lead to overheating. We recommend mounting the unit in a cabinet with a filter on the air supply.

For proper ventilation, the unit must be mounted with its back vertical, and its long axis horizontal. The writing on the unit must be horizontal.

NOTE The display brightness may be affected if there is not enough ventilation.
The cable routing must not block the ventilation holes.

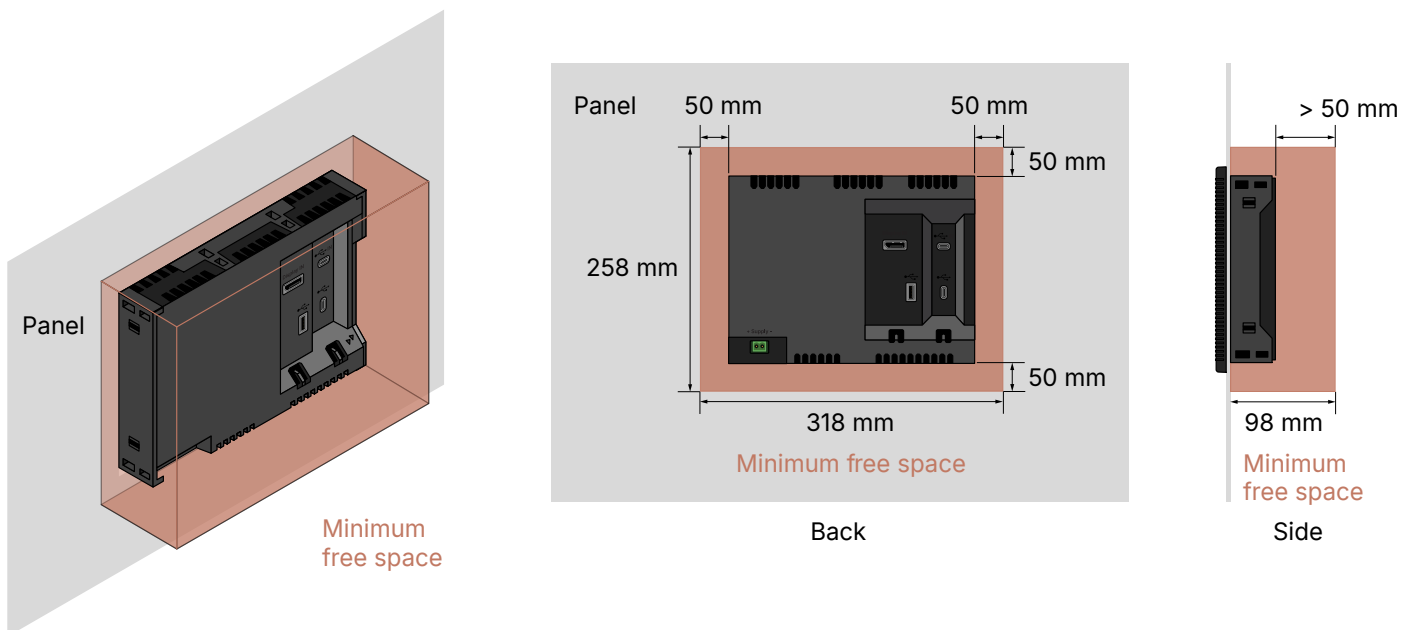

Inside the cabinet, there must be a minimum of 50 mm (2 in) free space above, below and at both sides of the unit. We recommend more than 50 mm (2 in) free space behind the unit for the cables and routing. Ethernet cables may require a minimum cable bend radius.

Total space requirement including minimum free space:

Height: 258 mm **Width:** 318 mm **Depth:** 137 mm

2.4 Tools

2.4.1 Rack R4.1 or R7.1

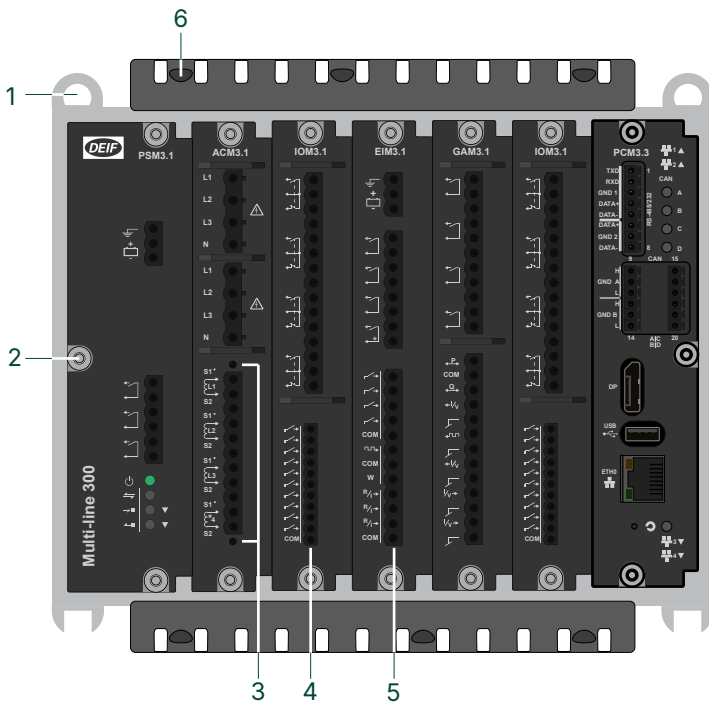

#	Tool	Attachment	Torque	Used to
-	Screwdriver	PH2 bit or a 5 mm (0.2 in) flat-bladed bit	0.15 N·m (1.3 lb-in)	Tighten the display fixing screw clamps.
1.	Wrench *	10 mm hex socket for 6 mm nuts (7/16 in hex socket for 1/4 in nuts)	Enough torque to tighten to wall.	Tighten the nuts on the mounting bolts.
2.	Screwdriver	TX20 bit	0.5 N·m (4.4 lb-in)	Remove or add modules in the rack.
3.	Screwdriver.	3.5 mm (0.14 in) flat-bladed bit	0.25 N·m (2.2 lb-in)	Remove and secure the current measurement terminal block to the AC module faceplate.
4.	Screwdriver	2.5 mm (0.1 in) flat-bladed bit	0.25 N·m (2.2 lb-in)	Connect the wiring to the 1.5 mm ² terminals.
5.	Screwdriver	3.5 mm (0.14 in) flat-bladed bit	0.5 N·m (4.4 lb-in)	Connect the wiring to the 2.5 mm ² terminals.
6.	Screwdriver	TX10 bit	0.5 N·m (4.4 lb-in)	Remove or remount the cable strain relief plates.

NOTE * The size of the torque wrench attachment depends on the nut and bolt size of the mounting bolts. These parts are not supplied by DEIF and the sizes mentioned are only a recommendation.

NOTICE



Torque damage to equipment

Do not use power tools during the installation. Too much torque damages the equipment.

Follow the instructions for the correct amount of torque to apply.

2.4.2 iE 7 Display

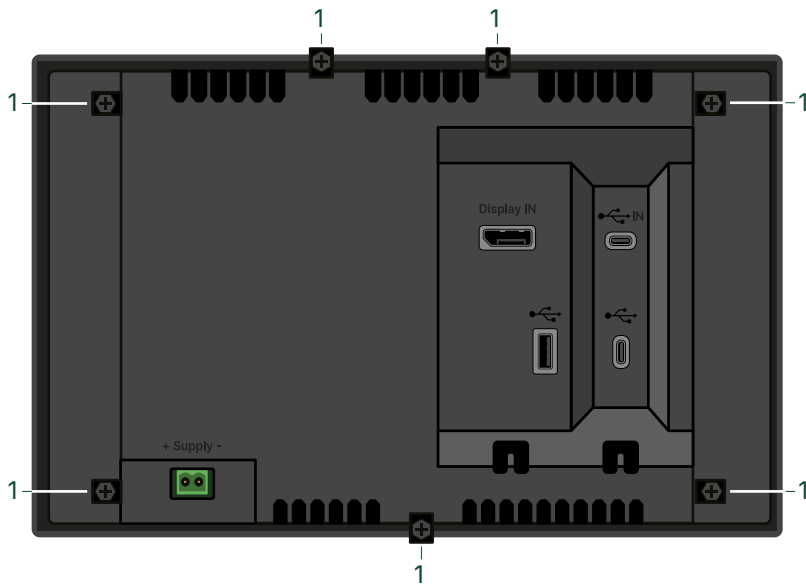

No.	Tool	Attachment	Torque	Used to
1.	Screwdriver	PH2 bit or a 5 mm (0.2 in) flat-bladed bit	0.1 N·m (0.9 lb-in)	Tighten the display unit fixing screw clamps.
-	Screwdriver	3 mm (0.12 in) flat-bladed bit	0.5 N·m (4.4 lb-in)	Connect the wiring to the 2.5 mm ² terminals.

NOTICE







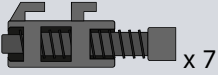

Torque damage to equipment

Do not use power tools during the installation. Too much torque damages the equipment.

Follow the instructions for the correct amount of torque to apply.

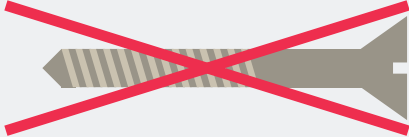
2.5 Additional materials

Material / Item	Version	Notes
Safety equipment	-	Personal protection according to local standards and requirements.
Conducting wrist strap	-	Prevent damage from electrostatic discharge.
Seven screw clamps	Display	To mount the display in the front panel.  x 7 Supplied with product.
Four bolts or screws	Controller or extension racks.	To mount the controller rack on a flat surface. Screws  Bolts  Not supplied with product.  Do not use countersunk screws or bolts. 
Cable ties	Controller or extension racks.	R4.1 or R7.1 Max 2.5 mm  iE 7 Display Max 4.5 mm 
Wires and connectors	ALL	Wiring measuring points, DEIF equipment or any third party equipment to the controller terminals. Terminal blocks for the controller are supplied with product.
Ethernet cables	ALL	Connecting the controller communication between controllers, extension racks, and/or external systems.
USB cable	Controller rack	Connecting the controller to the display control.
DisplayPort cable	Controller rack	Connecting the controller to the display screen.
CAN cables	ALL	Connecting an ECU, DAVR, and/or external systems.
RS-282 or RS-485 cables	ALL	Connecting the controller via the communication ports COM 1 or COM 2. Only COM 1 supports RS-282.

2.6 Personal Protective Equipment (PPE)

Follow all local requirements and regulations for wearing PPE while you install or wire the product.

Example PPE but not limited to:



Ear protection



Eye protection



Wear gloves



Protective clothing

2.7 Safety and precautions

When you install and wire the equipment, you may have to work with or near dangerous currents and voltages. The installation must only be carried out by authorised personnel who understand the risks involved in working with electrical equipment.

Example safety precautions but not limited to:



Isolate power supply.



Ground the equipment.



Protect against static discharge.



Do not alter state during installation.



More information

See [Warnings and safety](#) for full details of all precautions to take during installation.

3. Mount the equipment

3.1 Before you begin the installation

The controller comes with the required hardware modules installed for the controller type. Additional modules can be added or removed on site.

If you replace a hardware module with a different type, the controller loses its maritime classification societies approvals. Replacing with a module of the same type will not affect maritime classification societies approvals.

The controller or extension rack is mounted in an enclosure. The display is mounted in a panel.

Changing the delivered configuration

You can mount the hardware modules in a different order from that recommended in these instructions. If you choose to do so, we recommend that you document the changes and include this information in the system documentation:

- Module name
- Module's rack slot number in the default configuration
- Module's rack slot number in your customised configuration

CAD drawings for both the controller, extension rack, and display can be downloaded from www.deif.com



More information

See [CAD drawings](#) for details and links to all the CAD files.

3.2 Base mount controller or rack

3.2.1 R4.1

3.2.1.1 R4.1 Rack dimensions

The racks are supplied with the cable strain relief plates mounted.

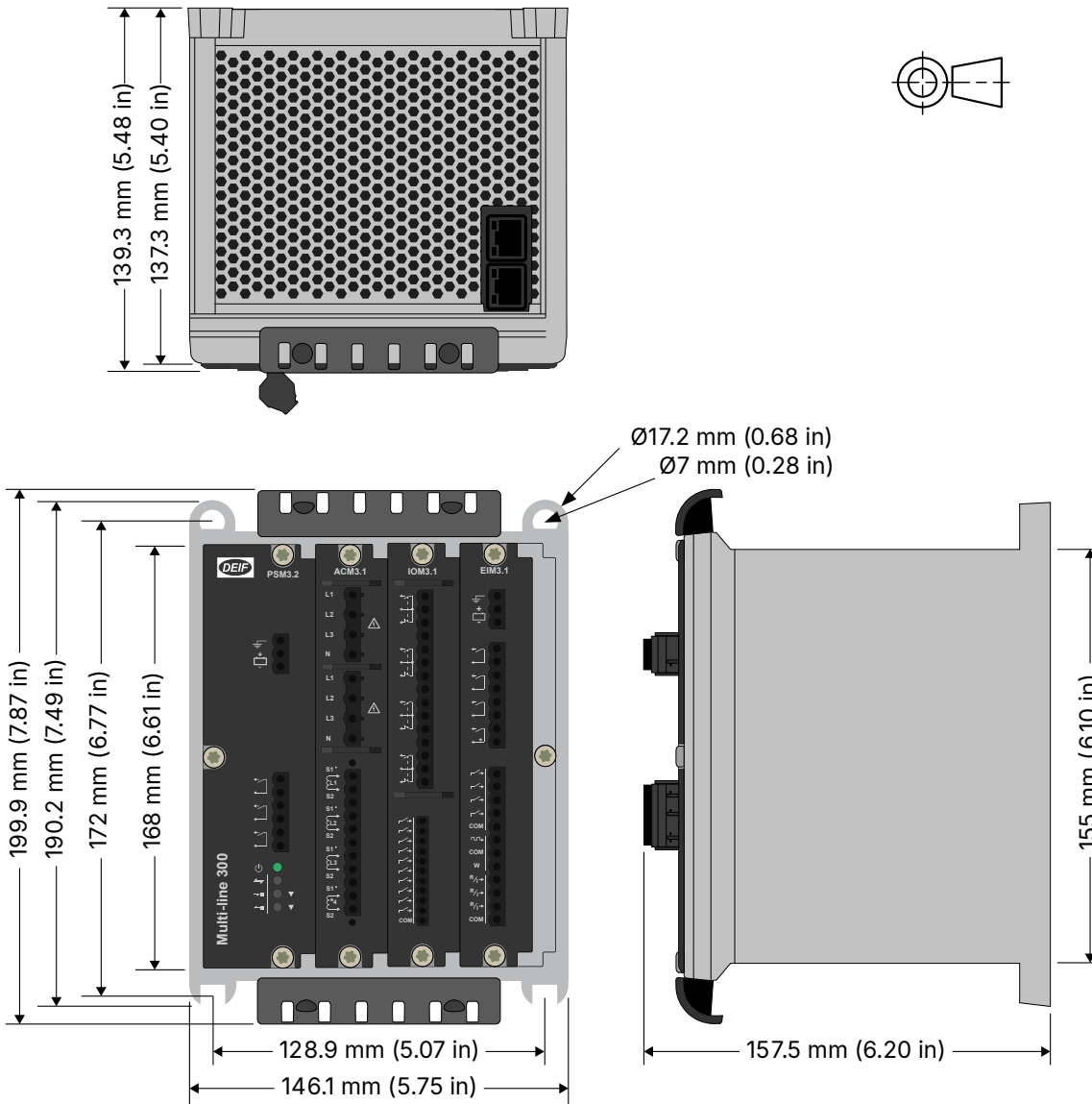

3.2.1.2 R4.1 Mounting hole dimensions

This dimension drawing is a guideline and not scale 1:1. The dimensions will not be correct when printed. Use the dimensions given to create your template.

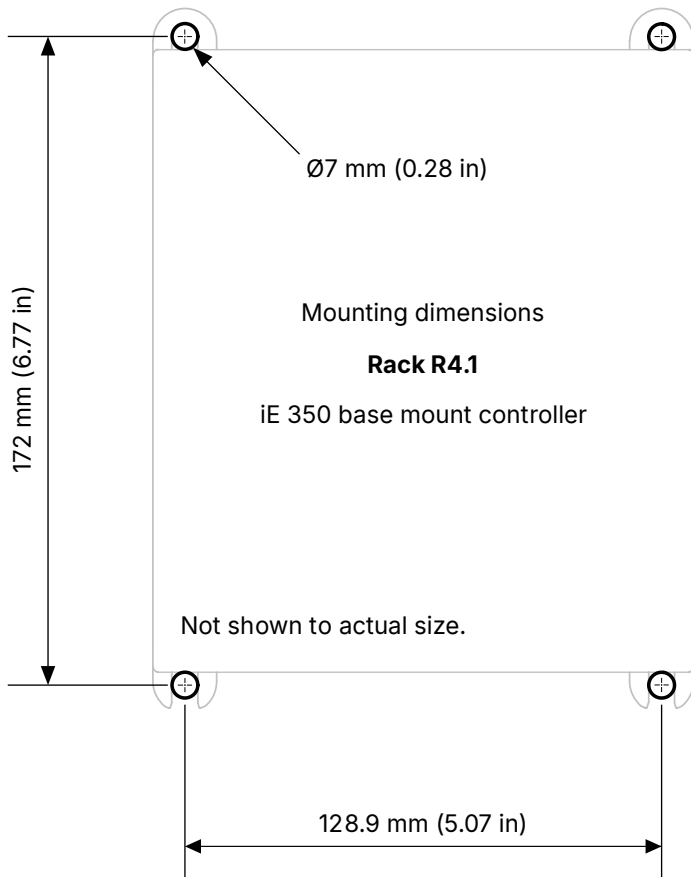

3.2.2 R7.1

3.2.2.1 R7.1 Rack dimensions

The racks are supplied with the cable strain relief plates mounted.

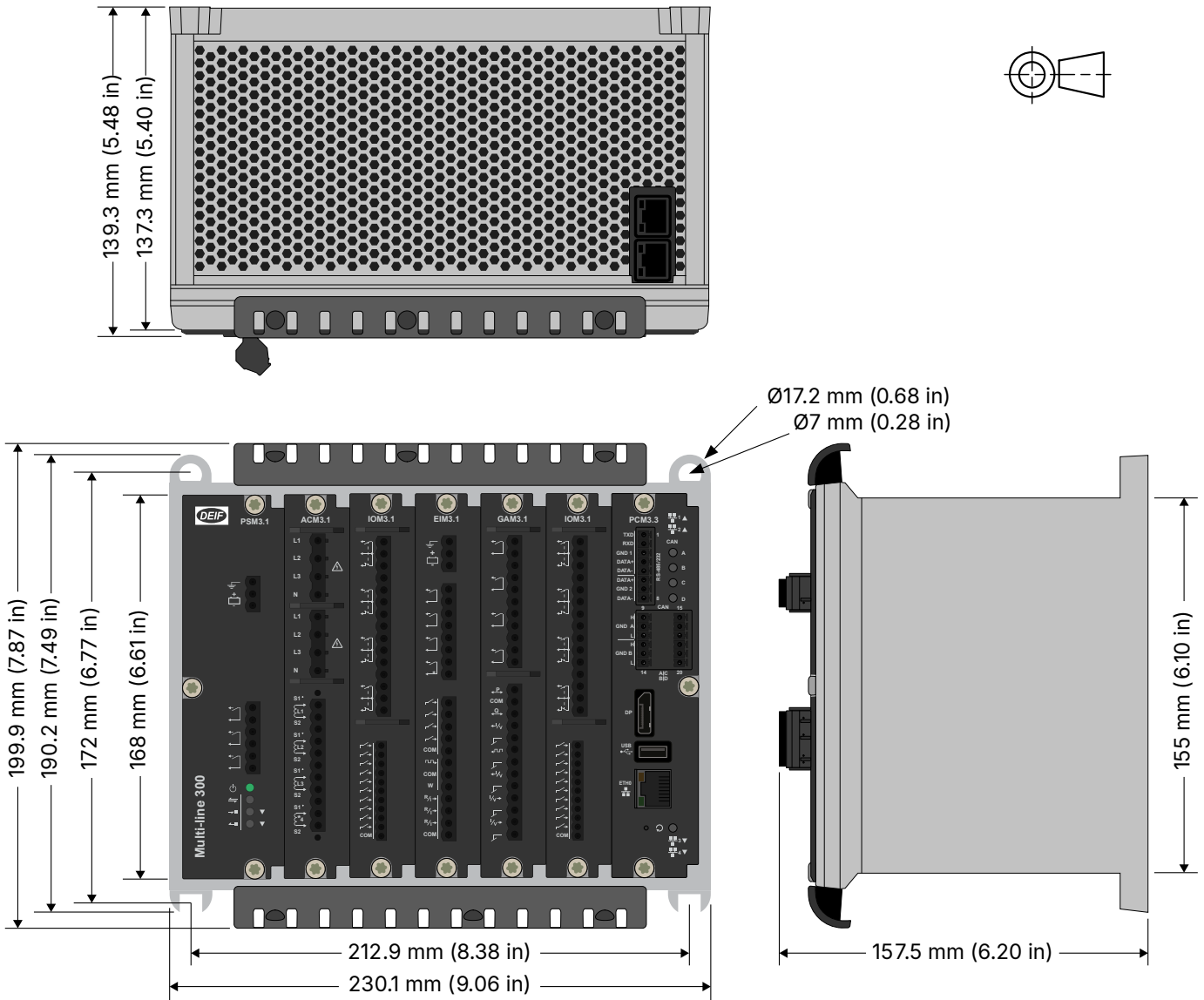

3.2.2.2 R7.1 Mounting hole dimensions

This dimension drawing is a guideline and not scale 1:1. The dimensions will not be correct when printed. Use the dimensions given to create your template.

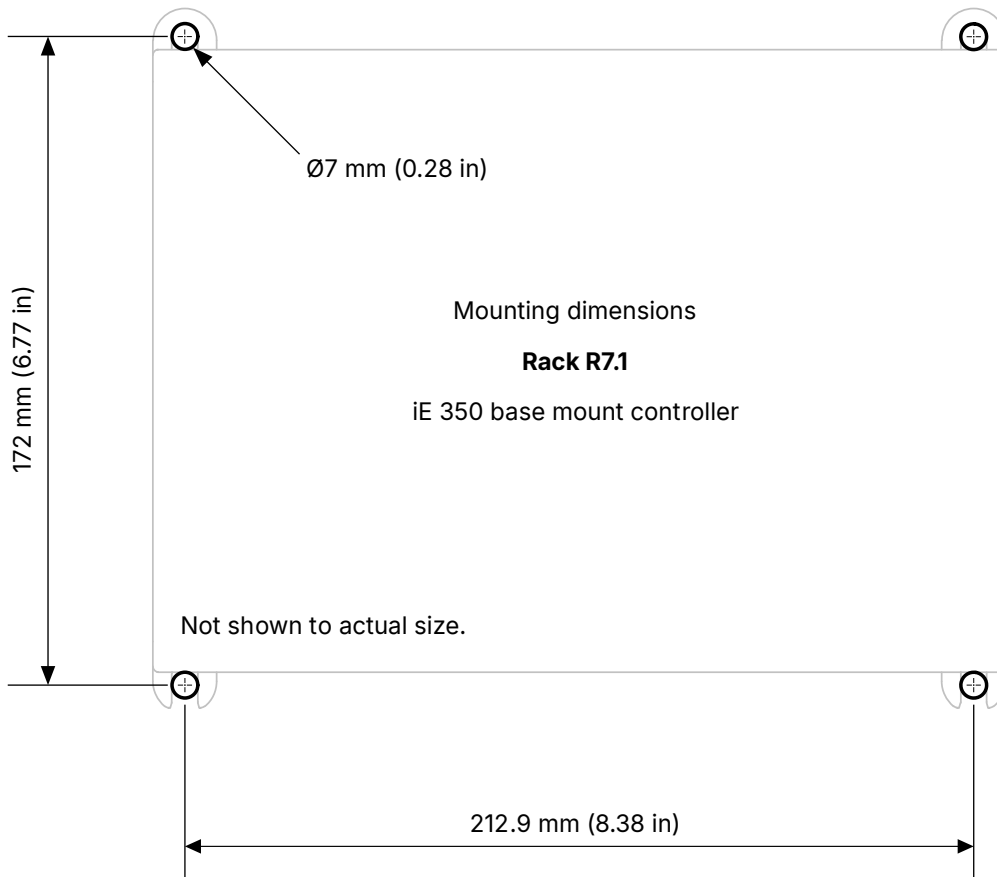

3.2.3 Mount on flat surface

Fasteners for mounting the rack

Fasteners for mounting are **not** supplied with the controller. The base mount fasteners must be able to support the weight of the rack and the wiring. See [Materials](#) for required bolt or screw sizes.

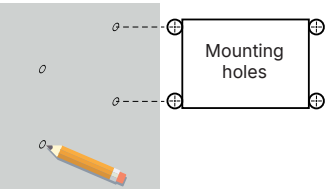
- 

1. Measure and mark the mounting holes on the surface.

 - For rack size R7.1 see [R7.1 Mounting hole dimensions](#).
 - For rack size R4.1 see [R4.1 Mounting hole dimensions](#).

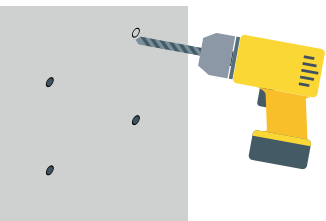
- 

2. Drill and tap the holes for mounting the rack.

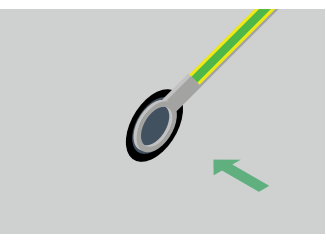
- 

3. Make sure to ground the controller or extension rack to a protective earth connection.

Use a grounding hoop with a toothed washer.

Galvanically connect the other end of the grounding wire to the grounding position of the enclosure.

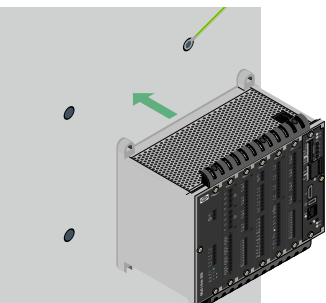
- 

4. Align the base mount unit to the holes, including washers as needed.

Remember to include the grounding washer.

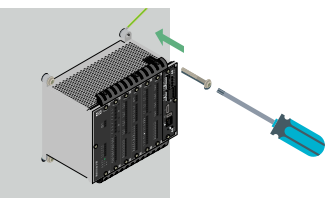
- 

5. Tighten all the fasteners until the unit is attached to the surface.

Do not overtighten the fasteners and damage the frame.

Do not exceed the recommended torque of 5 N·m (44 lb-in).



Failure to ground

Failure to ground the controller (or extension rack) could lead to injury or death.

You must ground the controller (or extension rack) to a protective earth.

3.2.4 Rack cable strain relief

Racks R4.1 and R7.1 have cable strain relief plates mounted at the top and the bottom. Use these to secure cables with cable ties.

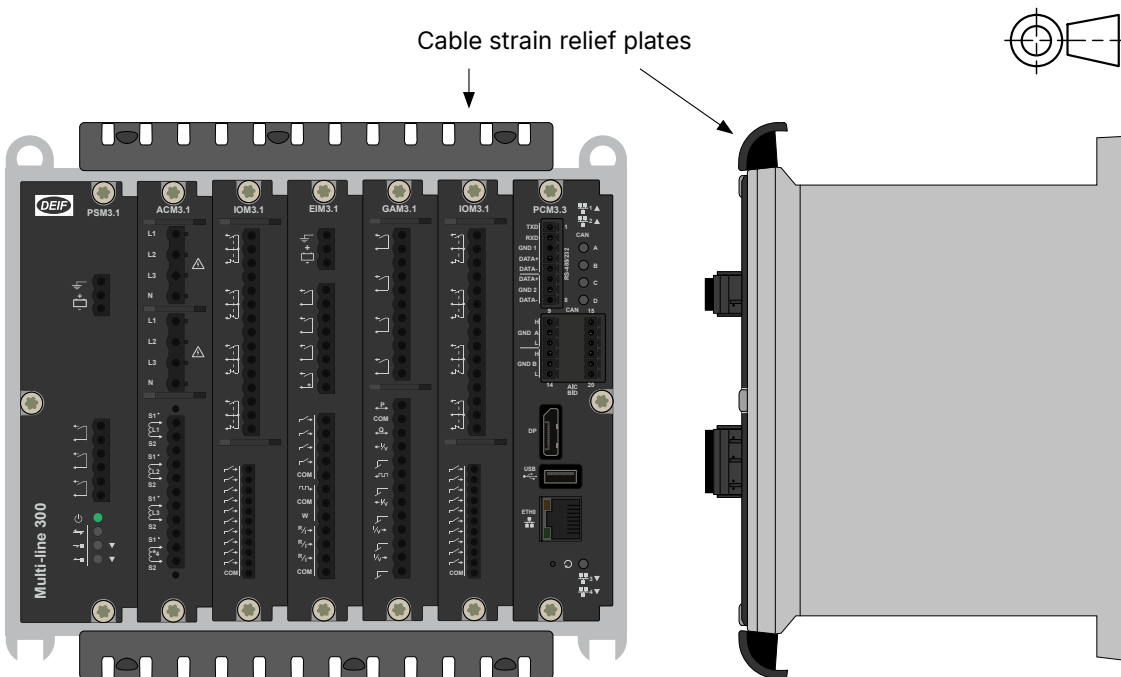

If needed, you can remove the plates by unscrewing the three 3 mm screws with a T10 screwdriver. When you remount a plate, tighten the screws with no more than 0.5 Nm (4.4 lb-in) of torque.

Cable tie slots

Rack R4.1 and R7.1 have cable tie slots inside the rack's aluminium frame. Rack R7.1 has six cable tie slots at the top, and six slots at the bottom. Rack R4.1 has four cable tie slots at the top, and six slots at the bottom.

The maximum cable tie width is 2.5 mm (0.1 in). The cable routing must not block more than 20 % of the ventilation holes.

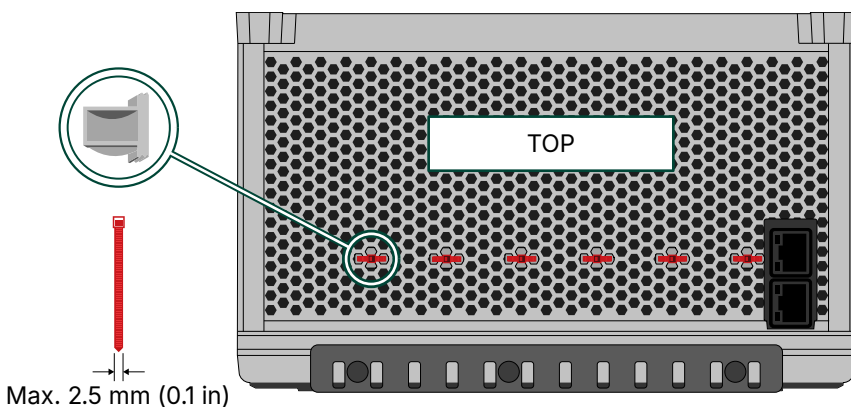

NOTICE

Maritime installations



The cable tie slots are inside the rack's aluminium frame.

Only use them if the maritime classification societies' rules allow the wiring to be secured directly to metal. Alternatively, you can use extra insulation between the rack's frame and the wire.

3.3 Display

3.3.1 iE 7 display

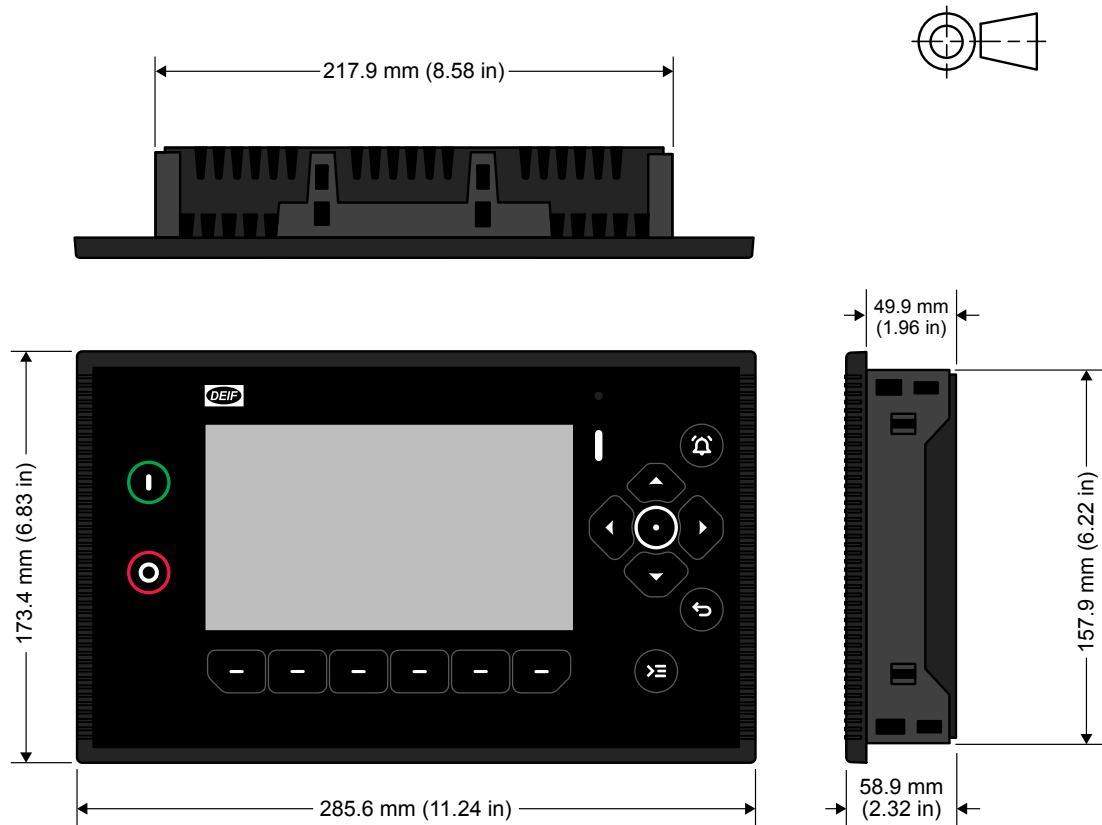

Category	Specifications
Dimensions	L×H×D: 285.6 × 173.4 × 58.9 mm (11.24 × 6.83 × 2.32 in) (outer frame)
Panel cutout	L×H: 220 × 160 mm (8.67 × 6.30 in)
Weight	840 g (1.9 lb)

Category	Specifications
Display	7", Projected Capacitive (PCAP), Touch
Resolution	1024x600 pixels (px)
Brightness	1200 Cd/m ²
Processor	1.6 GHz quad-core industrial grade ARMv8 64 bit CPU with ECC protected cache

3.3.2 Panel cutout

This panel cutout drawing is a guideline and not scale 1:1. The dimensions will not be correct when printed. Use the dimensions given to create your panel cutout template.

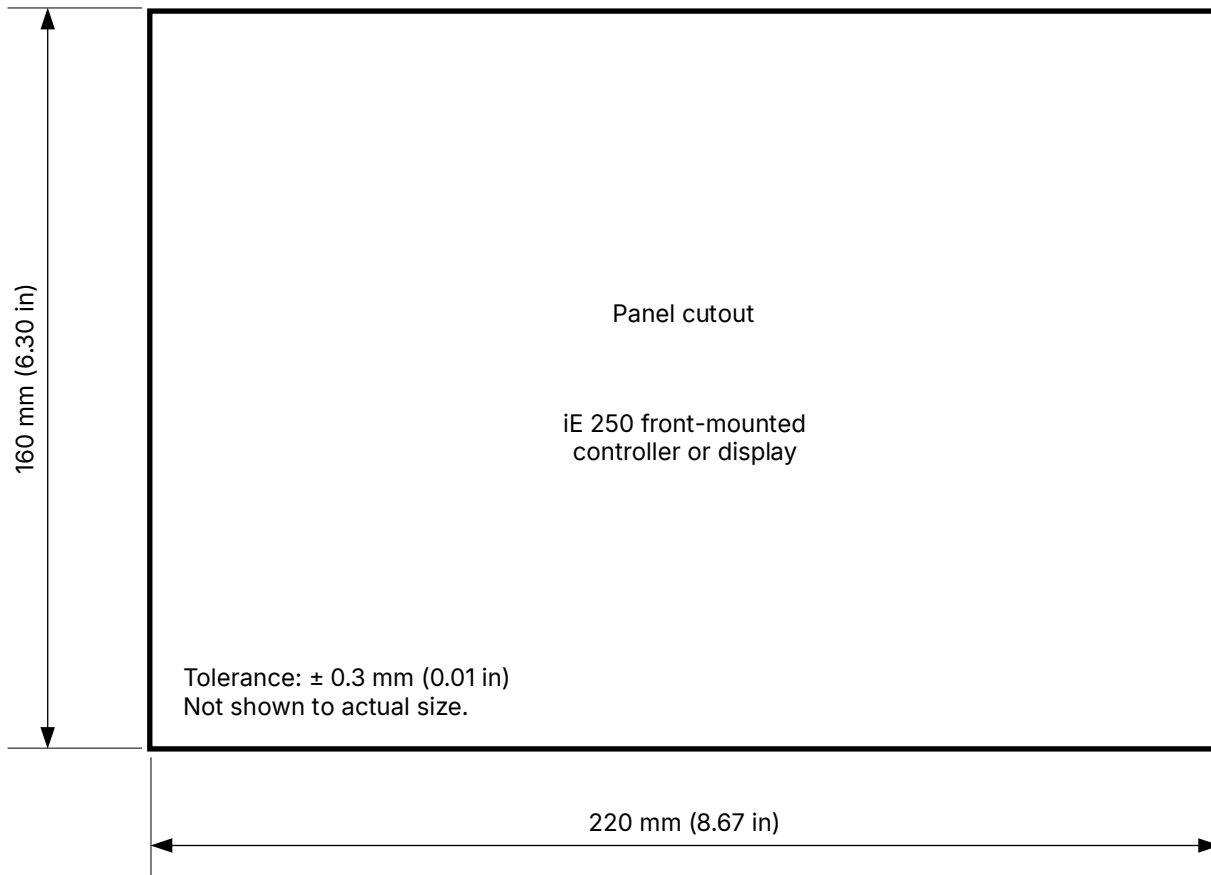

Panel thickness must be less than 10 mm (0.39 in).

3.3.3 Mount the unit

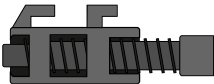
 x 7 The unit is mounted with seven fixing screw clamps (supplied).

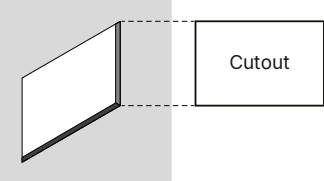
1.  Cut a rectangular hole in the panel to the correct size.
See [Panel cutout](#) for the dimensions of the cutout.
Panel thickness must be less than 10 mm (0.39 in).

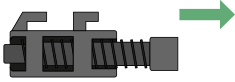
2.  Make sure that each fixing screw clamp is loosened to the position shown.
Do not remove the fixing screw clamp completely from the holder.

3.  Put the unit into the panel cutout.

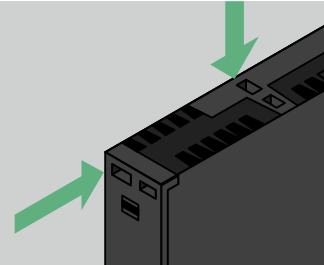
4.  Locate the holes for the fixing screw clamps on the unit.

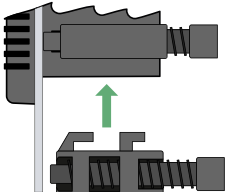
5.  Put each fixing screw clamp into the mounting holes.

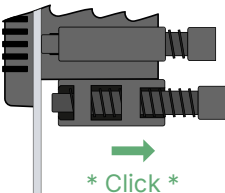
6.  Slide each fixing screw clamp into position.
* Click *

7.

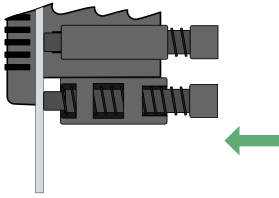

Turn the fixing screw clamp until the unit is secure to the panel surface.

Do not exceed the recommended torque of 0.1 N·m (1.3 lb-in).

3.3.4 iE 7 Display cable strain relief

Cable tie slots

The iE 7 Display has two cable tie slots at the bottom of the display. For installations that may be subject to high vibrations, you must secure both the USB and DisplayPort cables using cable ties.

The maximum cable tie width is 4.5 mm (0.18 in).

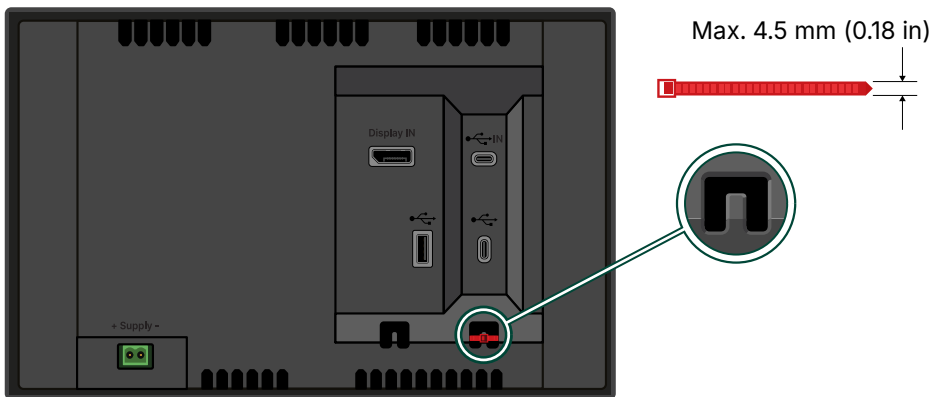

3.4 Hardware modules

3.4.1 Change supplied configuration

The controller is normally supplied with the necessary hardware modules already mounted.

However, it is possible for you to add or replace the hardware modules before wiring and commissioning. If you need to add a hardware module, you must use the first empty slot from the left of the rack.

Make sure that changing the configuration does not affect any maritime classification societies approvals.

NOTICE



Correct handling of modules

Failure to follow these instructions could lead to damage to the modules.
Read and follow the instructions to avoid damage to the modules.



CAUTION



Protecting equipment: No hot swapping

The rack must not be powered during the procedure. Make sure that any power supply is disconnected BEFORE replacing any modules.

NOTICE



Electrostatic discharge

During manufacturing and testing, the products have been kept in static shielding bags, and all personnel handling the products have been protected against static electricity and the subsequent ESD (electrostatic discharge).

Be sure to carry a connection to earth when handling our PCBs.

NOTICE



Torque damage to equipment

Do not use power tools during the installation/replacement. Too much torque damages the equipment.
Follow the instructions for the correct amount of torque to apply.

3.4.2 Rack slot requirements

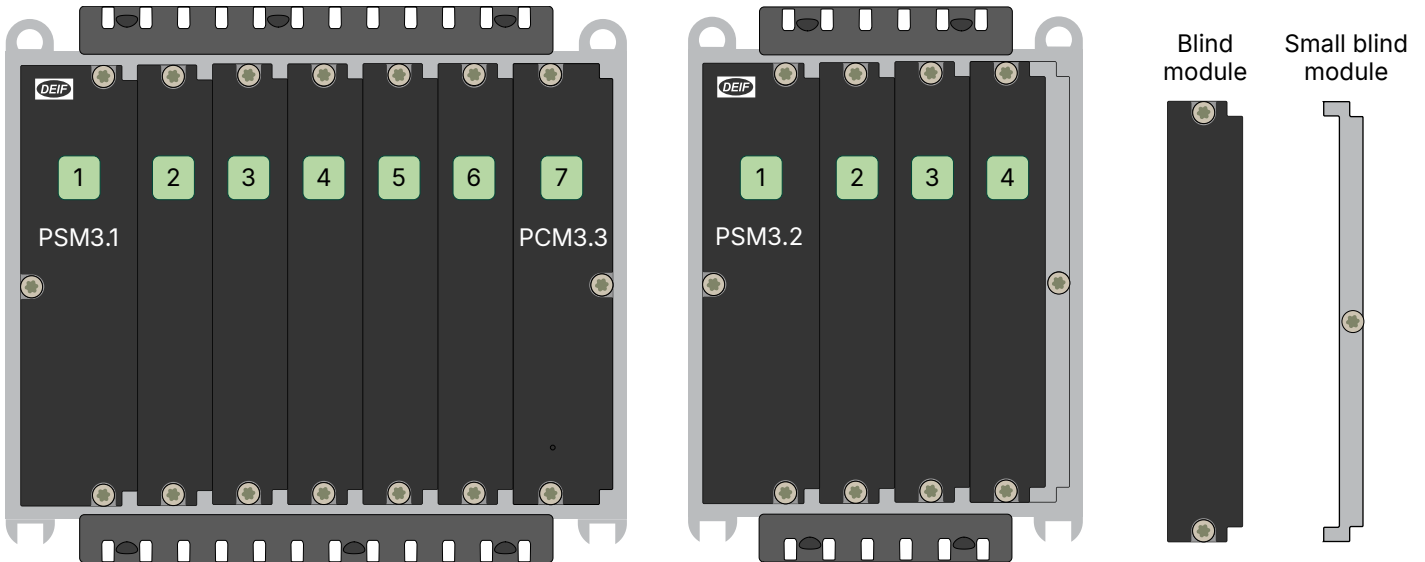

Modules can be installed in either rack R7.1 (7 slots) or R4.1 (4 slots). The modules can be arranged in any order in the rack, but must comply with these requirements.

R7.1 (7 slots)		R4.1 (4 slots)	
Controllers	Extension racks	Controllers	Extension racks
Slot 1 must have the PSM3.1 .	Slot 1 must have the PSM3.2 .	Slot 1 must have the PSM3.1 .	Slot 1 must have the PSM3.2 .
Slot 7 must have the PCM3.3 .	Other modules can be used in slot 7 but must have the small blind module .	Slot 4 must have the PCM3.3 .	Other modules can be used in slot 4 but must have the small blind module .
Blind modules (blank faceplates) must be installed over empty slots to protect the rack.			

Order of the modules

All other hardware modules must installed from left to right from slot 2 onwards without empty slots between modules.

There can only be adjacent empty slots between the last module and the **PCM3.3** or end of the rack.

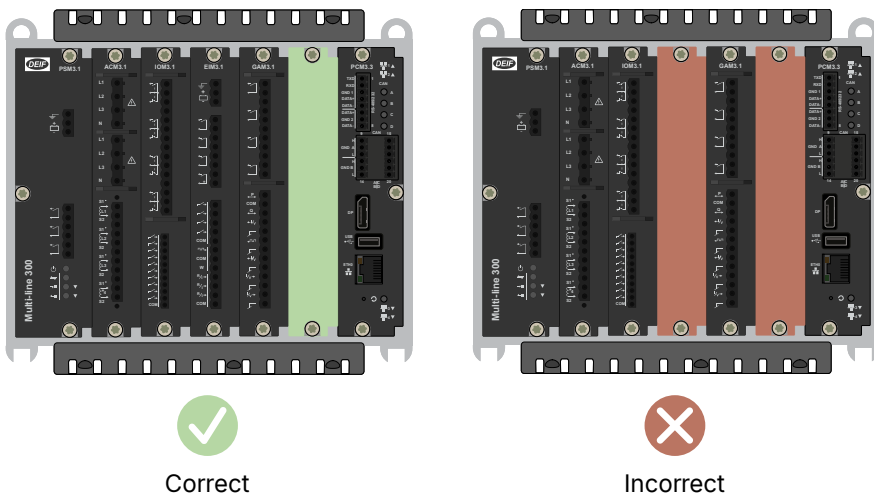

If slots are empty between the hardware modules, the modules after the empty slot(s) **cannot communicate** with the **PCM3.3** module.

3.4.3 Change hardware modules

Each module is fastened to the rack with TX20 screws.

These should be loosened before the extraction handles are used to lift the module free of the rack.

They do not remove completely from the hardware module.

Hold the module by the faceplate. Do **not** touch the PCB.



More information

See [Maintenance](#) for how to change the PCM battery.

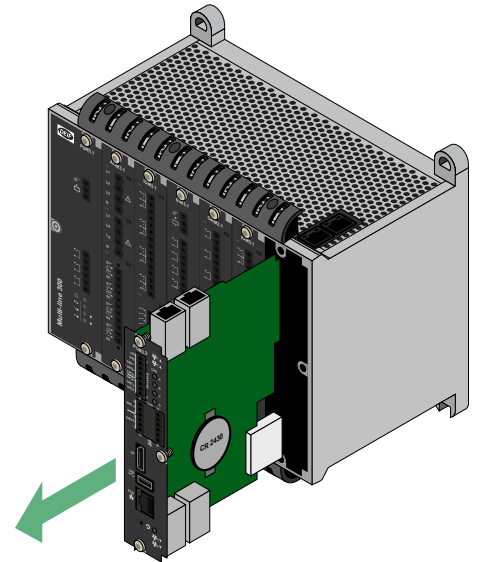

3.4.3.1 No hot swapping modules



DANGER!

Do not hot swap modules



It is not allowed to hot swap any modules. Hot swapping modules can be extremely dangerous to both personnel and the equipment.

Make sure the system is shutdown and power supply has been isolated and switched off.



Isolate the power supply.



Protect the modules against static discharge.



Do not alter state during installation.



Avoid touching the PCB or terminal pins.



More information

See [Warnings and safety](#) for full details of all precautions to take during installation.

3.4.3.2 Remove hardware modules

1. Protect the hardware modules against static discharge.



It is recommended to use a wrist strap connection to protect against Electrostatic discharge (ESD).

Test the resistance of the wrist strap and the wrist strap connection. **Do not continue** if the wrist strap connection is faulty. Use the wrist strap at all times while installing or uninstalling any modules.

2. The controller **must not be powered**.



Disconnect all power supplies to protect the hardware modules and personnel.

3. Remove all terminal blocks, and make sure that there are no wires in the way of removing the hardware module.

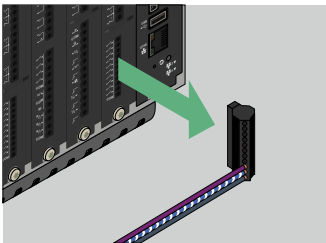

For PSM or PCM modules, disconnect any Ethernet cables from the top and bottom.

4. Loosen the module faceplate screws with a TX20 screwdriver.

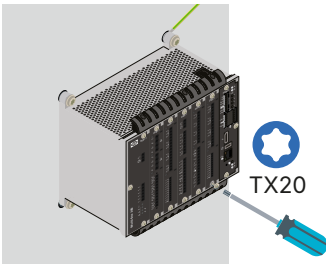

5. Do not force the screws to unscrew completely.

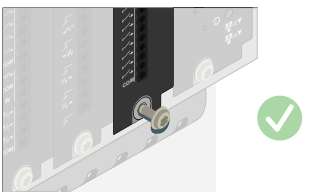

The screws are built-in and should remain attached to the faceplate.

6. Use pliers or your fingers to pull the faceplate screws, and carefully slide the hardware module out of the rack.

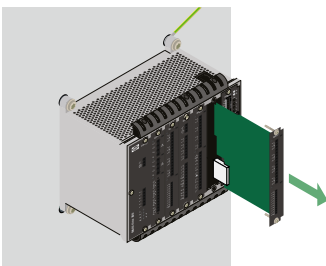

7.

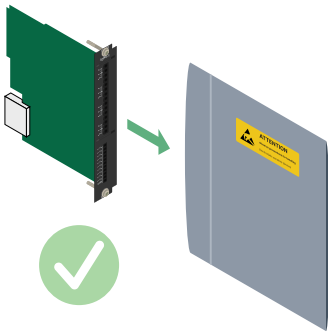

Hold the module by the faceplate.

Do **not** touch the PCB.

Put the hardware module in an ESD protective package when not installed in the rack.

3.4.3.3 Mount hardware modules

1. Protect the hardware modules against static discharge.



It is recommended to use a wrist strap connection to protect against Electrostatic discharge (ESD).

Test the resistance of the wrist strap and the wrist strap connection. **Do not continue** if the wrist strap connection is faulty. Use the wrist strap at all times while installing or uninstalling any modules.

2. The controller **must not be powered**.



Disconnect all power supplies to protect the hardware modules and personnel.

3. Open the ESD protective package, and remove the new module, hold it only by the faceplate.

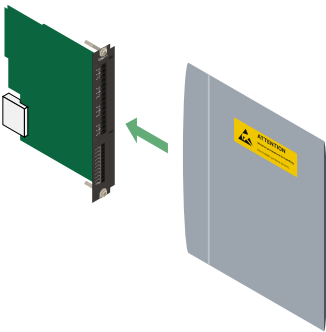

4. Slide the module into the correct slot (it should slide in easily).

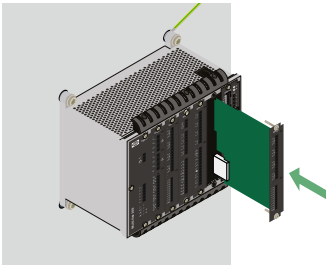

5. Tighten the screws on the module faceplate with a TX20 screwdriver.

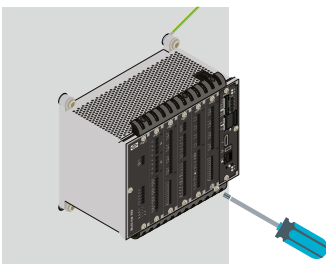

Do not exceed the recommended torque of 0.5 N·m (4.4 lb-in).

6.

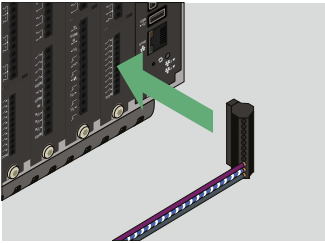

Replace all terminal blocks.

For PSM or PCM modules, replace any Ethernet cables to the top and bottom.

7.



If the rack is not mounted, return the rack to its protective packaging.

4. Wiring the equipment

4.1 About the wiring

4.1.1 Technical specifications

You can find all of the technical specifications in the Data sheet:

- [iE 350 Data sheet](#)
- [iE 350 Marine Data sheet](#)
- [iE 350 PLC Data sheet](#)

4.1.2 Encoding pins for terminals

Use encoding pins to prevent the terminal blocks from being mounted incorrectly. Make sure the terminal wiring was not swapped around during the installation, as this could lead to dangerous situations. We strongly recommend that you use encoding pins on both ACM3.1 and ACM3.2 for both voltage and current respectively. You can also use encoding pins on other terminals and modules.

For safety reasons the encoding pins should not be reused. Once they are installed it is difficult to remove the pins without damaging the equipment.

Optional installation equipment

Tool	Function
Long nose pliers	Improves the handling and placement of the voltage encoding pins.



More information

See [Voltage encoding pins for ACM3.1](#) and [Current encoding pins for ACM3.2](#) for how to install the encoding pins in the module.

4.1.3 Wire up from left to right

We recommend that you wire up the controller (or extension rack) from left to right. As the wiring connects to the left side of each 45° terminal block, they may otherwise extend over and obstruct the module to the left.

4.1.4 Default functions

The default application, for the controller type and licence, includes preassigned functions on specific modules and terminals. Many of these functions can be reassigned to other modules or terminals as needed.

The default functions are shown on the [typical wiring diagrams](#) for each application.

4.1.5 Supervised binary inputs

You can configure analogue inputs to operate as supervised binary inputs (dry contact). Analogue inputs used for supervised binary inputs should be configured using the function type **Supervised binary**.

Use an analogue input curve to define the supervised binary input. The supervised binary input curve is a step function. That is, the curve consists of a horizontal line (with the value 0 or 1), a vertical line (the point where the curve changes), and another horizontal line (with the value 1 or 0).

To avoid instability, configure the curve so that the change point is far away from the input closed and open values.

If the analogue input measurement corresponds to a function input that is not zero, then the controller uses one as the function input.

4.2 Typical wiring

4.2.1 About the typical wiring

Some of the default terminal connections are optional, configurable, or the function may be achieved using other terminals.

Wiring

Only use the terminal blocks supplied by DEIF. Do not use substitutes.

Keep the foil cover placed over the top of the controller as long as possible to avoid damage to the controller.

Specifications



More information

See the **Data sheet** for the electrical specifications.

Default wiring for controller types

This section also provides drawings of the default wiring for the relevant hardware modules for each controller type.

Each controller type is delivered with the inputs and outputs configured according to the default configuration.

After you install a PCM card that has been delivered to you as a spare part from DEIF, the controller is configured according to the default configuration. The controller has to be configured to match the system configuration after installing the hardware module.

Always check that the controller configuration matches your system configuration after you replace hardware modules.

Custom configurations

You can connect the inputs and outputs to other terminals than specified in the default configuration. We recommend that you keep a record of where the system deviates from the default configuration.

In addition to the default wiring, the designer may specify inputs and outputs, according to the specific system's requirements. These may use the available configurable connections in the basic controller type's hardware, and/or the connections from additional installed modules. These connections are not included in the default wiring drawings, but must be shown on the designer's drawings for the system.

If there is space in the rack, you can mount additional modules for additional inputs and outputs. The details of these connections are specific to the installation, and must be included in the system designer's drawings.

Minimum hardware configuration

The controller minimum hardware is described below. ACM3.2, IOM3.1, IOM3.2, IOM3.3, IOM3.4, GAM3.1, GAM3.2 and EIM3.1 hardware modules can be ordered and installed in the empty slots. Spare hardware modules may also be ordered for installation in the field.

Table 4.1 Minimum hardware configuration in R7.1 *

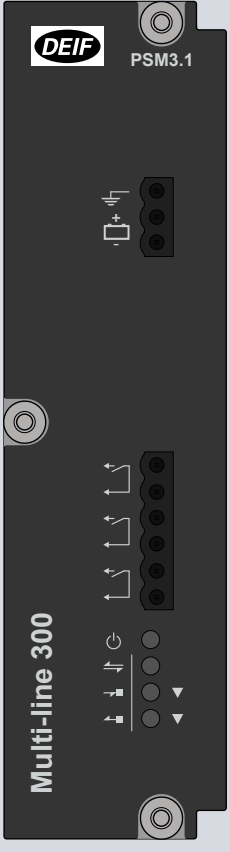
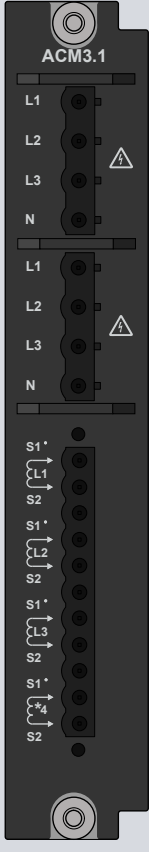
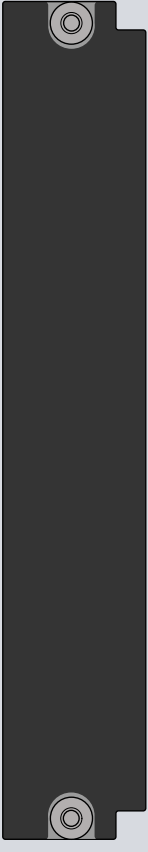
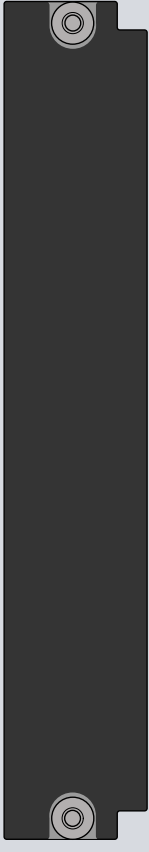
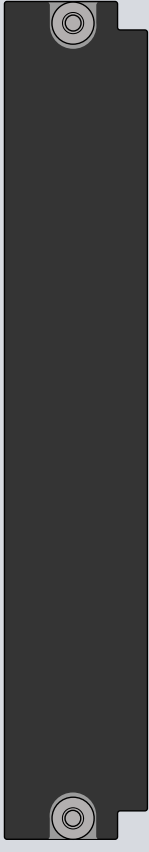
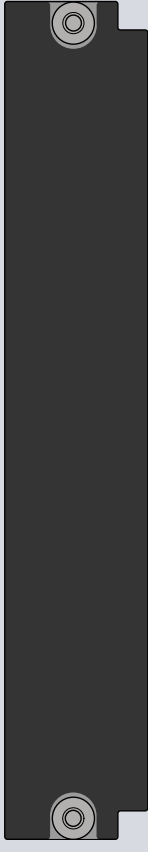
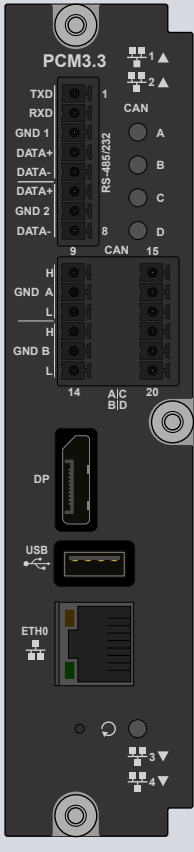
Slot 1	Slot 2	Slot 3	Slot 4	Slot 5 *	Slot 6 *	Slot 7 *
PSM3.1	ACM3.1	Blind module	Blind module	Blind module	Blind module	PCM3.1
Power supply module	Alternating current module					Processor and communication module
						

NOTE * Alternatively, use a 4-slot rack (R4.1). Slots 5, 6 and 7 are only available in a 7-slot rack (R7.1).

4.2.2 IE 350

4.2.2.1 SINGLE genset controller wiring

SINGLE genset controller with mains breaker

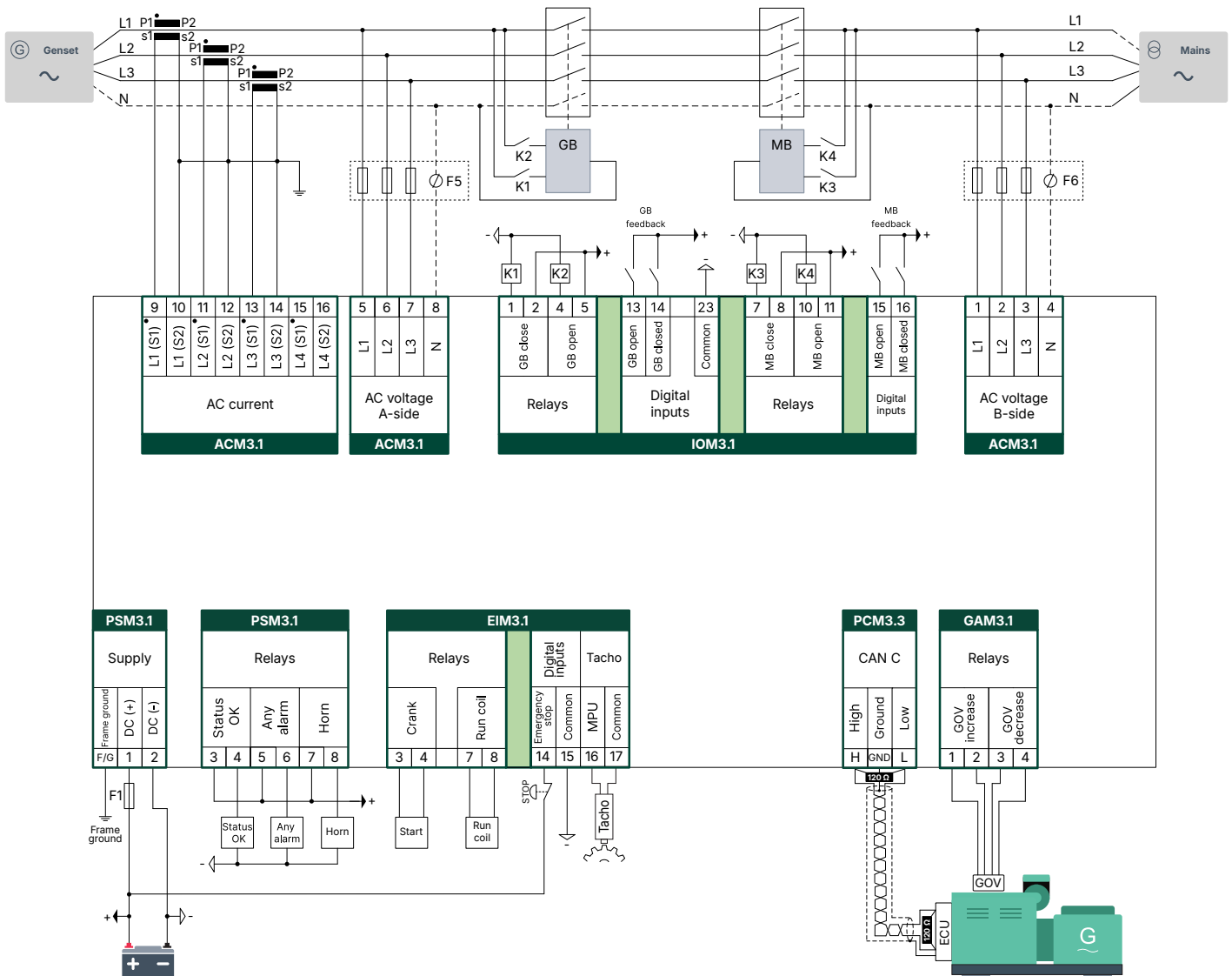

SINGLE genset controller with no mains breaker

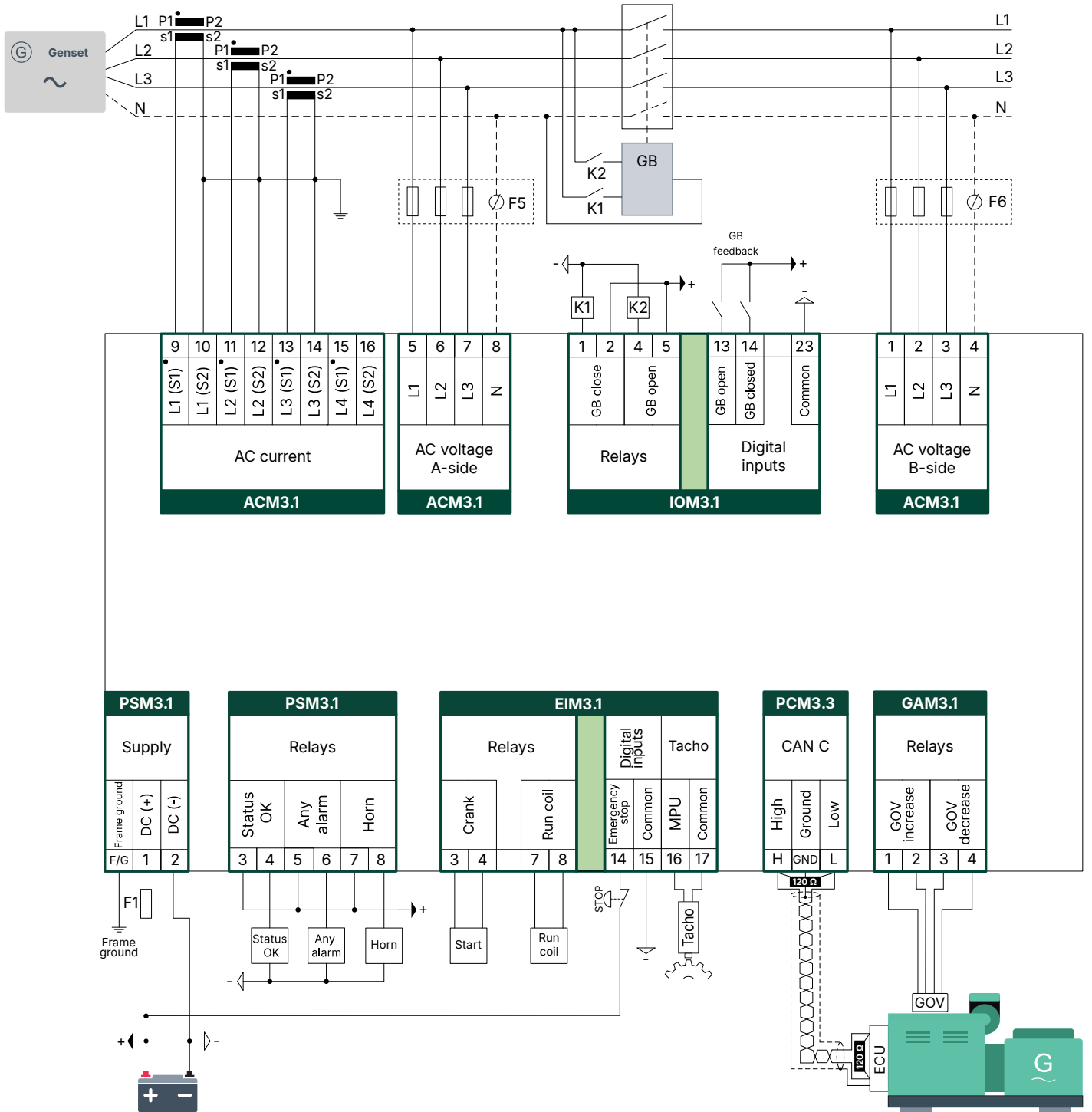

4.2.2.2 GENSET controller wiring

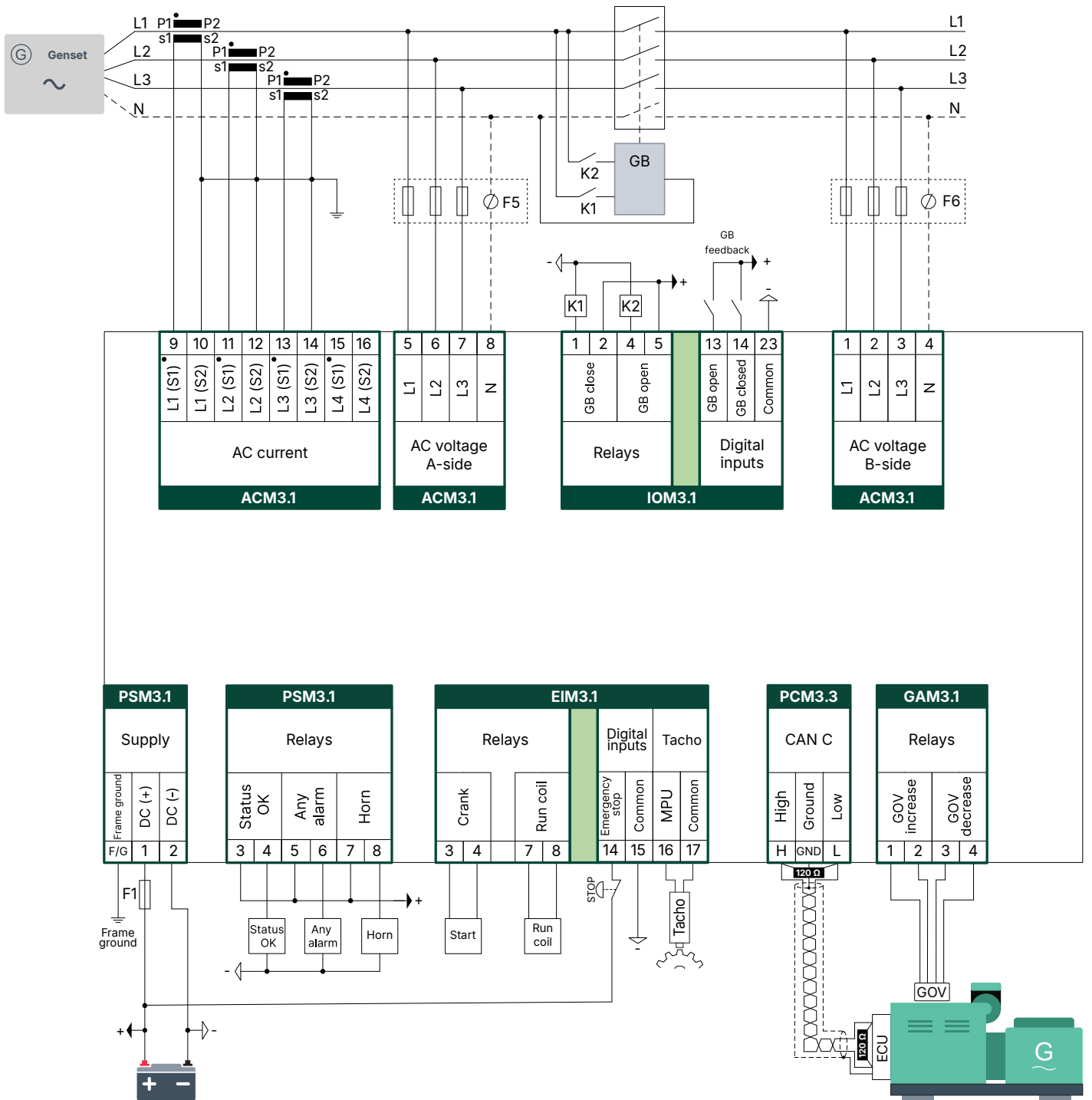

4.2.2.3 MAINS controller wiring

MAINS controller with tie breaker

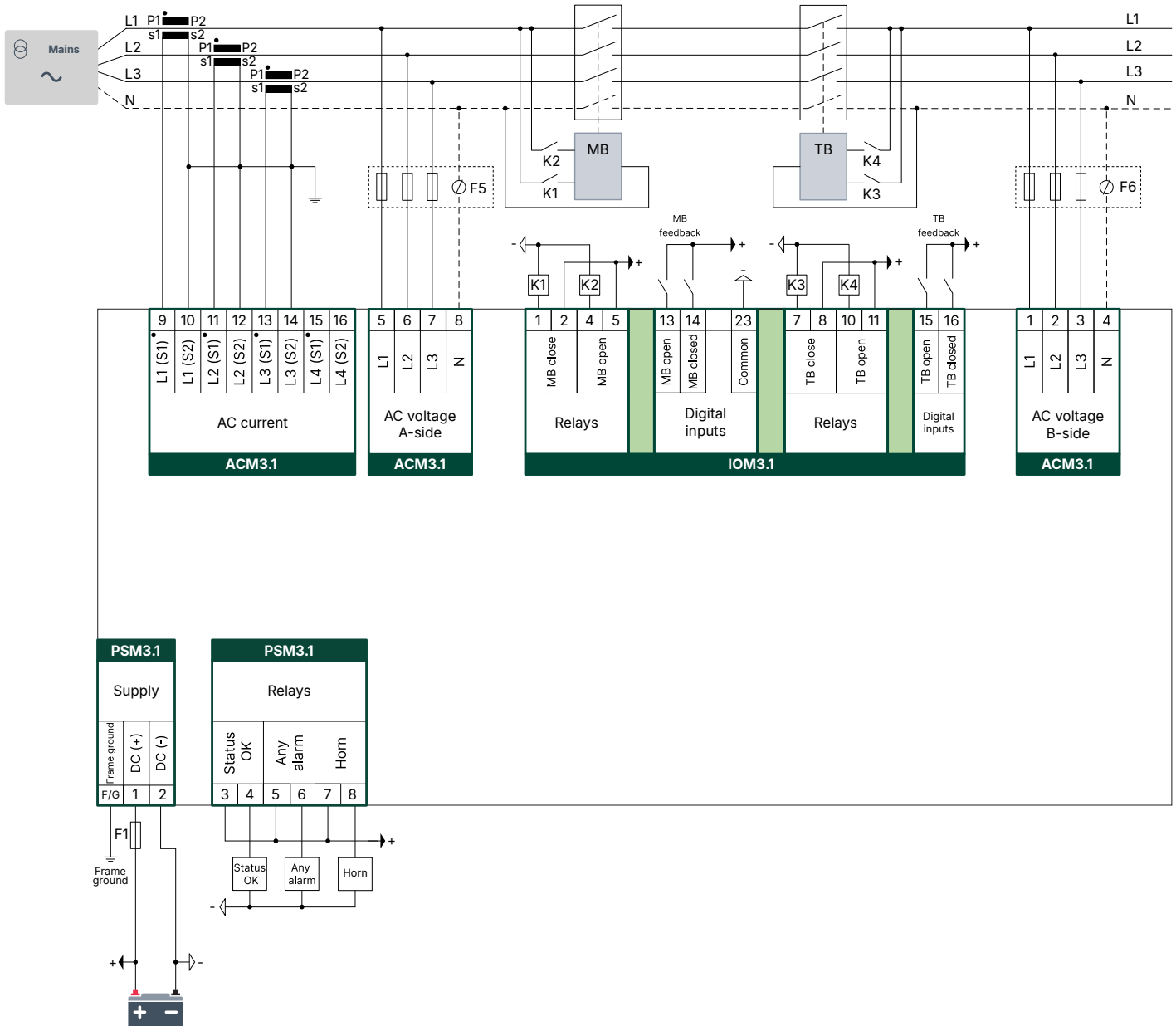

MAINS controller with no tie breaker

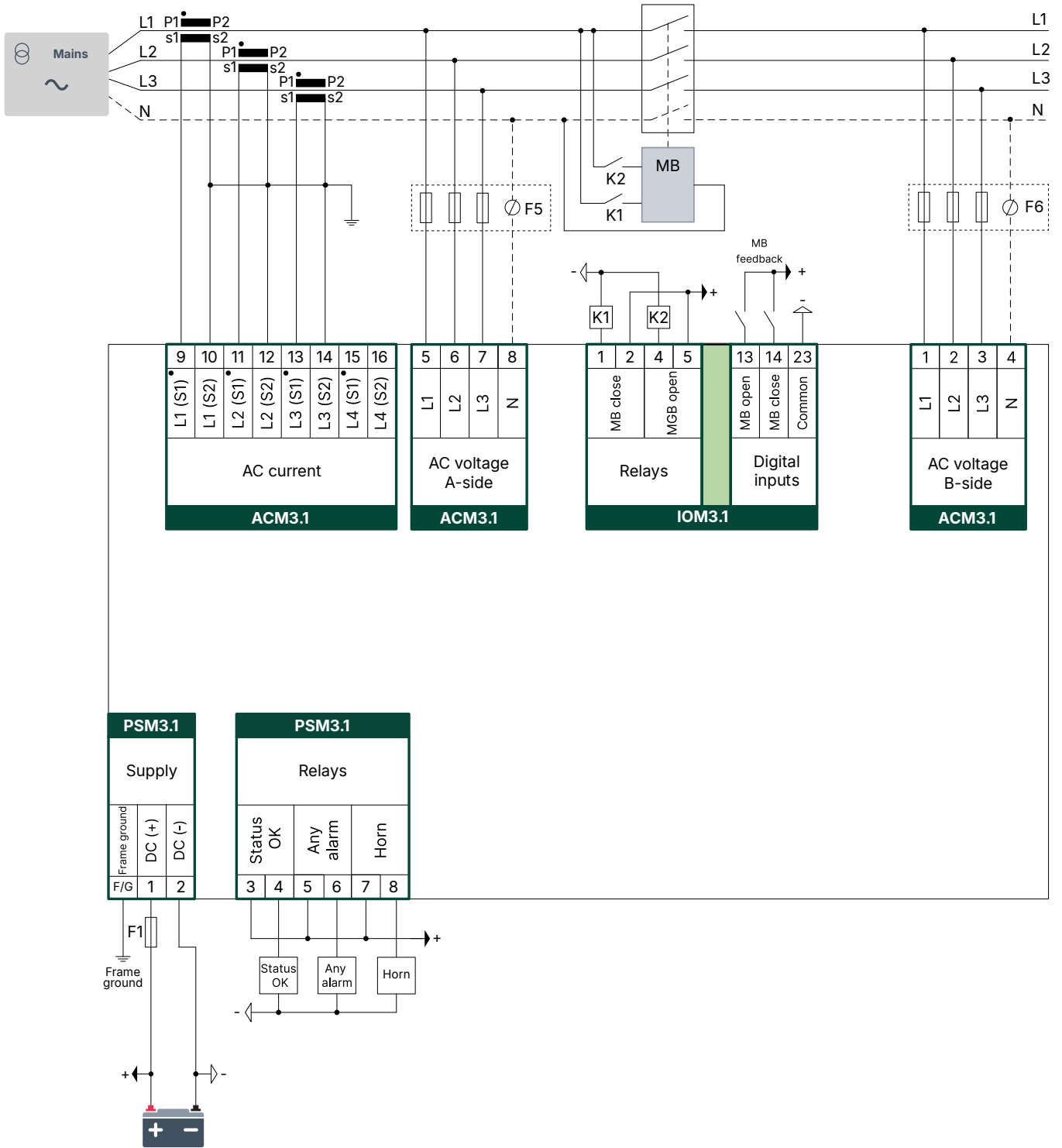

4.2.3 iE 350 Marine

4.2.3.1 GENSET controller wiring

Load sharing

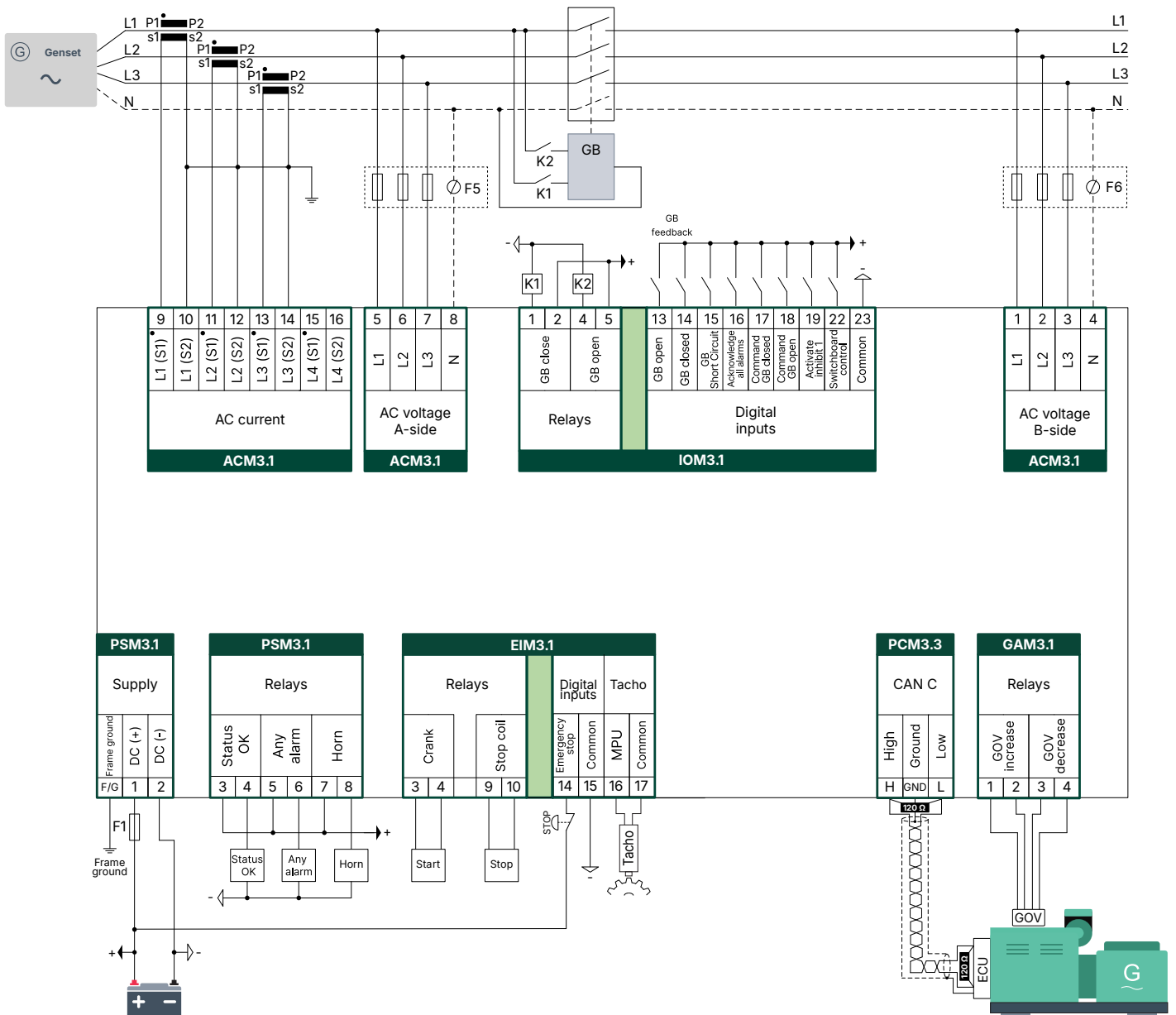

Power management

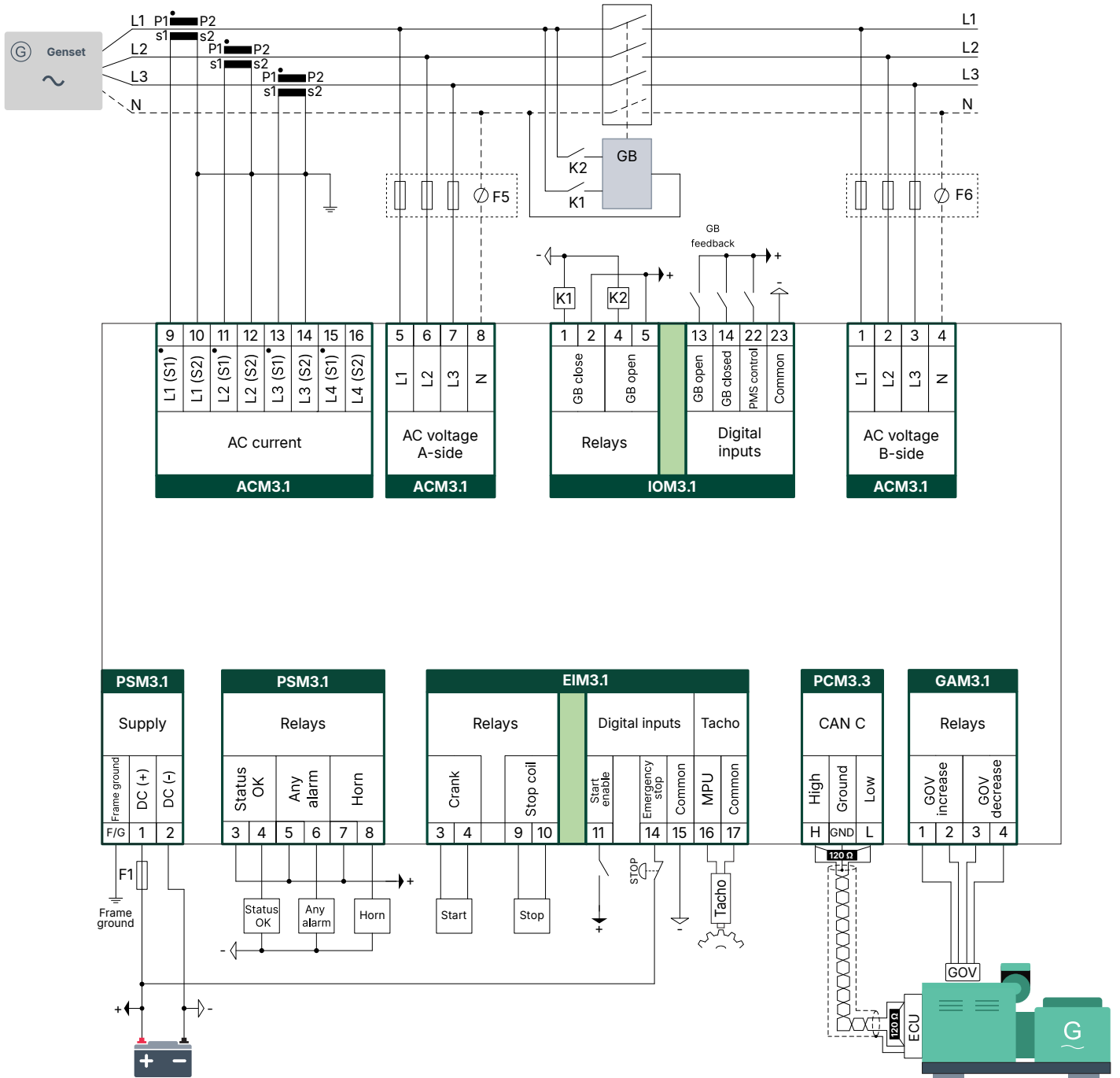

4.2.3.2 EMERGENCY genset controller wiring

Power management

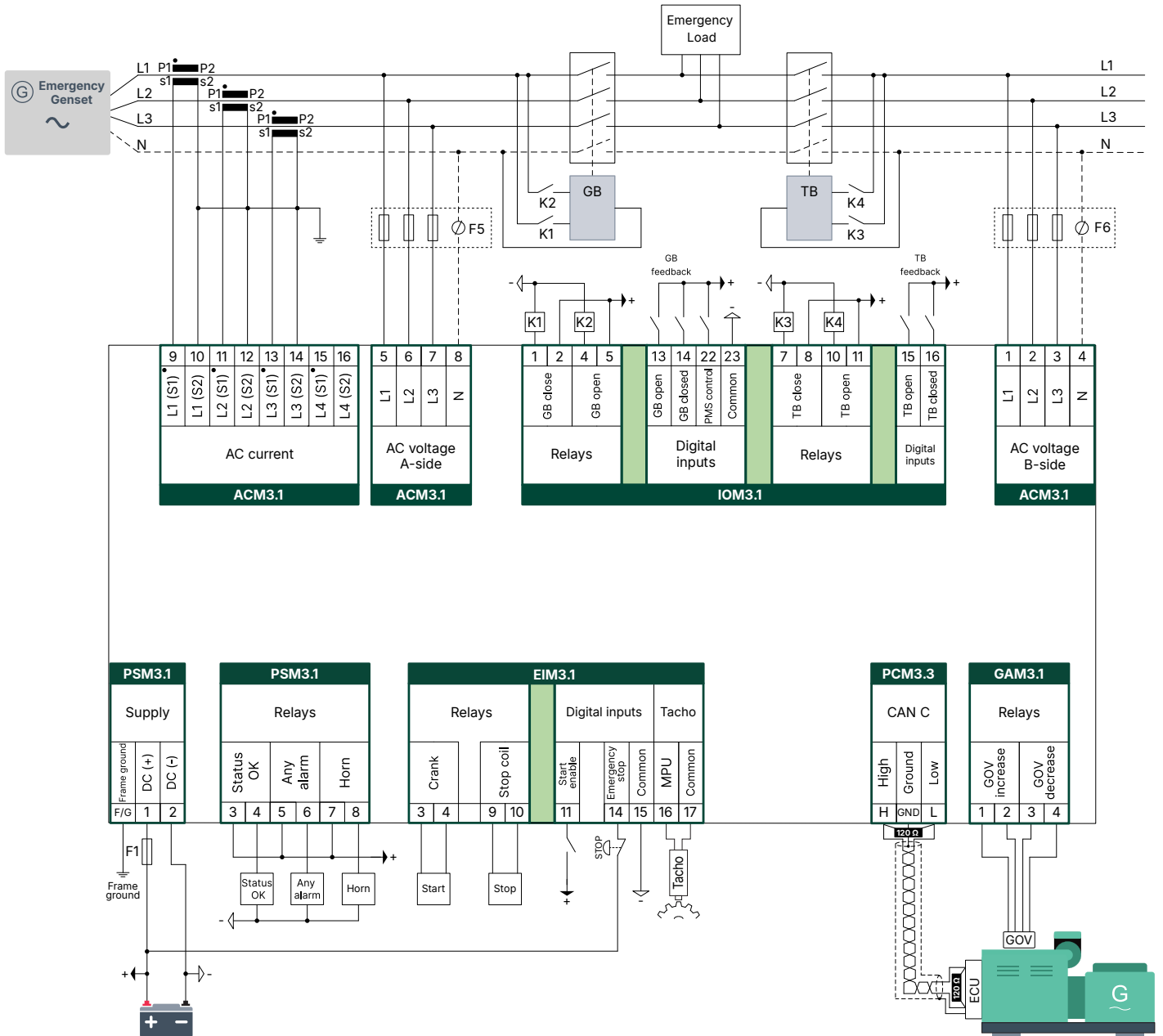

4.2.3.3 HYBRID controller wiring

Load sharing

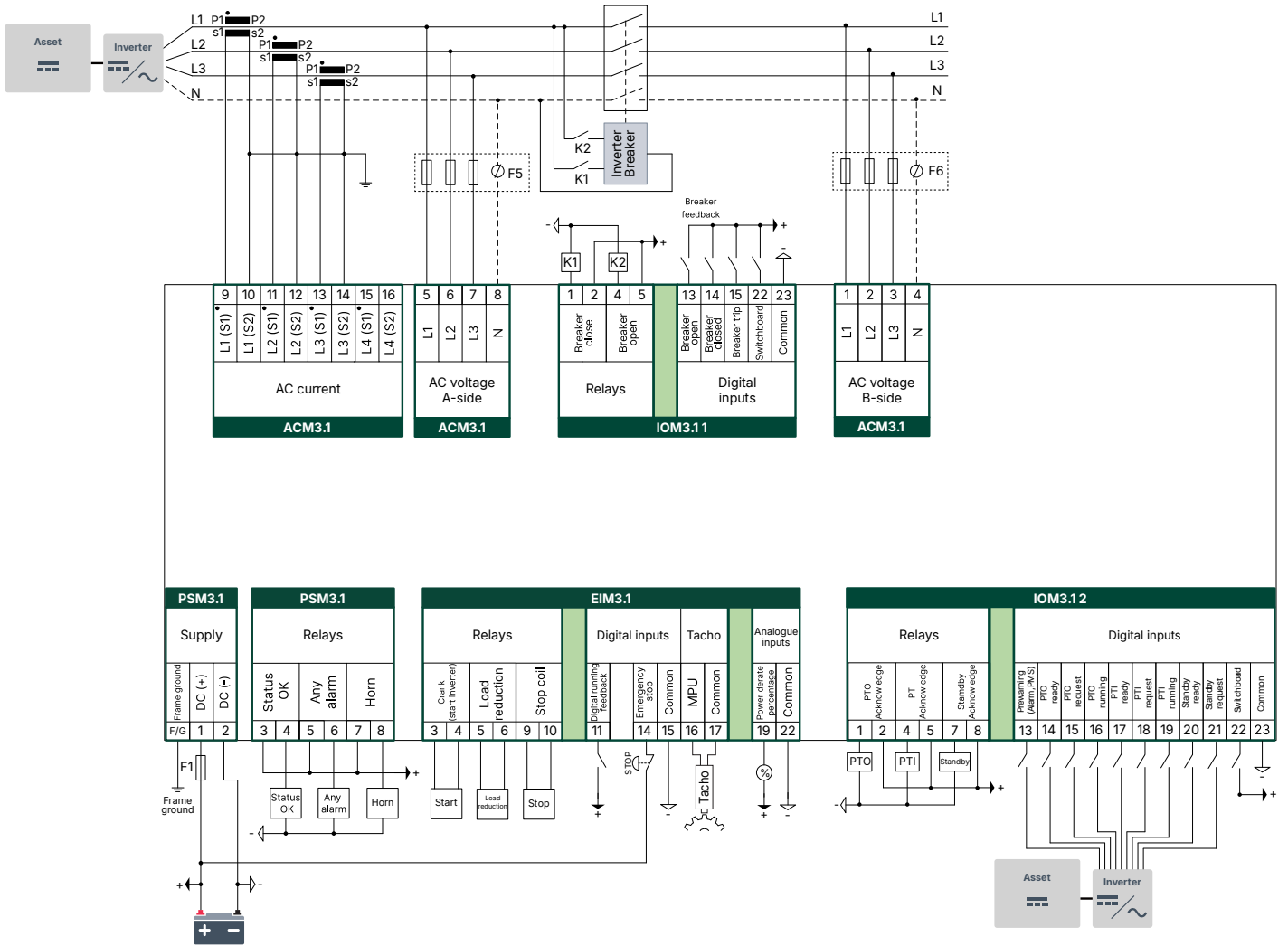

Power management

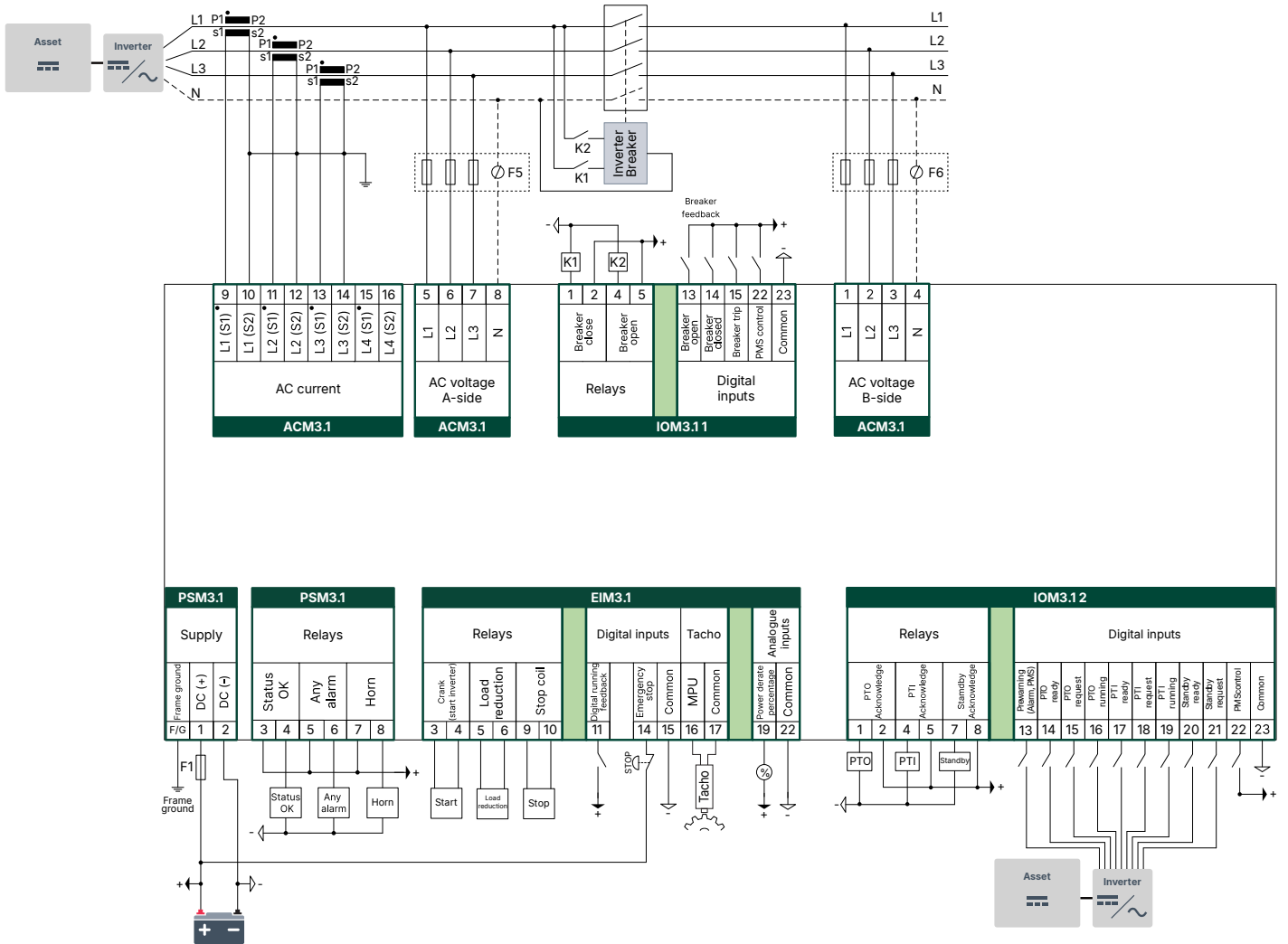

4.2.3.4 SHAFT controller wiring

Load sharing

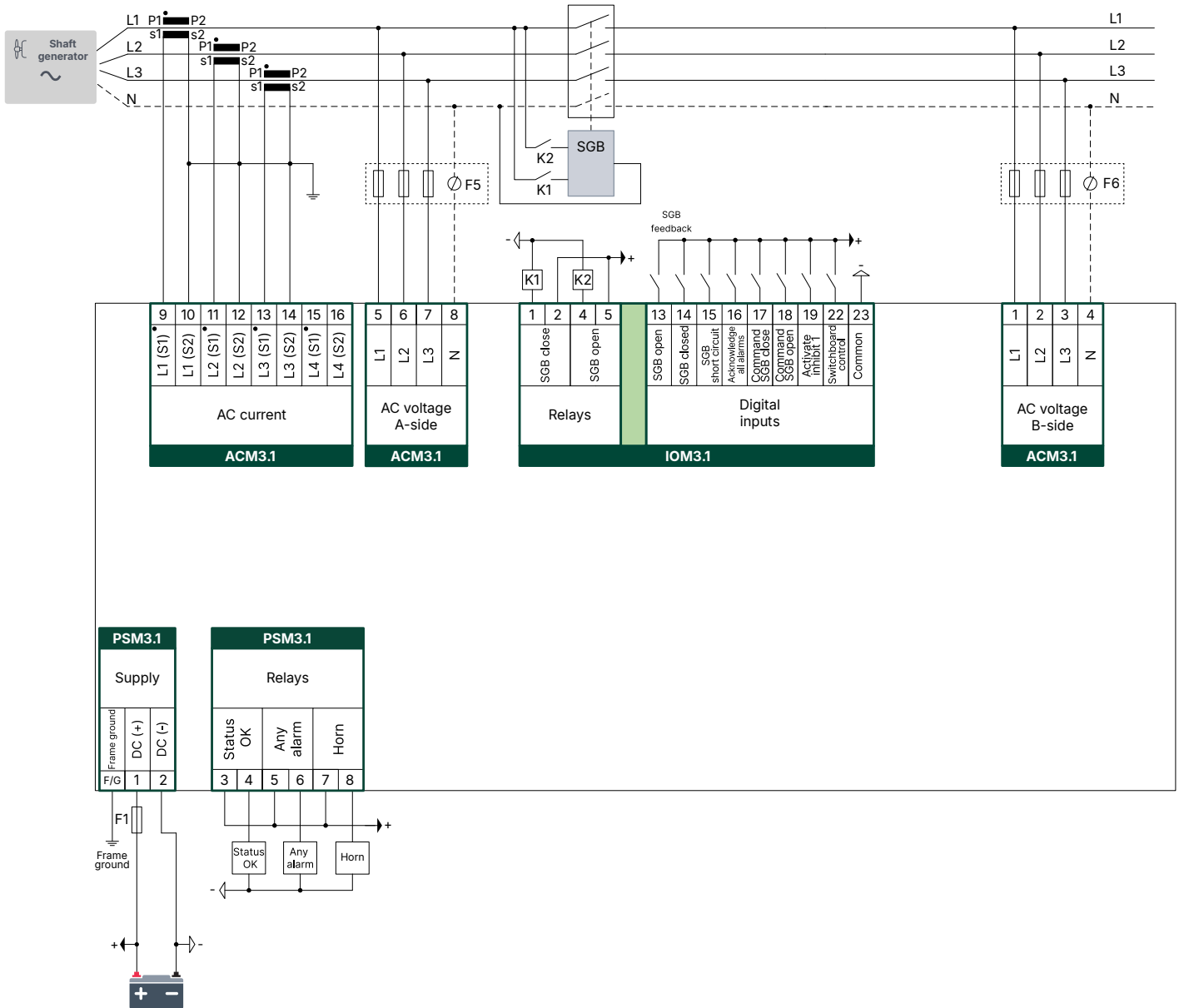

Power management

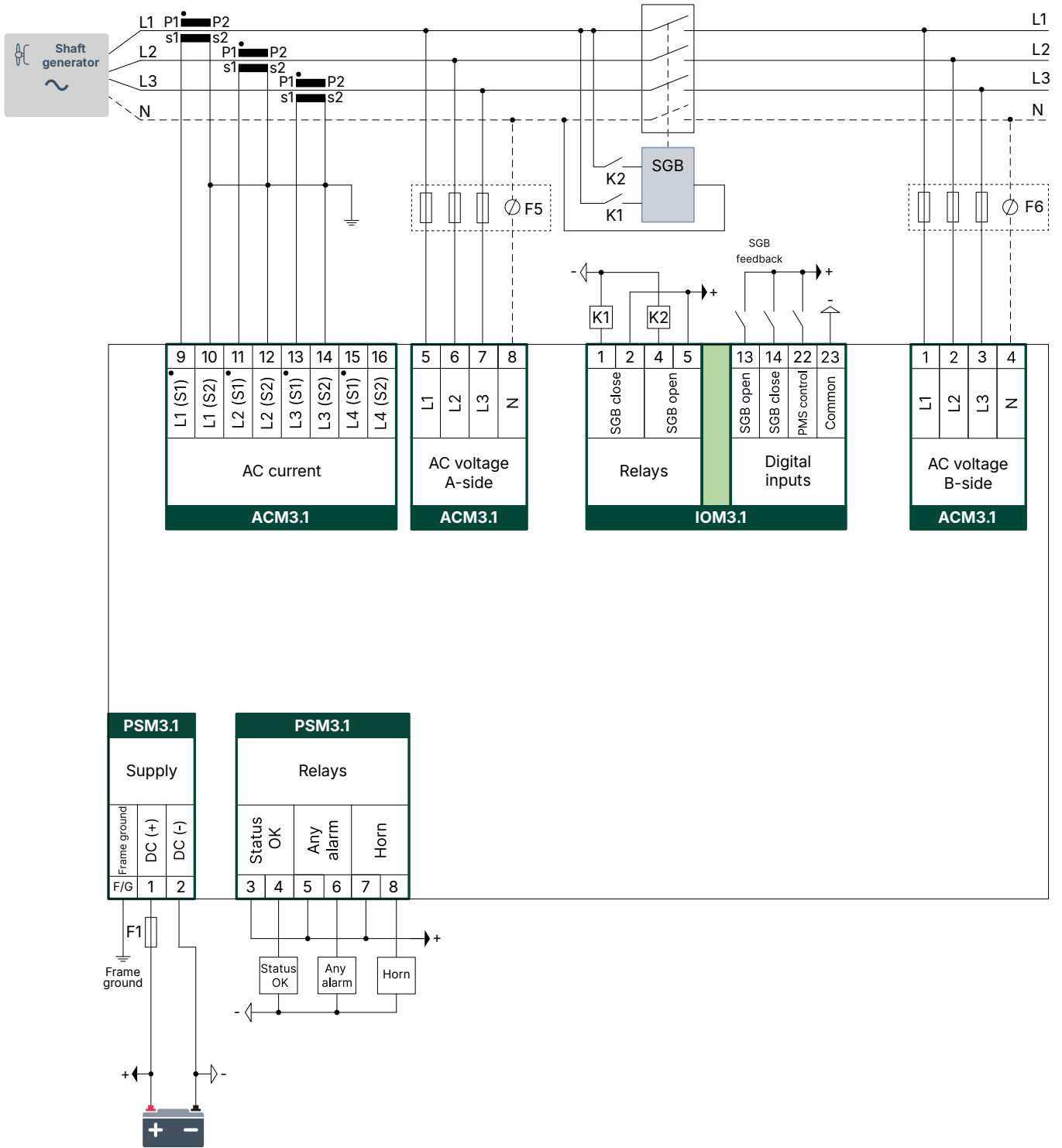

4.2.3.5 SHORE connection controller wiring

Load sharing

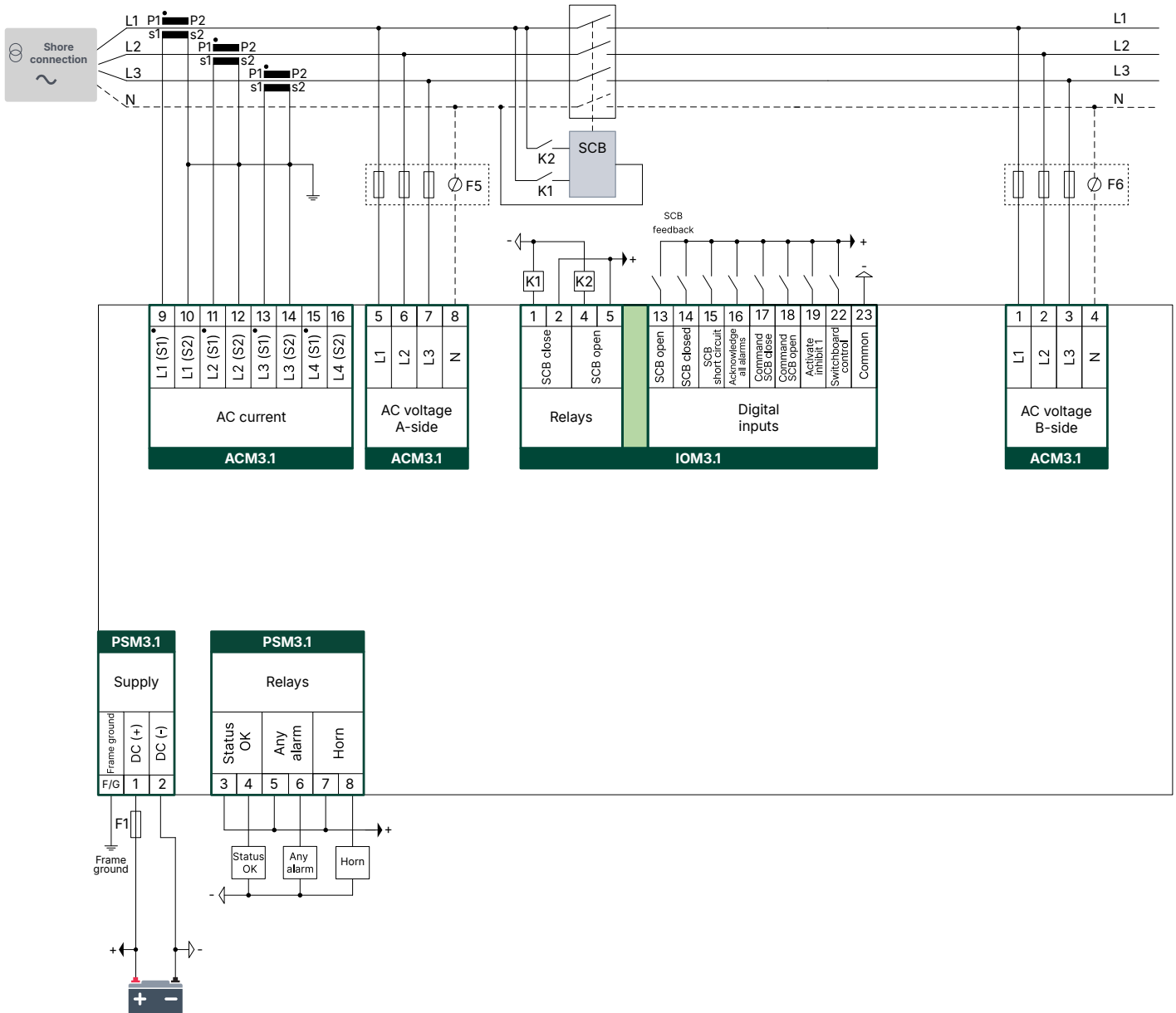

Power management

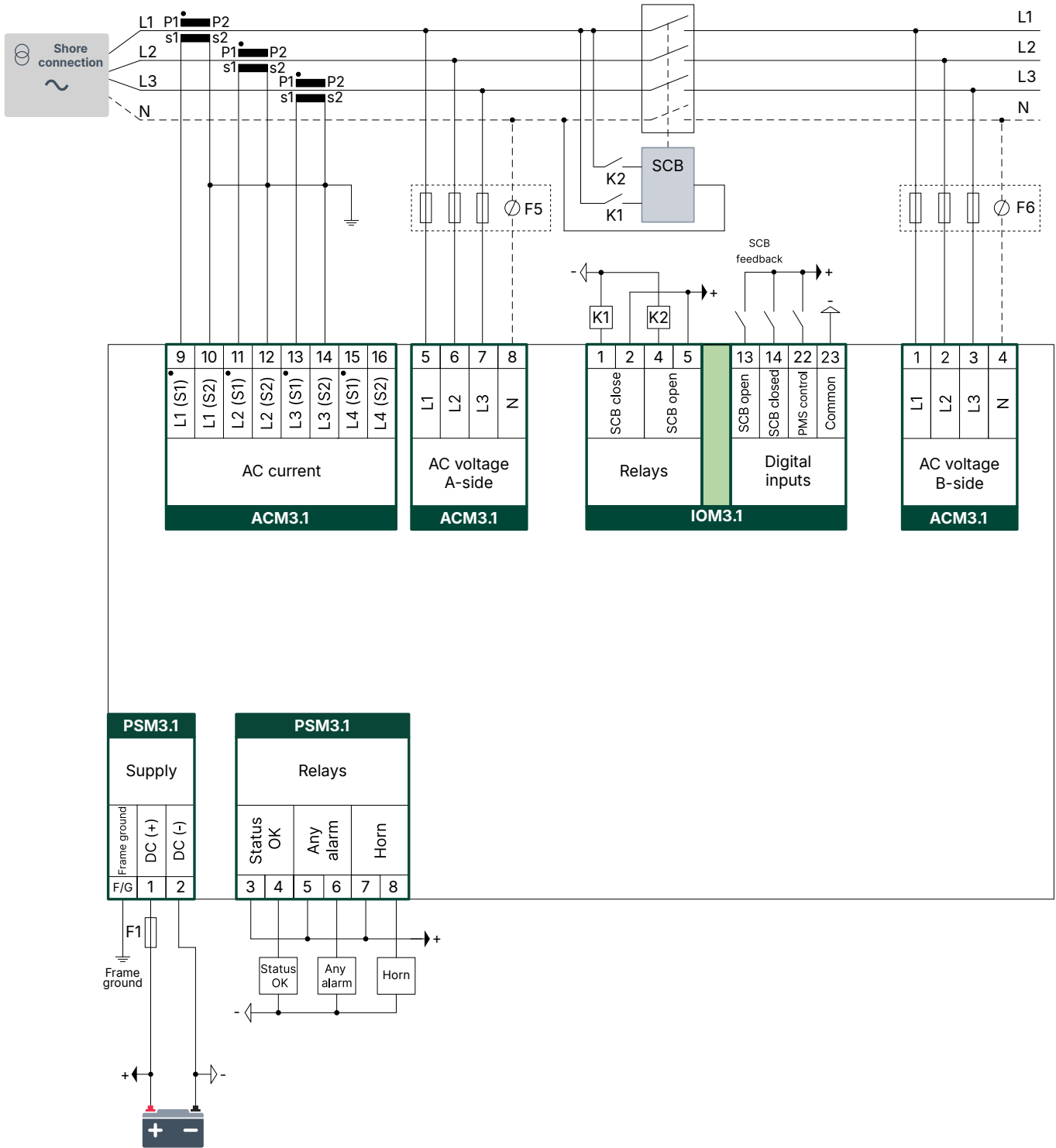

4.2.3.6 BUS TIE breaker controller wiring

Load sharing

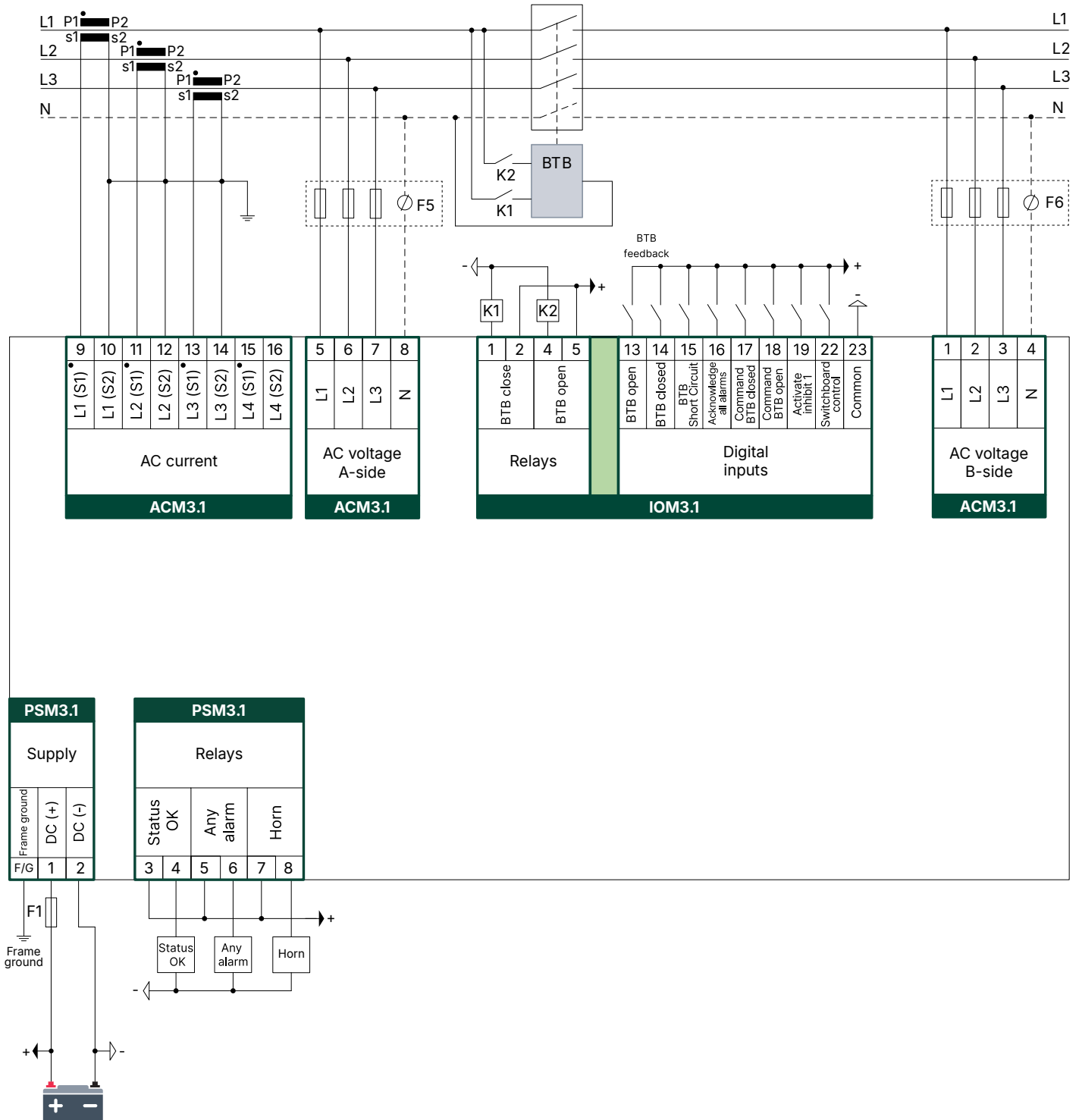



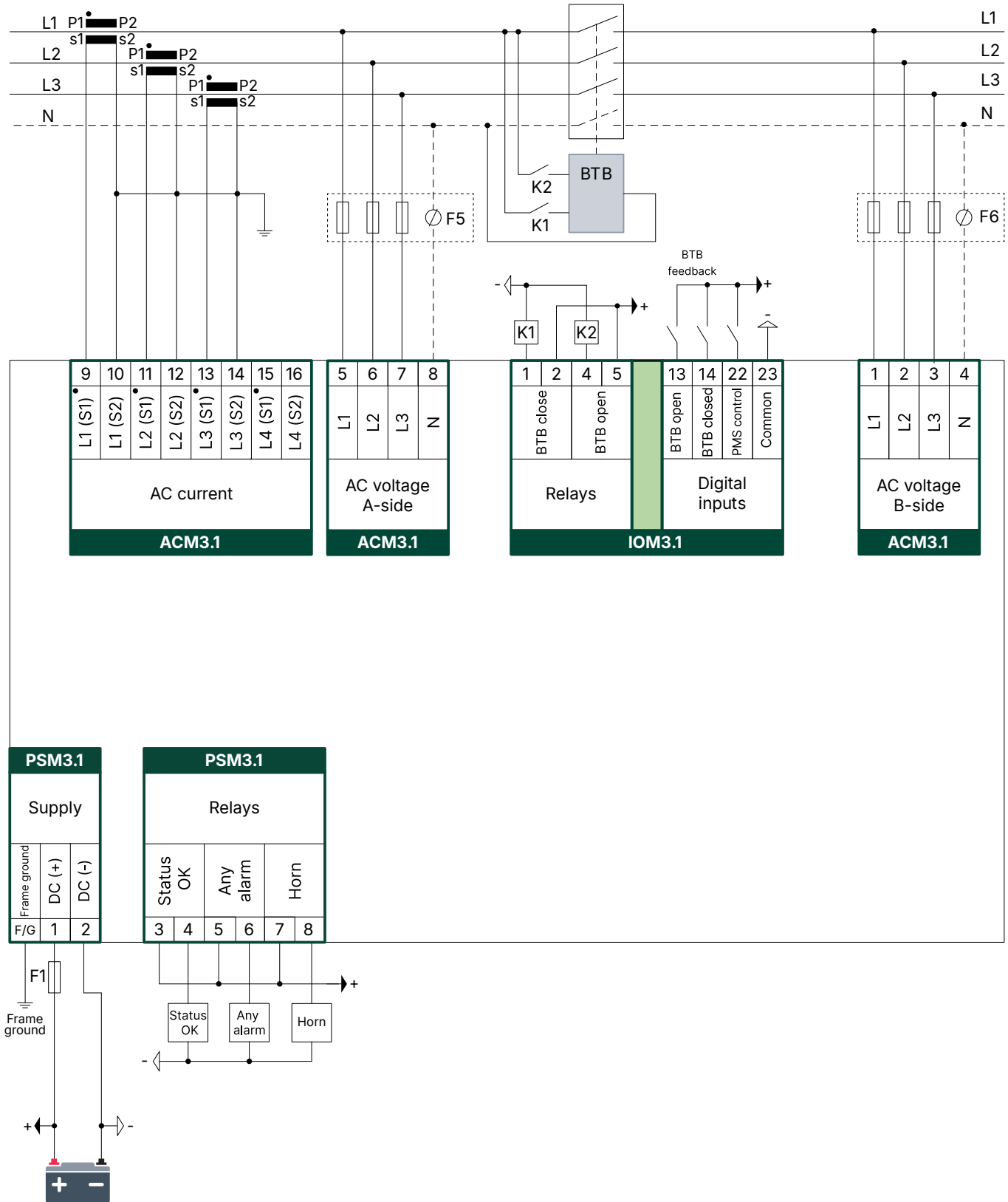





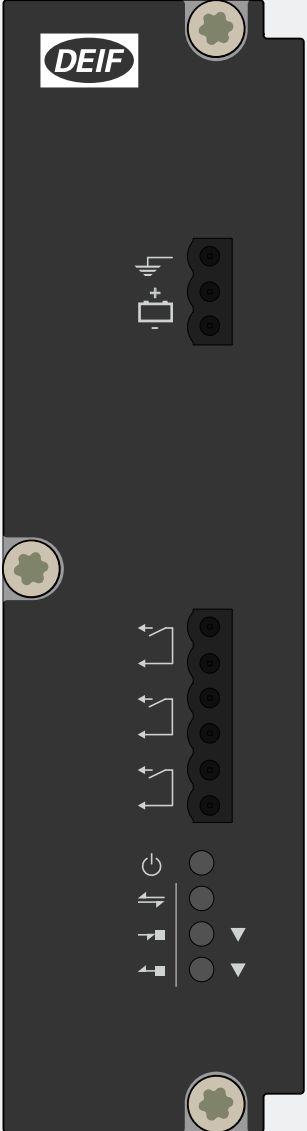



Power management



4.3 Power supply module PSM3.1

4.3.1 PSM3.1 terminal connections

	Term	Symbol	Name	Type	Default
	F/G		F/G	Ground	Frame ground
	1		+	12 or 24 V DC (nominal)	Power supply
	2		-	0 V DC	
	3		Normally open	Relay output (30 V DC and 1 A)	... > Status OK *
	4		Common		
	5		Normally open		
	6		Common		... > Any alarm (Configurable)
	7		Normally open		
	8		Common		... > Horn 1 (Configurable)
	IN		Internal communication input **	RJ45 (bottom of rack, top port)	Input *
OUT		Internal communication output **	RJ45 (bottom of rack, bottom port)	Output *	

NOTE * Default function cannot be changed.

** Internal communication connections are only for communication to extension racks.

4.3.2 Frame ground wiring

Create a protective earth:

1. Connect the frame ground terminal to the protective earth connection.
2. Connect the frame ground terminal to the cabinet.
3. Connect the rack to the cabinet.

The frame ground is connected to the power supply terminals through transient voltage suppression diodes (transorbs). In order to protect the frame ground and power supply, max. 36 V is allowed between the frame ground and the power supply terminals.

4.3.3 Power supply wiring

Connect the power supply (+) to the 12 or 24 V DC power supply, and the power supply (-) to the 0 V DC power supply.

NOTICE

Negative power supply terminal

Do not wire the negative power supply terminal of the modules with independent power supplies (for example, PSM 3.1) to the single-phase ground. If the voltage between the power supply terminals and frame ground exceeds 36 V, the power supply terminals and the frame ground terminal will be damaged.

Recommended wiring for the power supply

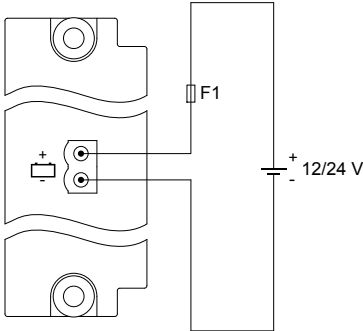

Incorrect wiring of the power supply

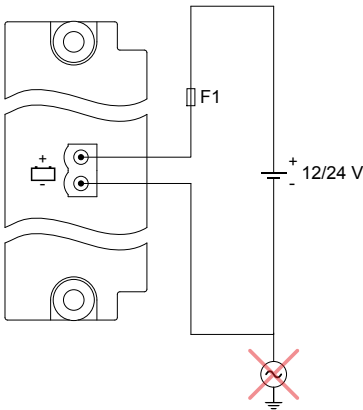

Backup power supply

The equipment does not contain a backup power supply. The power supply source must therefore include the necessary power backup.

Example of a power supply and backup connected to the power supply terminals

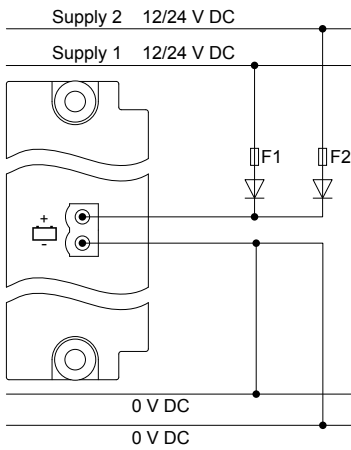

We recommend a 2 A time-delay fuse for 24 V DC and a 4 A time-delay fuse for 12 V DC for F1 and F2, and that the diodes are rated 50V or higher.

NOTICE



Nominal auxiliary voltage is 12 or 24V DC (8 to 36 V DC operating range).

If voltage drops are likely to appear, a 7 A time-delay fuse is needed.

4.3.4 Relay output wiring

The diagram shows the connection of the relay output to an external relay. There is no voltage on the external relay when the controller relay is open.

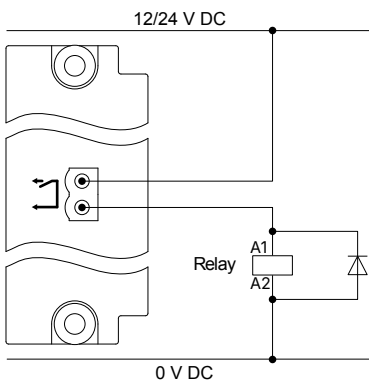

Use a diode size as recommended by the relay supplier.

You can swap the terminal connections around without affecting the performance.

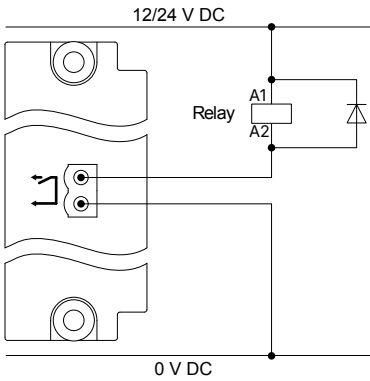



Install a freewheeling diode () to prevent a sudden voltage spike across the inductive load when the voltage source is removed.

4.3.5 PSM3.x EtherCAT connections

Extension racks are connected to controller with the EtherCAT internal communication ports on the PSM3.1 and PSM3.2. These ports are marked in red on the controller and extension rack. Do not use these connections for network communication between controllers, service PCs or switches.

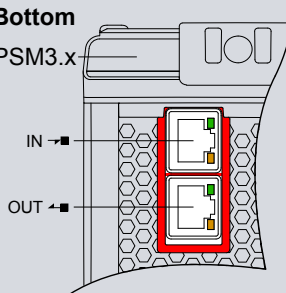
Table 4.2 Location of the EtherCAT communication ports

Symbol	Symbol	Port location	Notes
	IN 	Bottom of rack, top port	Internal communication: IN port from other rack
	OUT 	Bottom of rack, bottom port	Internal communication: OUT port to other rack

EtherCAT communication restrictions

The racks have an OUT port and an IN port for internal communication. The OUT port must always be connected to an IN port on the next extension rack.

- With 1 extension rack, you can optionally create a ring network by connecting the last extension rack back to the controller.
- With 2 or more extension racks, you must create a ring network by connecting the last extension rack back to the controller.
- Up to 5 extension racks can be connected to the same controller.
- The cables must not be longer than 100 metres from point-to-point.
- The cables must meet or exceed the SF/UTP CAT5e specification.
- Controller and extension rack must be connected directly without a switch between them.



How to connect a ring connection

The controller is connected to the extension rack. The extension rack is connected back to the controller.

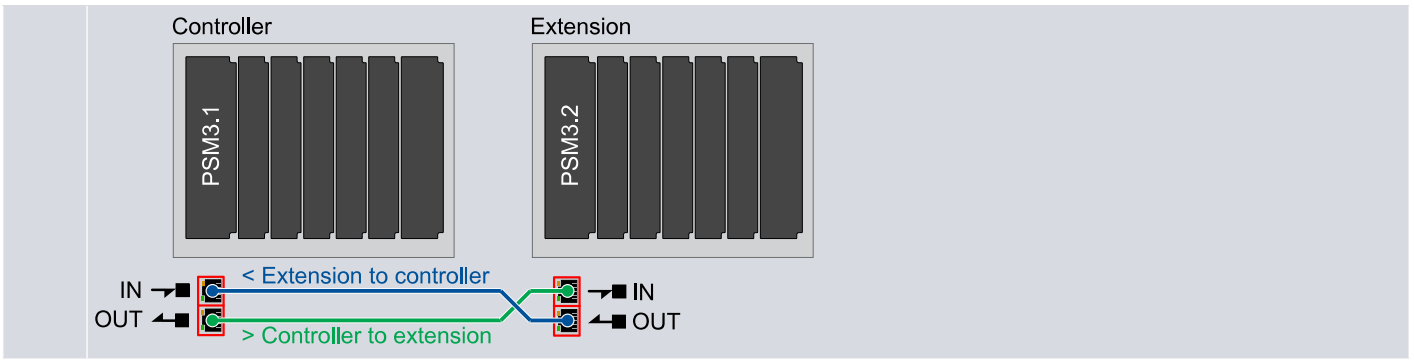

Power off the extension racks before you exchange or re-connect them to another controller.

Cable bend radius

Bends in the Ethernet cables must not be tighter than the minimum bend radius specified by the cable manufacturers. We recommend that you always follow the cable manufacturer's bend radius requirements. It is recommended to use velcro-strips and not cable-ties for the Ethernet cables.

4.3.6 Topology examples

Internal communication must be connected only in a chain or ring configuration. Ring configuration provides redundant communication, should one connection be damaged.

The connection of the extension racks determines the order in which the racks are shown in PICUS and the display.

Chain (single connection)

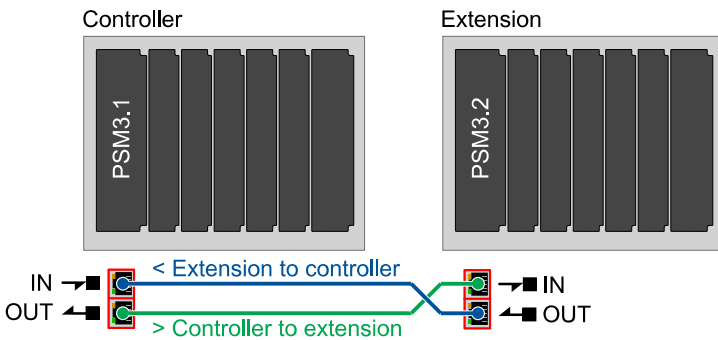



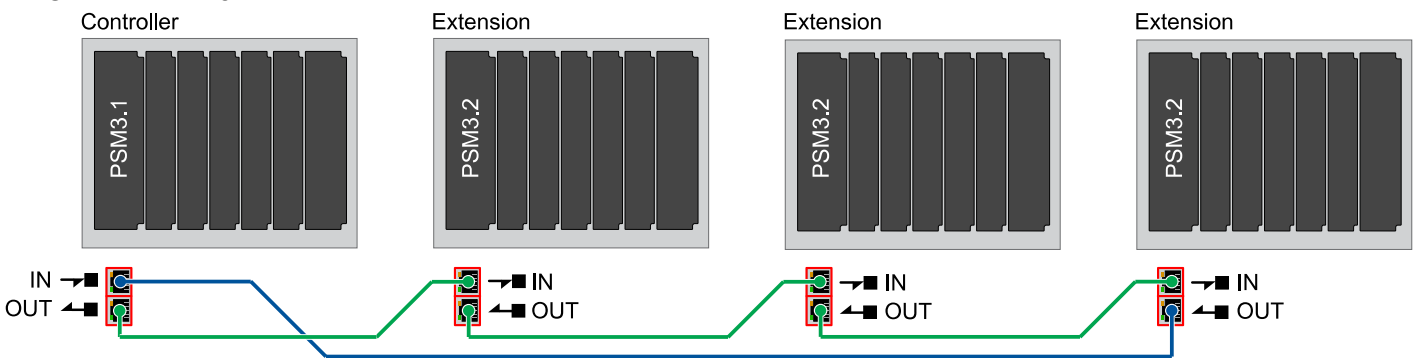





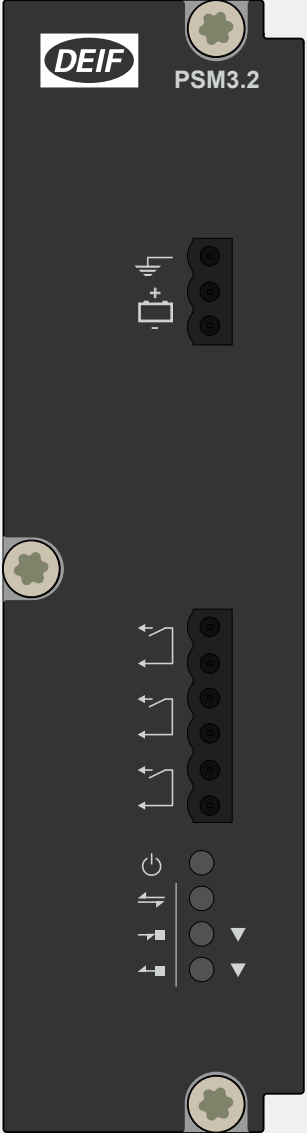



Ring (redundancy connection)



4.4 Power supply module PSM3.2 (Extension rack)

4.4.1 PSM3.2 terminal connections

	Term	Symbol	Name	Type	Default	
	F/G		F/G	Ground	Frame ground	
	1		+	12 or 24 V DC (nominal)	Power supply	
	2		-	0 V DC		
	3		Normally open	Relay output (30 V DC and 1 A)	Configurable	
	4		Common			
	5		Normally open			
	6		Common		Configurable	
	7		Normally open			
	8		Common		Configurable	
	IN		Internal communication input **		RJ45 (bottom of rack, top port)	Input *
	OUT		Internal communication output **		RJ45 (bottom of rack, bottom port)	Output *

NOTE * Default function cannot be changed.

** Internal communication connections are only for communication to extension racks.

4.4.2 Frame ground wiring

Create a protective earth:

1. Connect the frame ground terminal to the protective earth connection.
2. Connect the frame ground terminal to the cabinet.
3. Connect the rack to the cabinet.

The frame ground is connected to the power supply terminals through transient voltage suppression diodes (transorbs). In order to protect the frame ground and power supply, max. 36 V is allowed between the frame ground and the power supply terminals.

4.4.3 Power supply wiring

Connect the power supply (+) to the 12 or 24 V DC power supply, and the power supply (-) to the 0 V DC power supply.

NOTICE

Negative power supply terminal

Do not wire the negative power supply terminal of the modules with independent power supplies (for example, PSM 3.1) to the single-phase ground. If the voltage between the power supply terminals and frame ground exceeds 36 V, the power supply terminals and the frame ground terminal will be damaged.

Recommended wiring for the power supply

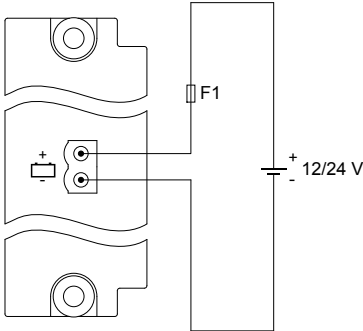

Incorrect wiring of the power supply

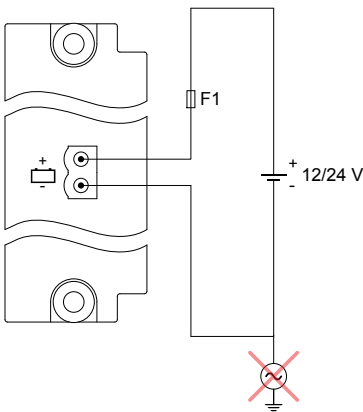

Backup power supply

The equipment does not contain a backup power supply. The power supply source must therefore include the necessary power backup.

Example of a power supply and backup connected to the power supply terminals

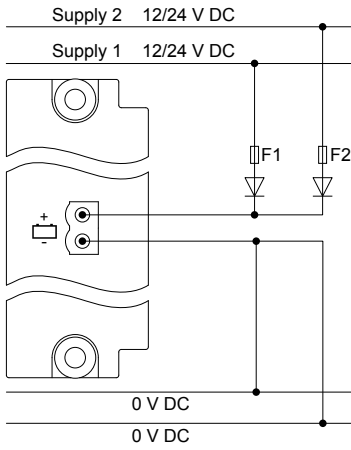

We recommend a 2 A time-delay fuse for 24 V DC and a 4 A time-delay fuse for 12 V DC for F1 and F2, and that the diodes are rated 50V or higher.

NOTICE



Nominal auxiliary voltage is 12 or 24V DC (8 to 36 V DC operating range).

If voltage drops are likely to appear, a 7 A time-delay fuse is needed.

4.4.4 Relay output wiring

The diagram shows the connection of the relay output to an external relay. There is no voltage on the external relay when the controller relay is open.

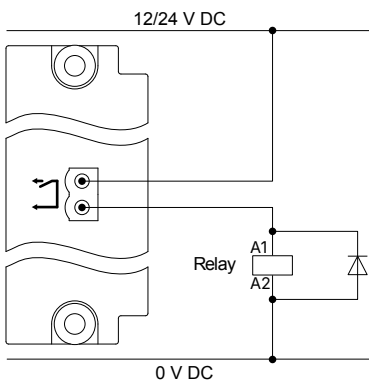

Use a diode size as recommended by the relay supplier.

You can swap the terminal connections around without affecting the performance.

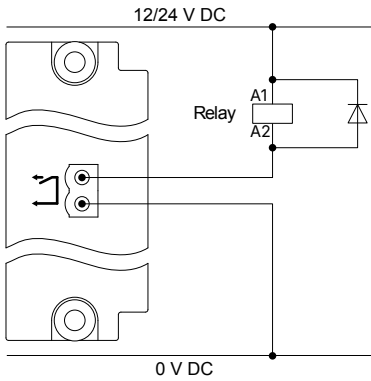



Install a freewheeling diode () to prevent a sudden voltage spike across the inductive load when the voltage source is removed.

4.4.5 PSM3.x EtherCAT connections

Extension racks are connected to controller with the EtherCAT internal communication ports on the PSM3.1 and PSM3.2. These ports are marked in red on the controller and extension rack. Do not use these connections for network communication between controllers, service PCs or switches.

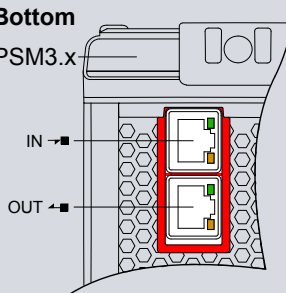
Table 4.3 Location of the EtherCAT communication ports

Symbol	Symbol	Port location	Notes
Bottom PSM3.x 	IN 	Bottom of rack, top port	Internal communication: IN port from other rack
	OUT 	Bottom of rack, bottom port	Internal communication: OUT port to other rack

EtherCAT communication restrictions

The racks have an OUT port and an IN port for internal communication. The OUT port must always be connected to an IN port on the next extension rack.

- With 1 extension rack, you can optionally create a ring network by connecting the last extension rack back to the controller.
- With 2 or more extension racks, you must create a ring network by connecting the last extension rack back to the controller.
- Up to 5 extension racks can be connected to the same controller.
- The cables must not be longer than 100 metres from point-to-point.
- The cables must meet or exceed the SF/UTP CAT5e specification.
- Controller and extension rack must be connected directly without a switch between them.



How to connect a ring connection

The controller is connected to the extension rack. The extension rack is connected back to the controller.

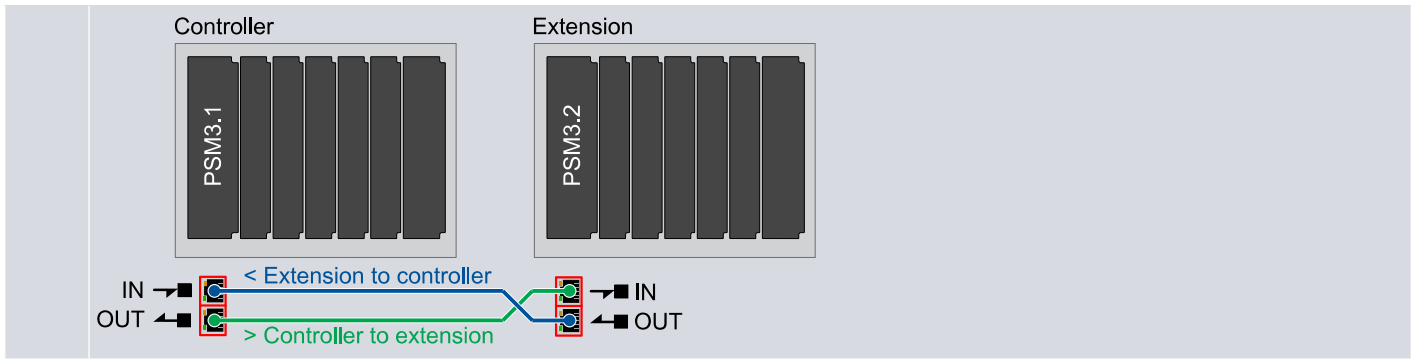

Power off the extension racks before you exchange or re-connect them to another controller.

Cable bend radius

Bends in the Ethernet cables must not be tighter than the minimum bend radius specified by the cable manufacturers. We recommend that you always follow the cable manufacturer's bend radius requirements. It is recommended to use velcro-strips and not cable-ties for the Ethernet cables.

4.4.6 Topology examples

Internal communication must be connected only in a chain or ring configuration. Ring configuration provides redundant communication, should one connection be damaged.

The connection of the extension racks determines the order in which the racks are shown in PICUS and the display.

Chain (single connection)

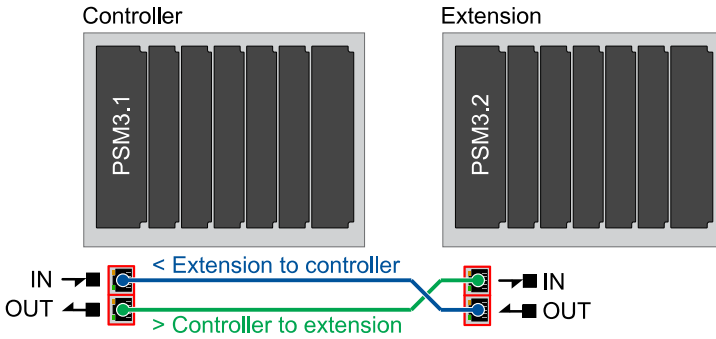

Ring (redundancy connection)

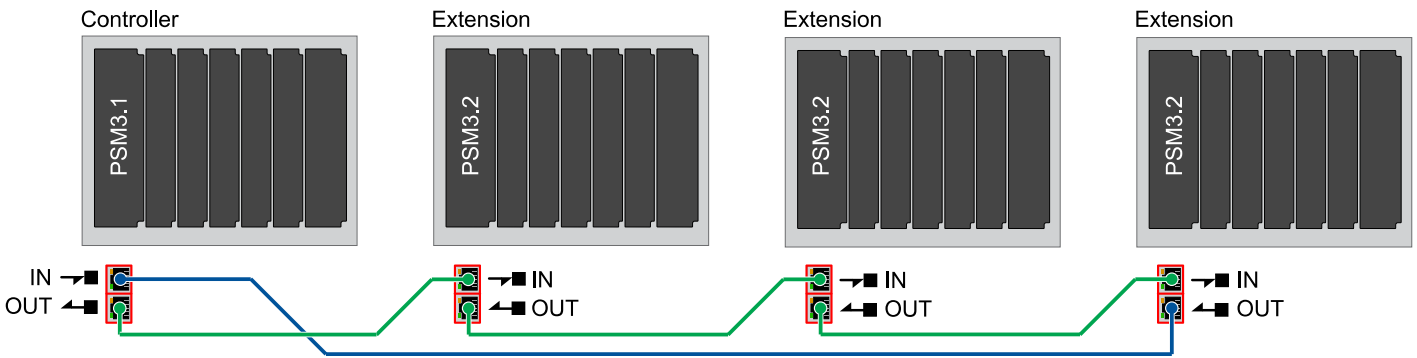

4.5 Alternating current module ACM3.1

4.5.1 ACM3.1 terminal connections

Controller specific function names

Function	SINGLE	GENSET	EMERGENCY	MAINS	HYBRID	SHAFT	SHORE	BTB
A-side	Generator	Generator	Generator	Mains	Inverter	Generator	Shore busbar	Busbar A
B-side	Mains	Busbar	Busbar	Busbar	Busbar	Busbar	Ship busbar	Busbar B

	Term	Symbol	Name	Type	Default	
	1	L1	L1 voltage	Voltage ** 100 to 690 V AC phase-to-phase (nominal)	B-side L1	
	2	L2	L2 voltage		B-side L2	
	3	L3	L3 voltage		B-side L3	
	4	N	N voltage		Optional *	
	5	L1	L1 voltage	Voltage ** 100 to 690 V AC phase-to-phase (nominal)	A-side L1	
	6	L2	L2 voltage		A-side L2	
	7	L3	L3 voltage		A-side L3	
	8	N	N voltage		Optional	
	9			Current in (Europe: S1; US: ·)	Current *** 1 or 5 A AC (nominal)	A-side L1
	10					
	11			Current in (Europe: S1; US: ·)	Current *** 1 or 5 A AC (nominal)	A-side L2
	12					
	13			Current in (Europe: S1; US: ·)	Current *** 1 or 5 A AC (nominal)	A-side L3
	14					
	15			Current in (Europe: S1; US: ·)	Current *** 1 or 5 A AC (nominal)	Configurable
	16					

NOTE * The Neutral terminal must only be wired if it is available on both the B-side and the A-side. If neutral is wired on just one side it could cause an error during synchronisation.

** The two sets of voltage measurements must not be swapped around. The controller uses the A-side of voltage measurements together with the L1 to L3 current measurements for a number of calculations. We recommend to fit encoding pins to the voltage measurement terminals.

*** When iE 350 Marine is used as a safety system, the secondary side of the current transformer must have a nominal rating of 1 A and set to 1 A in the controller parameters. A current transformer with a 5 A nominal rating on the secondary side can be used in other applications.



DANGER!



Do not connect or disconnect a CT with live current present

The current measurement terminal block must always be screwed onto the module.

Do not connect or disconnect any current transformer (CT) while there is current in the line.

4.5.2 Voltage encoding pins for ACM3.1

We strongly recommend the use of encoding pins on the voltage terminals of the ACM3.1.

Mount encoding pins

For safety reasons the encoding pins should not be reused. Once they are installed it is difficult to remove the pins without damaging the equipment.

1. Identify the terminals where you want to place the encoding pins.
 - a. For example, terminal 1 in terminal group 1-2-3-4 and terminal 5 in terminal group 5-6-7-8 on the ACM3.1 module.
2. Remove the terminal blocks from the module.
3. Place the J-shaped encoding pin in one of the slots next to a terminal pin on the module. The encoding pin is secured when you hear it click into position.
4. Slide the flat encoding pin into the groove on the terminal block of the second terminal group that matches the position of the encoding pin placed in step 3.



Example fitting voltage encoding pins to ACM3.1

The current measurement terminal block must always be screwed onto the module. If for some reason the terminal block is unscrewed, secure it using a 0.25 N·m (2.2 lb-in) torque screwdriver with a 3.5 mm (0.14 in) flat-bladed bit.

4.5.5 Power transformer

For **GENSET** or **HYBRID** controllers, you can optionally use either a step-up or step-down Power transformer connected to the ACM3.1. Configure the Phase shift, and the winding nominal voltages.

For **GENSET** or **SINGLE genset** controllers, you can optionally use either a step-up or step-down Power transformer connected to the ACM3.1. Configure the Phase shift, and the winding nominal voltages.



More information

See **Designer's handbook** for how to configure the Power transformer settings.

4.6 Differential current module ACM3.2

4.6.1 ACM3.2 terminal connections

	Term	Symbol	Name	Type	Default
	1	s_1^*	Current in (Europe: S1; US: ·)	Current * 1 or 5 A AC (nominal)	Consumer side L1
	2	s_2	Current out (Europe: S2)		
	3	s_1^*	Current in (Europe: S1; US: ·)	Current * 1 or 5 A AC (nominal)	Consumer side L2
	4	s_2	Current out (Europe: S2)		
	5	s_1^*	Current in (Europe: S1; US: ·)	Current * 1 or 5 A AC (nominal)	Consumer side L3
	6	s_2	Current out (Europe: S2)		
	7	s_1^*	Current in (Europe: S1; US: ·)	Current * 1 or 5 A AC (nominal)	Neutral side L1
	8	s_2	Current out (Europe: S2)		
	9	s_1^*	Current in (Europe: S1; US: ·)	Current * 1 or 5 A AC (nominal)	Neutral side L2
	10	s_2	Current out (Europe: S2)		
	11	s_1^*	Current in (Europe: S1; US: ·)	Current * 1 or 5 A AC (nominal)	Neutral side L3
	12	s_2	Current out (Europe: S2)		

NOTE * The two sets of current measurements must not be swapped around.



More information

See **AC configuration and nominal settings** in the **Designer's handbook** for how to change the reference direction of the current transformer.



DANGER!

Do not connect or disconnect a CT with live current present



If a CT is disconnected when there is current in the line, a high voltage is generated across the secondary of the CT. This can cause arcing, personal injury or death, or damage to the controller.

The current measurement terminal block must always be screwed onto the module. Do not connect or disconnect any current transformer (CT) while there is current in the line.

4.6.2 Current encoding pins for ACM3.2

We strongly recommend the use of encoding pins on the current terminals of the ACM3.2.



Example fitting voltage encoding pins to ACM3.2

The encoding pins for the ACM3.2 are not the same as the encoding pins for voltage on the ACM3.1 or other terminals.

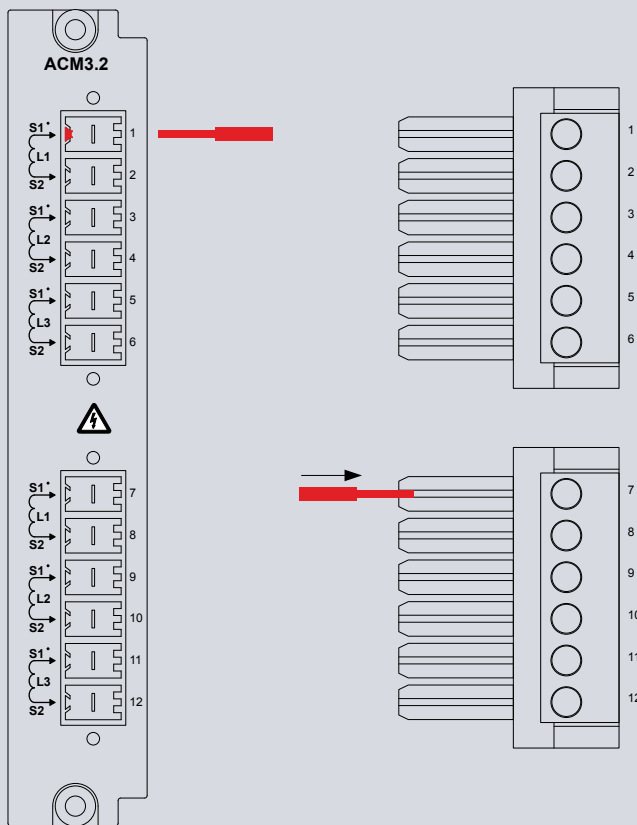

4.6.3 Current measurements wiring

By default the direction of the current transformers are towards the protected area (as shown in the default wiring). If the direction of the current transformers is not the same as the default direction, then the *Current reference dir.* parameter must be update to be the same as the direction of the installed current transformer.

The current inputs are galvanically separated.

Mount each current transformer and connect it to the controller terminals so that each measurement current flows through the controller in the correct direction. Incorrect mounting and wiring causes faulty current measurements (see the controller wiring diagrams for the correct mounting direction and wiring).



DANGER!

Do not connect or disconnect a CT with live current present



If a CT is disconnected when there is current in the line, a high voltage is generated across the secondary of the CT. This can cause arcing, personal injury or death, or damage to the controller.

The current measurement terminal block must always be screwed onto the module. Do not connect or disconnect any current transformer (CT) while there is current in the line.

The current measurement terminal block must always be screwed onto the module. If for some reason the terminal block is unscrewed, secure it using a 0.25 N·m (2.2 lb-in) torque screwdriver with a 3.5 mm (0.14 in) flat-bladed bit.

4.7 Input/output module IOM3.1

4.7.1 IOM3.1 terminal connections

	Term	Symbol	Name	Type	Default
	1		Normally open	Relay output (250 V AC or 30 V DC, and 6 A)	Configurable
	2		Common		
	3		Normally closed		
	4		Normally open	Relay output (250 V AC or 30 V DC, and 6 A)	Configurable
	5		Common		
	6		Normally closed		
	7		Normally open	Relay output (250 V AC or 30 V DC, and 6 A)	Configurable
	8		Common		
	9		Normally closed		
	10		Normally open	Relay output (250 V AC or 30 V DC, and 6 A)	Configurable
	11		Common		
	12		Normally closed		
	13		Bi-directional input	Digital input (OFF: 0 to 2 V DC, ON: 8 to 36 V DC, Impedance: 4.7 kΩ)	Configurable
	14		Bi-directional input	Digital input (OFF: 0 to 2 V DC, ON: 8 to 36 V DC, Impedance: 4.7 kΩ)	Configurable
	15		Bi-directional input	Digital input (OFF: 0 to 2 V DC, ON: 8 to 36 V DC, Impedance: 4.7 kΩ)	Configurable
	16		Bi-directional input	Digital input (OFF: 0 to 2 V DC, ON: 8 to 36 V DC, Impedance: 4.7 kΩ)	Configurable
	17		Bi-directional input	Digital input (OFF: 0 to 2 V DC, ON: 8 to 36 V DC, Impedance: 4.7 kΩ)	Configurable
	18		Bi-directional input	Digital input (OFF: 0 to 2 V DC, ON: 8 to 36 V DC, Impedance: 4.7 kΩ)	Configurable
	19		Bi-directional input	Digital input (OFF: 0 to 2 V DC, ON: 8 to 36 V DC, Impedance: 4.7 kΩ)	Configurable
	20		Bi-directional input	Digital input (OFF: 0 to 2 V DC, ON: 8 to 36 V DC, Impedance: 4.7 kΩ)	Configurable
	21		Bi-directional input	Digital input (OFF: 0 to 2 V DC, ON: 8 to 36 V DC, Impedance: 4.7 kΩ)	Configurable
	22		Bi-directional input	Digital input (OFF: 0 to 2 V DC, ON: 8 to 36 V DC, Impedance: 4.7 kΩ)	Configurable
	23	COM	Common	Digital input	

4.7.2 Relay output wiring (changeover)

This changeover relay has three terminals: normally closed, common and normally open. You can connect wiring to:

- All three terminals
- Common and normally open terminals
- Common and normally closed terminals

Connection to Normally open and common terminals

Relay output connected to a 230 V AC contactor. You can swap the terminal connections around without affecting the performance.

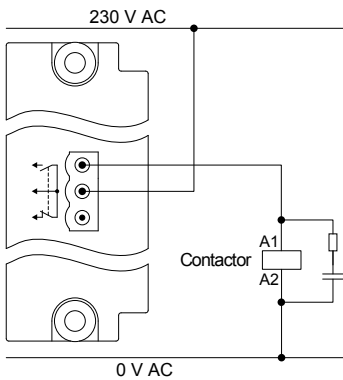

Similarly, you can connect equipment to the normally closed terminal and common.

Connection to all three terminals

For this configuration, current flows through the equipment connected to the normally closed terminal when the relay is de-energised. The current flows through the equipment connected to the normally open terminal when the relay is energised.

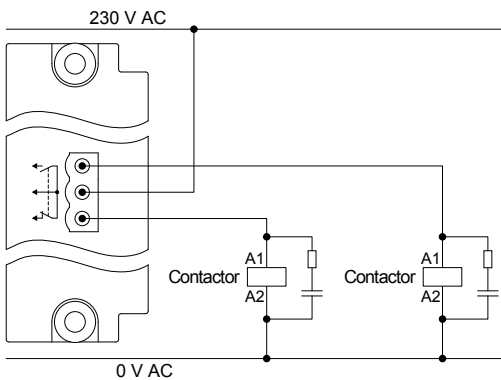

For 230 V AC contactors, we strongly recommend that you use an RC snubber for noise suppression across the contactor.

4.7.3 Digital input wiring

The digital inputs are bi-directional, so you can swap the terminal connections around without affecting the performance..

However, all the digital inputs in a group share a common terminal. The digital input common for a module may be either low (connected to 0 V), or high (connected to 12 or 24 V):

- If common is low: All the digital input signals connected to the group must be high (connected to 12 or 24 V).
- If common is high: All the digital input signals connected to the group must be low (connected to 0 V).

The digital input common is not used as the common for any of the other terminals on the same hardware module. The digital input common is also not affected by the digital input commons on other hardware modules.

Digital input wiring (common = 0 V)

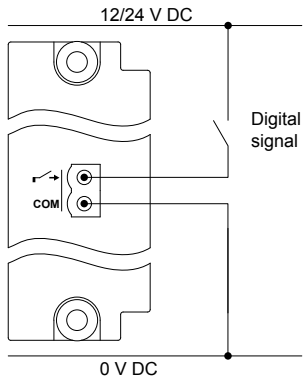

Digital input wiring (common = 12 or 24 V)

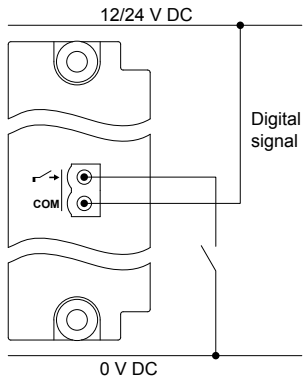

Safety function wiring

Safety functions, for example, *Emergency stop*, require a normally closed digital signal to be wired to the controller.

Digital input wiring for safety functions (common = 0 V)

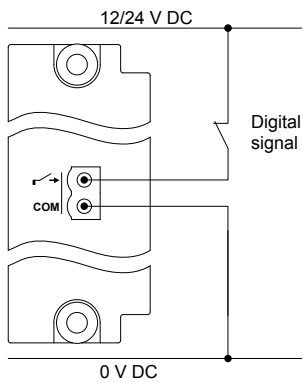

Digital input wiring for safety functions (common = 12 or 24 V)

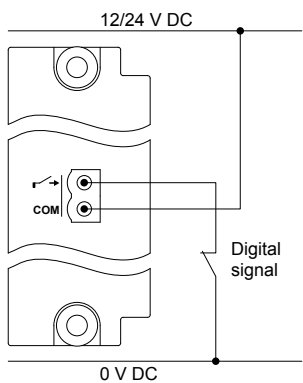

Compliance with EN60255-26

If the wire to an open contact is over 10 m long, then additional measures are required for compliance with EN60255-26. You can use a 1 k Ω resistor to common, or you can use a twisted or shielded wire to the open contact.

1 k Ω resistor to common for compliance with EN60255-26

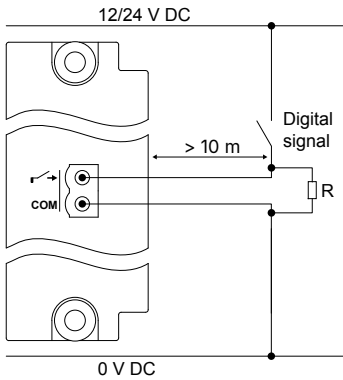

Twisted wire for compliance with EN60255-26

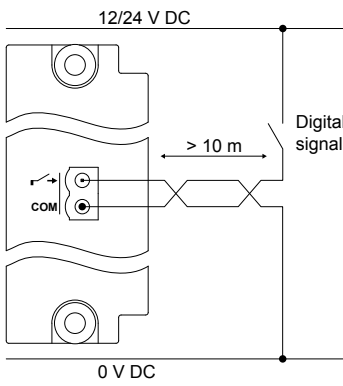

Shielded wire for compliance with EN60255-26

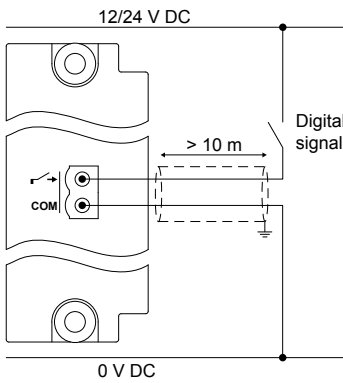

Closed contact for compliance with EN60255-26

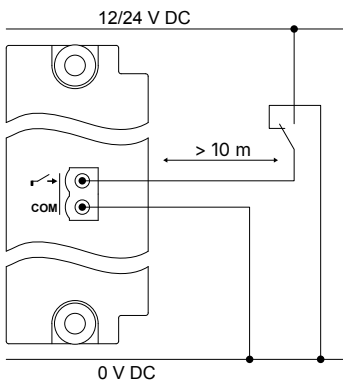

4.8 Input/output module IOM3.2

4.8.1 IOM3.2 terminal connections

IOM3.2 terminals 1 to 16

	Term	Symbol	Name	Type	Default
	1		Normally open	Relay output (30 V DC and 6 A)	Configurable
	2		Common		
	3		Normally open	Relay output (30 V DC and 6 A)	Configurable
	4		Common		
	5		Normally open	Relay output (30 V DC and 6 A)	Configurable
	6		Common		
	7		Normally open	Relay output (30 V DC and 6 A)	Configurable
	8		Common		
	9		Analogue output	Analogue current output (-25 to 25 mA DC) Analogue voltage output (-10 to 10 V DC) Analogue PWM output (1 to 2500 Hz)	Configurable
	10		Common		
	11		Analogue output		
	12		Common	Analogue current output (-25 to 25 mA DC) Analogue voltage output (-10 to 10 V DC) Analogue PWM output (1 to 2500 Hz)	Configurable
	13		Analogue output		
	14		Common		
	15		Analogue output	Analogue current output (-25 to 25 mA DC) Analogue voltage output (-10 to 10 V DC)	Configurable
	16		Common		
17					
18					
19					
20					
21					
22					
23					
24					
25					
26					
27					
28					
29					

IOM3.2 terminals 17 to 29

	Term	Symbol	Name	Type	Default
	17		Bi-directional input	Digital input (OFF: -2 to 2 V DC, ON: -36 to -8 V DC or 8 to 36 V DC, Impedance: 3.9 kΩ)	Configurable
	18		Bi-directional input	Digital input (OFF: -2 to 2 V DC, ON: -36 to -8 V DC or 8 to 36 V DC, Impedance: 3.9 kΩ)	Configurable
	19		Bi-directional input	Digital input (OFF: -2 to 2 V DC, ON: -36 to -8 V DC or 8 to 36 V DC, Impedance: 3.9 kΩ)	Configurable
	20		Bi-directional input	Digital input (OFF: -2 to 2 V DC, ON: -36 to -8 V DC or 8 to 36 V DC, Impedance: 3.9 kΩ)	Configurable
	21	COM	Common		-
	22		Analogue input	Current input (0 to 20 mA or 4 to 20 mA) Voltage input (-10 to 10 V DC or 0 to 10 V DC) RMI 1 or 2 wire (0 to 4.5 kΩ) Pt100 (-200 to 850 °C) Pt1000 (-200 to 850 °C)	Configurable
	23		Common	Thermocouple (E: -200 to 1000 °C, J: -210 to 1200 °C, K: -200 to 1372 °C, N: -200 to 1300 °C, R: -50 to 1768 °C, S: -50 to 1768 °C, T: -200 to 400 °C)	
	24		Analogue input	Current input (0 to 20 mA or 4 to 20 mA) Voltage input (-10 to 10 V DC or 0 to 10 V DC) RMI 1 or 2 wire (0 to 4.5 kΩ) Pt100 (-200 to 850 °C) Pt1000 (-200 to 850 °C)	Configurable
	25		Common	Thermocouple (E: -200 to 1000 °C, J: -210 to 1200 °C, K: -200 to 1372 °C, N: -200 to 1300 °C, R: -50 to 1768 °C, S: -50 to 1768 °C, T: -200 to 400 °C)	
	26		Analogue input	Current input (0 to 20 mA or 4 to 20 mA) Voltage input (-10 to 10 V DC or 0 to 10 V DC) RMI 1 or 2 wire (0 to 4.5 kΩ) Pt100 (-200 to 850 °C) Pt1000 (-200 to 850 °C)	Configurable
	27		Common	Thermocouple (E: -200 to 1000 °C, J: -210 to 1200 °C, K: -200 to 1372 °C, N: -200 to 1300 °C, R: -50 to 1768 °C, S: -50 to 1768 °C, T: -200 to 400 °C)	
	28		Analogue input	Current input (0 to 20 mA or 4 to 20 mA) Voltage input (-10 to 10 V DC or 0 to 10 V DC) RMI 1 or 2 wire (0 to 4.5 kΩ) Pt100 (-200 to 850 °C) Pt1000 (-200 to 850 °C)	Configurable
29		Common	Thermocouple (E: -200 to 1000 °C, J: -210 to 1200 °C, K: -200 to 1372 °C, N: -200 to 1300 °C, R: -50 to 1768 °C, S: -50 to 1768 °C, T: -200 to 400 °C)		

4.8.2 Relay output wiring

The diagram shows the connection of the relay output to an external relay. There is no voltage on the external relay when the controller relay is open.

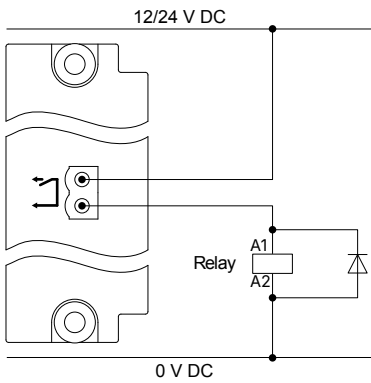

Use a diode size as recommended by the relay supplier.

You can swap the terminal connections around without affecting the performance.

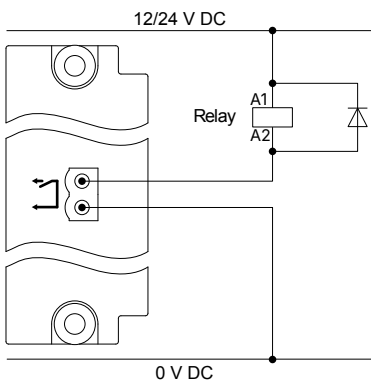

Install a freewheeling diode () to prevent a sudden voltage spike across the inductive load when the voltage source is removed.

4.8.3 Pulse width modulation (PWM) output wiring (terminals 9-10 or 11-12 only)

Pulse width modulation (PWM) output is normally used to control a governor. The PWM could also be used as an input for another controller, as shown in the diagram below. PWM wiring can only be made to terminals 9 and 10, or 11 and 12.

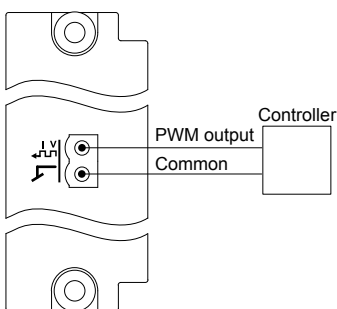

4.8.4 Analogue multifunctional current or voltage outputs wiring

The diagram below shows the connection of an external controller to the DEIF controller's analogue current or voltage output. The I/O configuration determines whether the output is current or voltage.

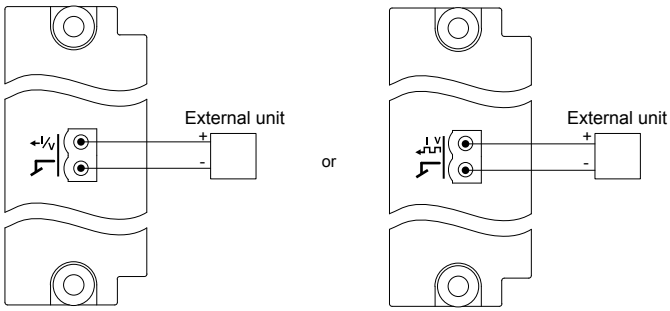

NOTICE

Terminal damage

These outputs are active outputs. Do not connect an external power supply to these terminals. Connecting an external power supply may damage the terminals.

Using an analogue output with an external instrument

The analogue output can be connected directly to a 4 to 20 mA external instrument:

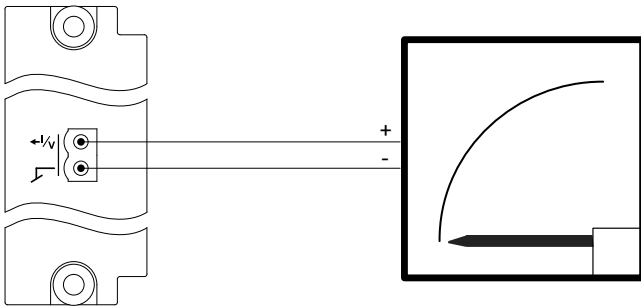

DEIF recommends using instruments from the DEIF DQ moving coil instrument series. See <http://www.deif.com> for more information.

4.8.5 Digital input wiring

The digital inputs are bi-directional, so you can swap the terminal connections around without affecting the performance..

However, all the digital inputs in a group share a common terminal. The digital input common for a module may be either low (connected to 0 V), or high (connected to 12 or 24 V):

- If common is low: All the digital input signals connected to the group must be high (connected to 12 or 24 V).
- If common is high: All the digital input signals connected to the group must be low (connected to 0 V).

The digital input common is not used as the common for any of the other terminals on the same hardware module. The digital input common is also not affected by the digital input commons on other hardware modules.

Digital input wiring (common = 0 V)

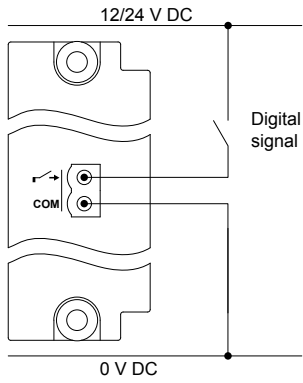

Digital input wiring (common = 12 or 24 V)

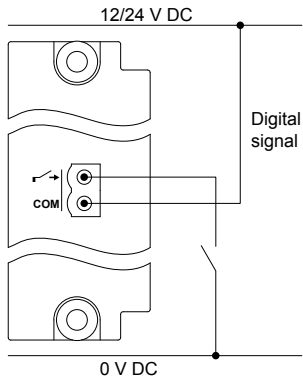

Safety function wiring

Safety functions, for example, *Emergency stop*, require a normally closed digital signal to be wired to the controller.

Digital input wiring for safety functions (common = 0 V)

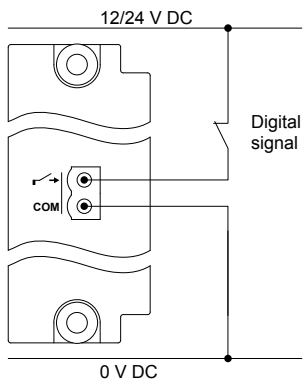

Digital input wiring for safety functions (common = 12 or 24 V)

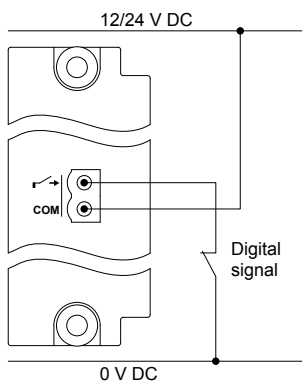

Compliance with EN60255-26

If the wire to an open contact is over 10 m long, then additional measures are required for compliance with EN60255-26. You can use a 1 k Ω resistor to common, or you can use a twisted or shielded wire to the open contact.

1 k Ω resistor to common for compliance with EN60255-26

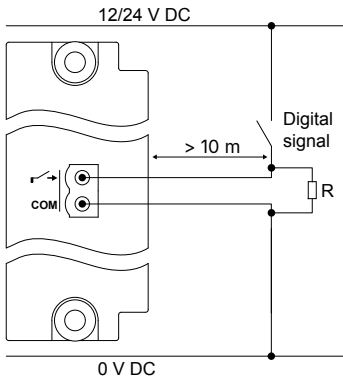

Twisted wire for compliance with EN60255-26

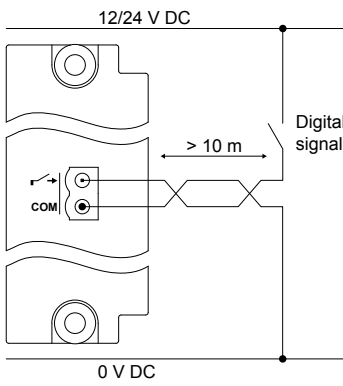

Shielded wire for compliance with EN60255-26

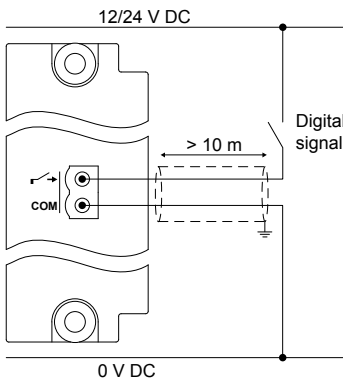

Closed contact for compliance with EN60255-26

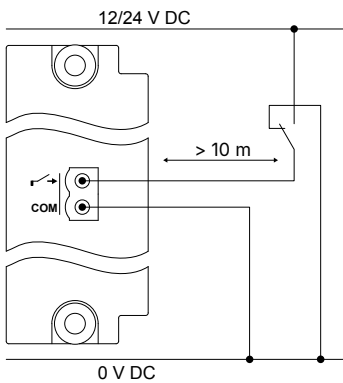

4.8.6 Analogue multifunctional inputs wiring

The I/O configuration determines whether the input is current or resistance. For resistance, the I/O configuration also determines the type of resistance input.

NOTICE

Before connecting external transmitter

Configure the terminals correctly (that is, for current or for voltage) before connecting the external transmitter.

Digital inputs with wire break detection

Wire-break detection with maximum resistance for ON detection: 100 Ω to 400 Ω .

Connection of a dry contact with cable supervision

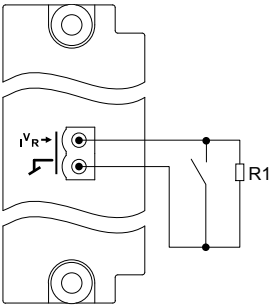

Requirements:

- The maximum resistance for the circuit and resistor (R1) is 330 Ω .
- R1 must be connected to the switch, and not to the controller terminals.

Connection of a dry contact with cable supervision, and short circuit detection

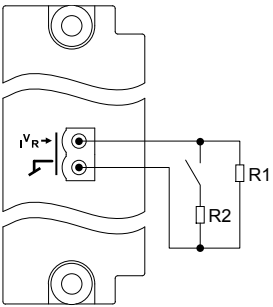

Requirements:

- The maximum resistance for the circuit and resistor (R1) is 330 Ω .
- The resistance of R2 must be less than R1.
- R1 must be connected to the switch, and not to the controller terminals.

Current input

The current input may be either active or passive, and a combination of active and passive inputs may be used.

Connection of an active transducer

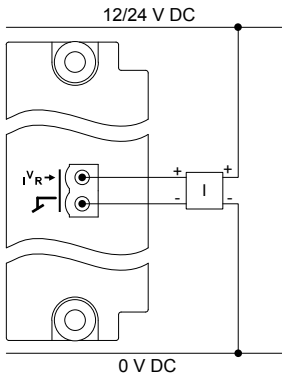

Connection of a passive transducer

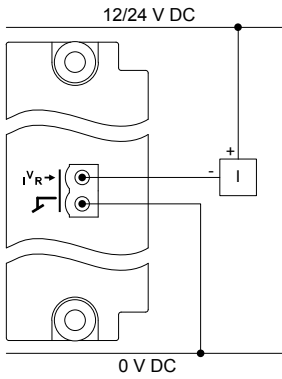

Voltage input

The following diagram shows the connection for voltage input.

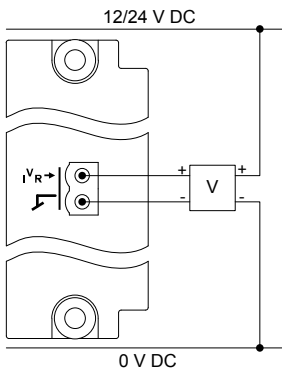

Resistance input

The resistance inputs are always passive inputs. The controller sends a small current through the external equipment and measures the resistance.

NOTE There is no software compensation for the wire length to the resistance input.

Connection of a 2-wire Pt100/1000 sensor

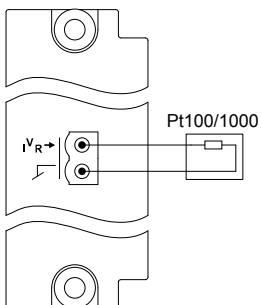

Connection of a 3-wire Pt100/1000 sensor

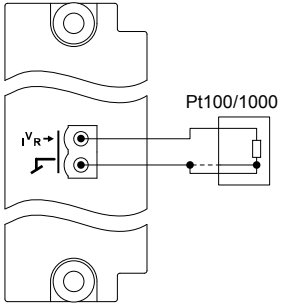

You do not have to connect the third wire (shown by the dashed line). If you want to connect the third wire, connect it to the common, as shown in the diagram.

Connection of a 4-wire Pt100/1000 sensor

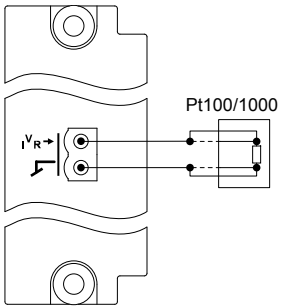

You do not have to connect the third and fourth wires (shown by the dashed lines). If you want to connect them, connect them as shown in the diagram.

Connection of a 1-wire resistance measurement input (RMI)

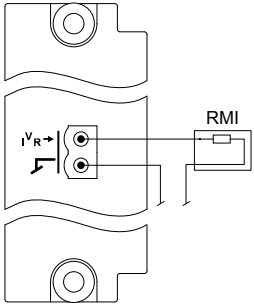

Connection of a 2-wire resistance measurement input (RMI)

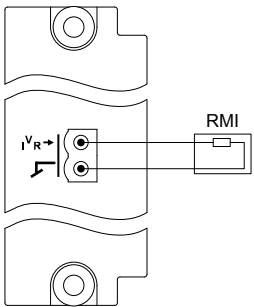

4.9 Input/output module IOM3.3

4.9.1 IOM3.3 terminal connections

Table 4.4 IOM3.3 Analogue multifunctional inputs

	Term	Symbol	Name	Type	Default
	1	A	Analogue input	Current input 0 to 20 mA or 4 to 20 mA	Configurable
	2	→ B			
	3	C			
	4	A	Analogue input	Voltage input -10 to 10 V DC or 0 to 10 V DC	Configurable
	5	→ B			
	6	C			
	7	A	Analogue input	RMI 2 or 3 wire 0 to 4.5 kΩ ±1 Ω	Configurable
	8	→ B			
	9	C			
	10	A	Analogue input	RMI 1 wire 0 to 4.5 kΩ ±2 Ω	Configurable
	11	→ B			
	12	C			
	13	A	Analogue input	Pt100 -200 to 850 °C	Configurable
	14	→ B			
	15	C			
	16	A	Analogue input	Pt1000 -200 to 850 °C	Configurable
	17	→ B			
	18	C			
	19	A	Analogue input	Thermocouple E: -200 to 1000 °C J: -210 to 1200 °C K: -200 to 1372 °C N: -200 to 1300 °C R: -50 to 1768 °C S: -50 to 1768 °C T: -200 to 400 °C	Configurable
	20	→ B			
	21	C			
	22	A	Analogue input		Configurable
	23	→ B			
	24	C			
	25	A	Analogue input		Configurable
	26	→ B			
	27	C			
	28	A	Analogue input		Configurable
	29	→ B			
	30	C			

4.9.2 Analogue multifunctional inputs

The I/O configuration determines whether the input is current or resistance. For resistance, the I/O configuration also determines the type of resistance input.

NOTICE

Before connecting the external transmitter

Configure the terminals correctly (that is, for current or for voltage) before connecting the external transmitter.

4.9.3 Digital inputs wiring with wire break detection

Wire-break detection with maximum resistance for ON detection: 100 Ω to 400 Ω .

Figure 4.1 Connection of a dry contact with cable supervision

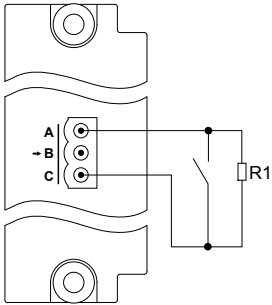

Requirements:

- The maximum resistance for the circuit and resistor (R1) is 330 Ω .
- R1 must be connected to the switch, and not to the controller terminals.

Figure 4.2 Connection of a dry contact with cable supervision, and short circuit detection

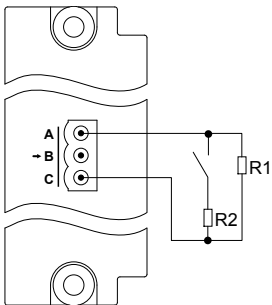

Requirements:

- The maximum resistance for the circuit and resistor (R1) is 330 Ω .
- The resistance of R2 must be less than R1.
- R1 must be connected to the switch, and not to the controller terminals.

4.9.4 Analogue current inputs wiring

The current input may be either active or passive, and a combination of active and passive inputs may be used.

Figure 4.3 Connection of an active transducer

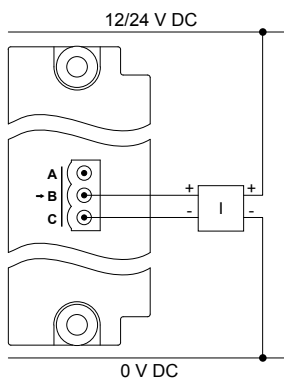
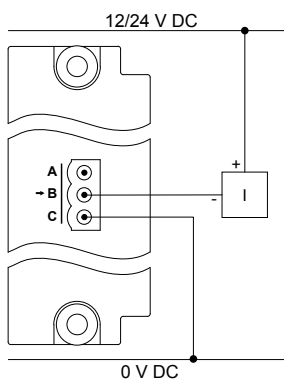
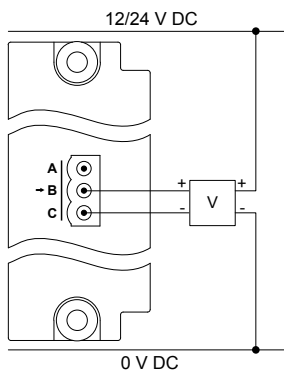

Figure 4.4 Connection of a passive transducer



4.9.5 Analogue voltage inputs wiring

The following diagram shows the connection for voltage input.



4.9.6 Analogue resistance inputs wiring

The resistance inputs are always passive inputs. The controller sends a small current through the external equipment and measures the resistance.

NOTE There is no software compensation for the wire length to the resistance input.

Figure 4.5 Connection of a 2-wire Pt100/1000 sensor

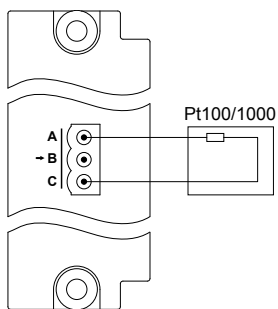

Figure 4.6 Connection of a 3-wire Pt100/1000 sensor

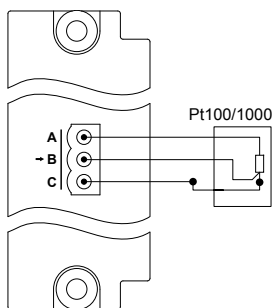
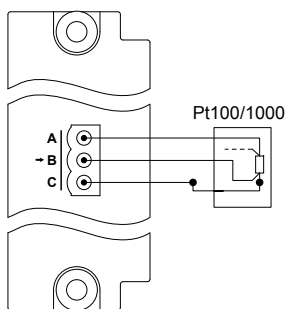

Figure 4.7 Connection of a 4-wire Pt100/1000 sensor



You do not have to connect the fourth wire (shown by the dashed line).

Figure 4.8 Connection of a 1-wire resistance measurement input (RMI)

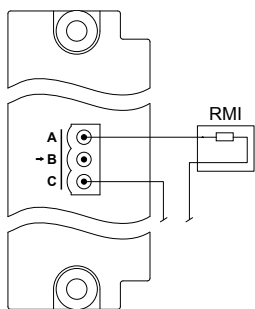

Figure 4.9 Connection of a 2-wire resistance measurement input (RMI)

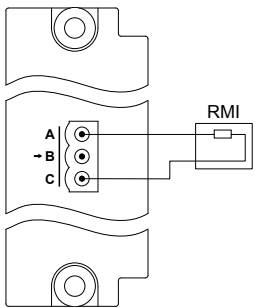
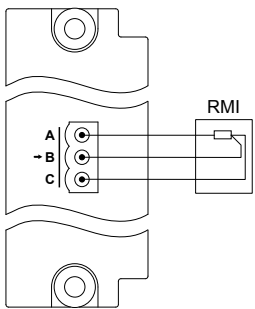
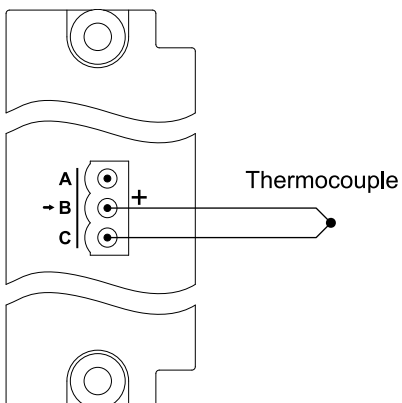

Figure 4.10 Connection of a 3-wire resistance measurement input (RMI)



4.9.7 Analogue thermocouple inputs wiring

Figure 4.11 Connection of thermocouple with internal compensation input



Compensation occurs in the IOM3.3 module.

Figure 4.12 Connection of thermocouple with external compensation input

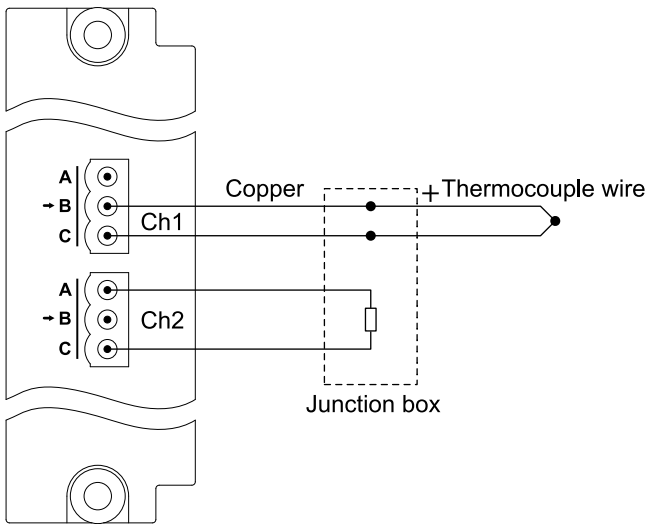

The cold junction compensation can be wired to any input on the controller that can measure a temperature sensor.

4.10 Input/output module IOM3.4

4.10.1 IOM3.4 terminal connections

	Term.	Symbol	Name	Type	Default
<p>IOM3.4</p> <p>1 2 3 4 5 6 7 8 9 10 11 12 13 14</p> <p>15 16 17 18 19 20 21 22</p> <p>COM 23</p> <p>24 25 26 27 28 29 30 31</p> <p>COM 32</p>	1		Positive supply	Positive supply for digital output terminals 2 to 13 (12 or 24 V DC) (nominal), maximum 36 V DC	Positive supply
	2		Digital output	Digital outputs: Maximum current: < 55 °C: 250 mA (per output) Leak current: Typical 1 µA, maximum 100 µA Saturation voltage: Maximum 0.5 V Non-replaceable: 4 A fuse Voltage withstand: ±36 V DC	Configurable
	3		Digital output		Configurable
	4		Digital output		Configurable
	5		Digital output		Configurable
	6		Digital output		Configurable
	7		Digital output		Configurable
	8		Digital output		Configurable
	9		Digital output		Configurable
	10		Digital output		Configurable
	11		Digital output		Configurable
	12		Digital output		Configurable
	13		Digital output		Configurable
	14		Common		Common for digital output terminals 2 to 13
	15		Bi-directional input	Digital inputs: OFF: 0 to 2 V DC ON: 8 to 36 V DC Impedance: 4.7 kΩ	Configurable
	16		Bi-directional input		Configurable
	17		Bi-directional input		Configurable
	18		Bi-directional input		Configurable
	19		Bi-directional input		Configurable
	20		Bi-directional input		Configurable
	21		Bi-directional input		Configurable
	22		Bi-directional input		Configurable
	23	COM	Common	Common for digital input terminals 15 to 22	

	Term.	Symbol	Name	Type	Default
	24		Bi-directional input	Digital inputs: OFF: 0 to 2 V DC ON: 8 to 36 V DC Impedance: 4.7 kΩ	Configurable
	25		Bi-directional input		Configurable
	26		Bi-directional input		Configurable
	27		Bi-directional input		Configurable
	28		Bi-directional input		Configurable
	29		Bi-directional input		Configurable
	30		Bi-directional input		Configurable
	31		Bi-directional input		Configurable
	32	COM	Common		Common for digital input terminals 24 to 31

4.10.2 Digital output wiring

Each transistor has a normally open terminal (). The transistor group has a positive supply terminal (+), and a common (-). The following diagram shows the connection of the transistor output to an external contactor.

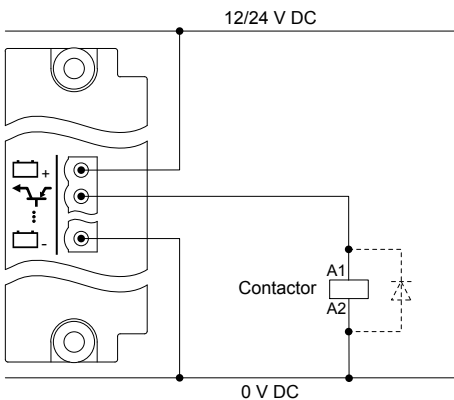

NOTE You can install a diode () to reduce electromagnetic interference.

4.10.3 Digital input wiring

The digital inputs are bi-directional, so you can swap the terminal connections around without affecting the performance..

However, all the digital inputs in a group share a common terminal. The digital input common for a module may be either low (connected to 0 V), or high (connected to 12 or 24 V):

- If common is low: All the digital input signals connected to the group must be high (connected to 12 or 24 V).
- If common is high: All the digital input signals connected to the group must be low (connected to 0 V).

The digital input common is not used as the common for any of the other terminals on the same hardware module. The digital input common is also not affected by the digital input commons on other hardware modules.

Digital input wiring (common = 0 V)

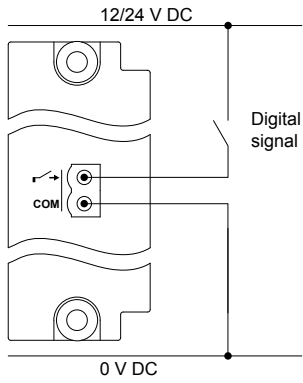

Digital input wiring (common = 12 or 24 V)

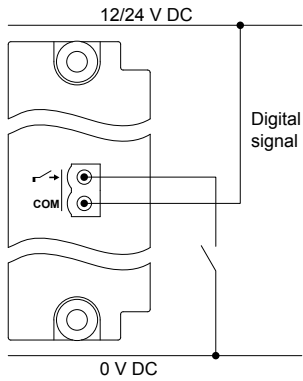

Safety function wiring

Safety functions, for example, *Emergency stop*, require a normally closed digital signal to be wired to the controller.

Digital input wiring for safety functions (common = 0 V)

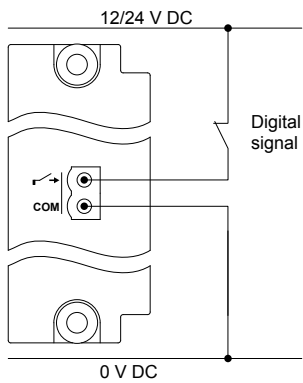

Digital input wiring for safety functions (common = 12 or 24 V)

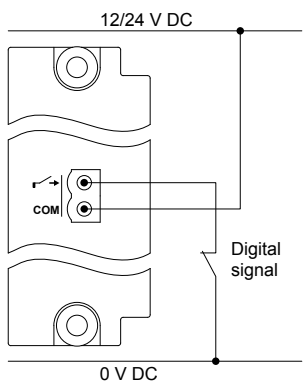

Compliance with EN60255-26

If the wire to an open contact is over 10 m long, then additional measures are required for compliance with EN60255-26. You can use a 1 k Ω resistor to common, or you can use a twisted or shielded wire to the open contact.

1 k Ω resistor to common for compliance with EN60255-26

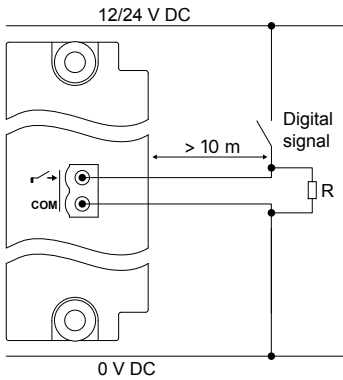

Twisted wire for compliance with EN60255-26

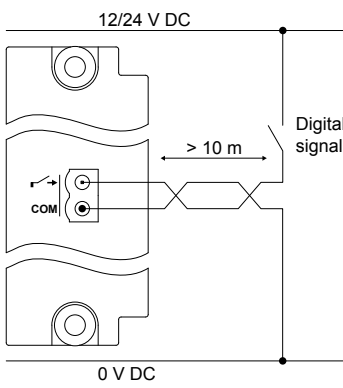

Shielded wire for compliance with EN60255-26

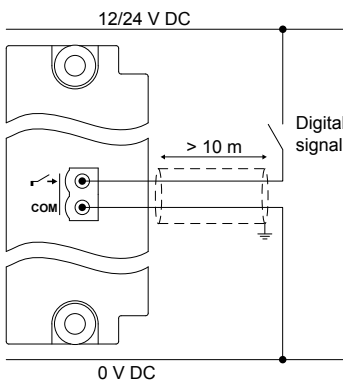

Closed contact for compliance with EN60255-26

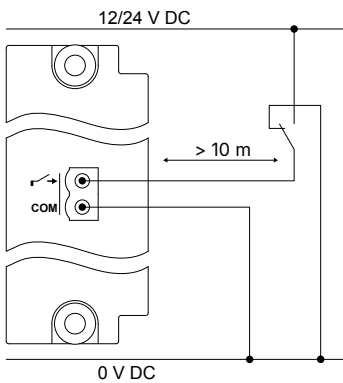

4.11 Engine interface module EIM3.1

4.11.1 EIM3.1 terminal connections

	Term	Symbol	Name	Type	Default	
<p>The diagram shows a vertical terminal block with 22 terminals. Terminal 1 is labeled 'F/G' and has a ground symbol. Terminal 2 is labeled '1' and has a positive terminal symbol. Terminal 3 is labeled '2' and has a negative terminal symbol. Terminals 3, 4, 5, 6, 7, 8, 9, and 10 are grouped as relay outputs, with symbols for normally open and common contacts. Terminals 11, 12, 13, and 14 are grouped as digital inputs, with symbols for bi-directional inputs. Terminal 15 is labeled 'COM'. Terminals 16, 17, and 18 are grouped as MPU and W inputs, with symbols for magnetic pickup and W input. Terminals 19, 20, and 21 are grouped as analogue RMI inputs, with symbols for R/I inputs. Terminal 22 is labeled 'COM'.</p>	F/G		F/G	Ground	Frame ground	
	1		+	12 or 24 V DC (nominal) *	Power supply *	
	2		-	0 V DC		
	3		Normally open	Relay output: 30 V DC and 6 A	Configurable	
	4		Common			
	5		Normally open	Relay output: 30 V DC and 6 A	Configurable	
	6		Common			
	7		Normally open	Relay output: 30 V DC and 6 A	Configurable	
	8		Common			
	9		Normally open	Relay output with wire break detection: 30 V DC and 6 A	Configurable	
	10		Common			
	11		Bi-directional input	Digital inputs: OFF: 0 to 2 V DC ON: 8 to 36 V DC Impedance: 4.7 kΩ	Configurable	
	12		Bi-directional input		Configurable	
	13		Bi-directional input		Configurable	
	14		Bi-directional input		Configurable	
	15	COM		Common	Common for digital input terminals 11 to 14	
	16		MPU input	MPU input	MPU input (Voltage: 2 to 70 V AC peak, Frequency: 2 to 20,000 Hz)	Magnetic pickup
	17	COM		Common	Common for MPU or W input	
	18	W	W input	W input	W input (Voltage: 8 to 36 V AC, Frequency: 2 to 20,000 Hz)	Generator tacho or NPN/PNP sensor
	19	R/I	Analogue RMI input	Analogue RMI input	Analogue current or resistance measurement input (RMI): Current input: 0 to 20 mA, or 4 to 20 mA Pt100/1000: -40 to 250 °C Resistance measurement: 0 to 2.5 kΩ Digital input (dry contact with cable supervision): maximum 330 Ω for ON detection Minimum current rating for connected relays: 2.5 mA	Configurable
	20	R/I	Analogue RMI input	Analogue RMI input		Configurable
	21	R/I	Analogue RMI input	Analogue RMI input		Configurable
22	COM		Common	Analogue input common		

NOTE * Some classification societies require an independent power supply for the EIM. The EIM must therefore not be connected to the same power supply source as the PSM. If used in a marine applications and the EIM3.1 is used as independent shutdown unit, maritime classification societies require an independent power supply connected to

terminals 1-2. Be aware that not all classification societies accept EIM3.1 as independent shutdown unit. Please see the type approval certificate from the classification society in question.

4.11.2 Frame ground wiring

Create a protective earth:

1. Connect the frame ground terminal to the protective earth connection.
2. Connect the frame ground terminal to the cabinet.
3. Connect the rack to the cabinet.

The frame ground is connected to the power supply terminals through transient voltage suppression diodes (transorbs). In order to protect the frame ground and power supply, max. 36 V is allowed between the frame ground and the power supply terminals.

4.11.3 Power supply wiring

Connect the power supply (+) to the 12 or 24 V DC power supply, and the power supply (-) to the 0 V DC power supply.

NOTICE

Negative power supply terminal

Do not wire the negative power supply terminal of the modules with independent power supplies (for example, PSM 3.1) to the single-phase ground. If the voltage between the power supply terminals and frame ground exceeds 36 V, the power supply terminals and the frame ground terminal will be damaged.

Recommended wiring for the power supply

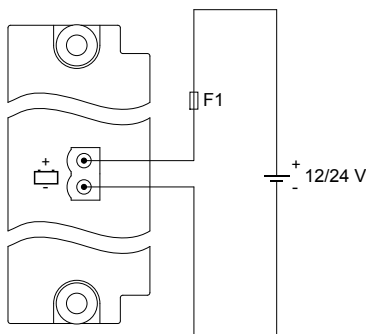

Incorrect wiring of the power supply

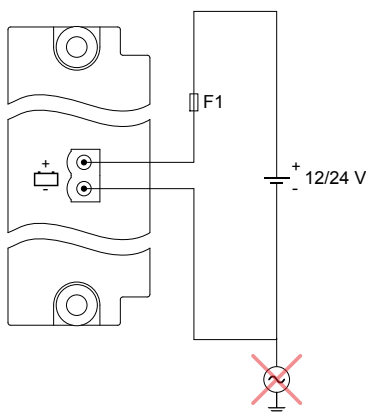

If the EIM power supply fails or is not connected, the PSM will supply power to the EIM.

If the PSM power supply fails, the EIM will run on its independent power supply. However, the EIM will not supply power to the PSM.

The equipment does not contain a backup power supply. The power supply source must therefore include the necessary power backup.

Maritime class societies require an independent power supply for the EIM. The EIM must therefore not be connected to the same power supply source as the PSM.

4.11.4 Relay output wiring

The diagram shows the connection of the relay output to an external relay. There is no voltage on the external relay when the controller relay is open.

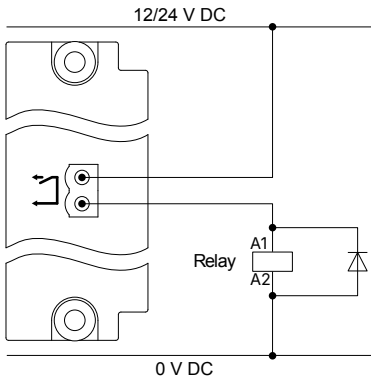

Use a diode size as recommended by the relay supplier.

You can swap the terminal connections around without affecting the performance.

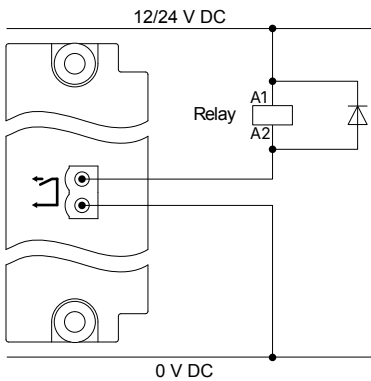

Install a freewheeling diode () to prevent a sudden voltage spike across the inductive load when the voltage source is removed.

4.11.5 Relay output with wire break detection

The diagram below shows an example of the wiring for this output.

Figure 4.13 Example: Stop coil relay with wire break detection

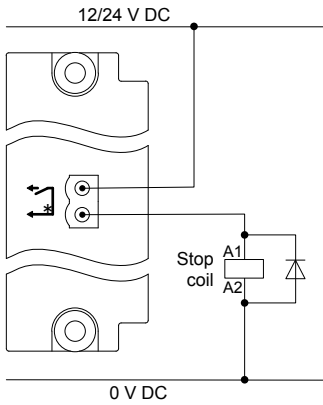

Do not connect the terminals to an alternating current supply. Alternating current will destroy the wire break detection.

The relay with wire break detection uses a small, constant current for wire break detection. This current can activate small relays, and cannot be turned off.

Remember to install the freewheeling diode (). This diode prevents a sudden voltage spike across the inductive load when the voltage source is removed.

Checking the relay size

The wire break detection current leak does not activate the relay if this formula is true:

$$V_{\text{release}} > (V_{\text{supply}} - 4.5 \text{ V}) / (3900 \Omega + R_{\text{coil}}) \times R_{\text{coil}}$$

V_{release} The release voltage for the relay (see the relay's data sheet).

V_{supply} The supply voltage that the relay is connected to (12 or 24 V).

R_{coil} The relay coil resistance (see the relay's data sheet).

This formula does not include a safety factor.

If the calculation shows that the relay is too small, use a relay with a higher release voltage and/or a smaller coil resistance.



Relay coil resistance calculation example 1

For a 24 V supply, a relay with a 7.5 V release voltage and a 630 Ω coil is proposed.

The right side of the equation is then $(24 \text{ V} - 4.5 \text{ V}) / (3900 \Omega + 630 \Omega) \times 630 \Omega = 2.7 \text{ V}$.

The release voltage (7.5 V) is more than 2.7 V. The wire break detection current leak will not activate this relay.



Relay coil resistance calculation example 2

For a 12 V supply, a relay with a 0.6 V release voltage and an 848 Ω coil is proposed.

The right side of the equation is then $(12 \text{ V} - 4.5 \text{ V}) / (3900 \Omega + 848 \Omega) \times 848 \Omega = 1.3 \text{ V}$.

The release voltage (0.6 V) is less than 1.3 V. The wire break detection current leak will activate this relay. Use a bigger relay, or use an external resistor to prevent relay activation.

Using an external resistor to prevent relay activation

If you do not need to detect a wire break in the stop coil, you can install an external resistor to stop the wire break detection current leak from activating the relay.

Figure 4.14 Wiring example for external resistor to stop the wire break current leak from activating the relay

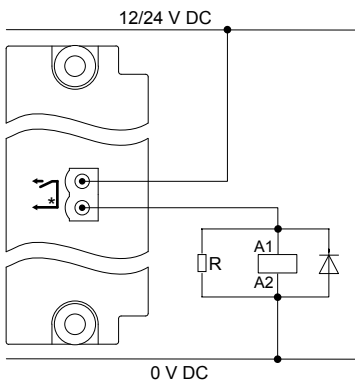

Use the following formula to calculate the maximum resistor size (in ohms):

$$R_{\text{resistor}} < R_{\text{coil}} \times V_{\text{release}} \times (2 \times R_{\text{coil}} + 7800) / (2 \times R_{\text{coil}} \times V_{\text{supply}} - 9 \times R_{\text{coil}} - 7800 \times V_{\text{release}} - 2 \times R_{\text{coil}} \times V_{\text{release}})$$

This formula does not include a safety factor.

If you get a negative result on the right side, then you do not need a resistor.



External resistor size calculation example

For a 24 V supply, a relay with a 1.2 V release voltage and a 3390 Ω coil is proposed. The wire break detection current will activate this relay, and so an external resistor is required.

The external resistor must have less resistance than:

$$3390 \times 1.2 \times (2 \times 3390 + 7800) / (2 \times 3390 \times 24 - 9 \times 3390 - 7800 \times 1.2 - 2 \times 3390 \times 1.2) = 517 \Omega$$

Use a 470 Ω resistor to stop the wire break detection current leak from activating this relay.

Use an external resistor to prevent wire break detection in the stop coil.

4.11.6 Digital input wiring

The digital inputs are bi-directional, so you can swap the terminal connections around without affecting the performance..

However, all the digital inputs in a group share a common terminal. The digital input common for a module may be either low (connected to 0 V), or high (connected to 12 or 24 V):

- If common is low: All the digital input signals connected to the group must be high (connected to 12 or 24 V).
- If common is high: All the digital input signals connected to the group must be low (connected to 0 V).

The digital input common is not used as the common for any of the other terminals on the same hardware module. The digital input common is also not affected by the digital input commons on other hardware modules.

Digital input wiring (common = 0 V)

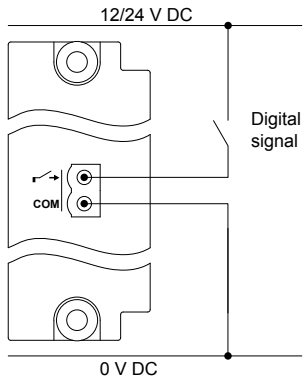

Digital input wiring (common = 12 or 24 V)

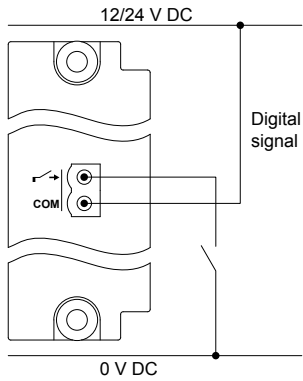

Safety function wiring

Safety functions, for example, *Emergency stop*, require a normally closed digital signal to be wired to the controller.

Digital input wiring for safety functions (common = 0 V)

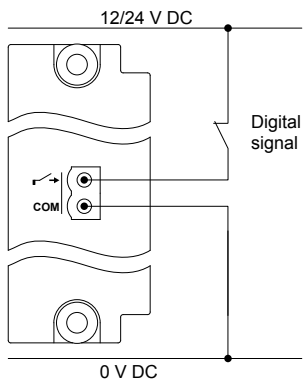

Digital input wiring for safety functions (common = 12 or 24 V)

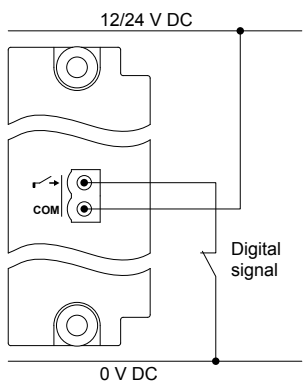

Compliance with EN60255-26

If the wire to an open contact is over 10 m long, then additional measures are required for compliance with EN60255-26. You can use a 1 k Ω resistor to common, or you can use a twisted or shielded wire to the open contact.

1 k Ω resistor to common for compliance with EN60255-26

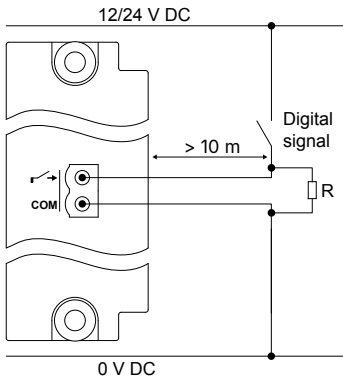

Twisted wire for compliance with EN60255-26

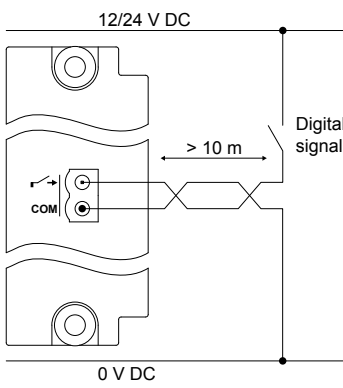

Shielded wire for compliance with EN60255-26

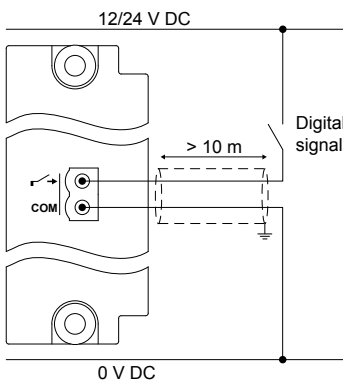

Closed contact for compliance with EN60255-26

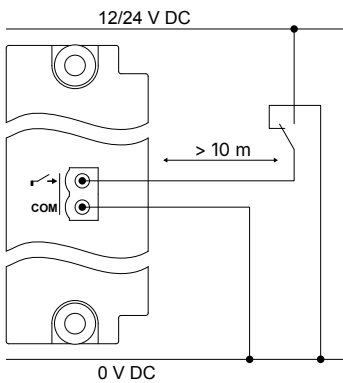

4.11.7 Magnetic pickup unit (MPU) input wiring

If you use the MPU input, you cannot at the same time use the W input. Connecting both the MPU and W inputs at the same time will lead to incorrect readings.

The MPU input wiring is shown in the following diagram. You can swap the MPU terminal connections around on the equipment without affecting the performance. If an MPU is used, a wire break can be detected.

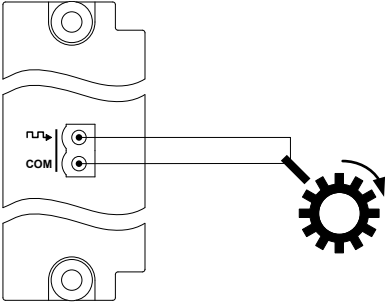

4.11.8 W input wiring

The W input can be used for a signal from one of the phases of the generator, or for an NPN or PNP input.

If you use the W input, you cannot at the same time use the MPU input. Connecting both the MPU and W inputs at the same time will lead to incorrect readings.

The connection of the W output from the generator is shown below.

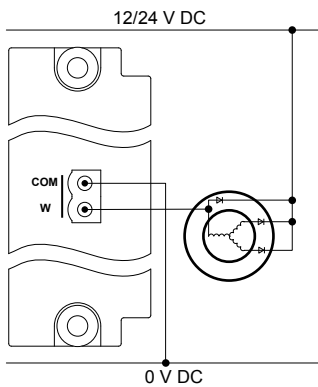

PNP input to W terminal

The connection of a PNP input, with a pull-down resistor, is shown below. The resistor, with resistance as recommended by the PNP supplier, should be placed close to the controller module.

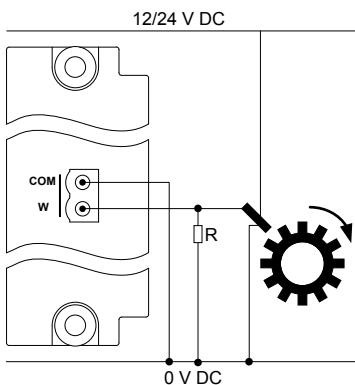

NPN input to W terminal

The connection of an NPN input, with a pull-up resistor, is shown below. The resistor, with resistance as recommended by the NPN supplier, should be placed close to the controller module.

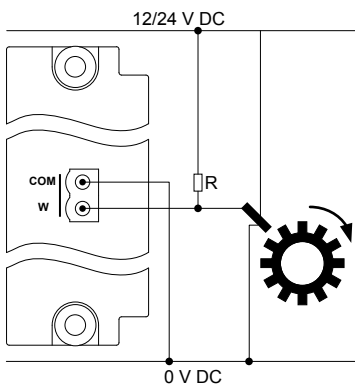

4.11.9 Analogue current or resistance inputs wiring

The I/O configuration determines whether the input is current or resistance. For resistance, the I/O configuration also determines the type of resistance input.

Current input

The current input may be either active or passive, and a combination of active and passive inputs may be used.

Figure 4.15 Connection of an active transducer

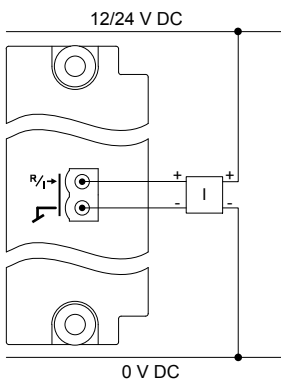
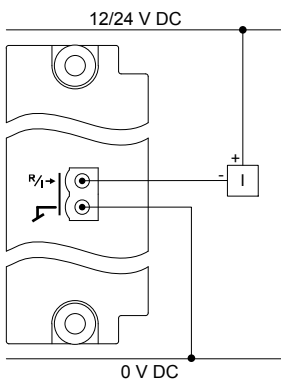

Figure 4.16 Connection of a passive transducer



Resistance input

The resistance inputs are always passive inputs. The controller sends a small current through the external equipment and measures the resistance.

NOTE There is no software compensation for the wire length to the resistance input.

Figure 4.17 Connection of a 2-wire Pt100/1000 sensor

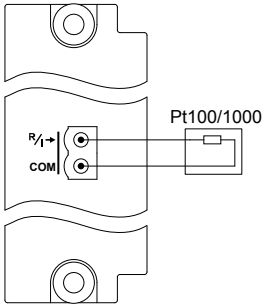
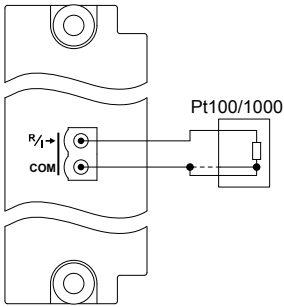
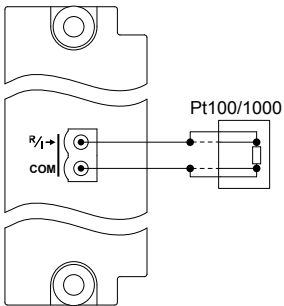

Figure 4.18 Connection of a 3-wire Pt100/1000 sensor



You do not have to connect the third wire (shown by the dashed line). If you want to connect the third wire, connect it to the common, as shown in the diagram.

Figure 4.19 Connection of a 4-wire Pt100/1000 sensor



You do not have to connect the third and fourth wires (shown by the dashed lines). If you want to connect them, connect them as shown in the diagram.

Figure 4.20 Connection of a 1-wire resistance measurement input (RMI)

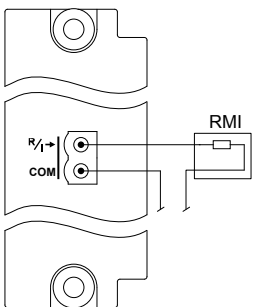

Figure 4.21 Connection of a 2-wire resistance measurement input (RMI)

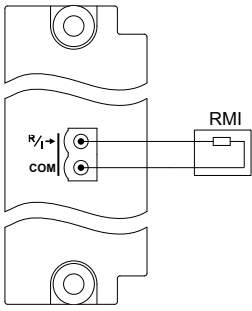
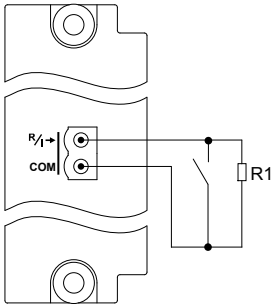

Figure 4.22 Connection of a dry contact with cable supervision



Requirements:

- The maximum resistance for the circuit and resistor ($R1$) is 330 Ω .
- $R1$ must be connected to the switch, and not to the controller terminals.

Figure 4.23 Connection of a dry contact with cable supervision, and short circuit detection

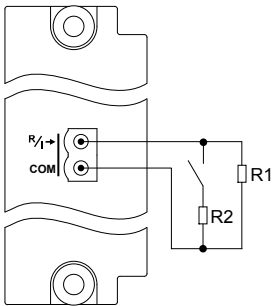

Requirements:

- The maximum resistance for the circuit and resistor ($R1$) is 330 Ω .
- The resistance of $R2$ must be less than $R1$.
- $R1$ must be connected to the switch, and not to the controller terminals.

4.12 Governor and AVR module GAM3.1

4.12.1 GAM3.1 terminal connections

	Term	Symbol	Name	Type	Default
	1	↔	Normally open	Relay output (250 V AC or 30 V DC, and 6 A)	Configurable
	2	↔	Common		
	3	↔	Normally open	Relay output (250 V AC or 30 V DC, and 6 A)	Configurable
	4	↔	Common		
	5	↔	Normally open	Relay output (250 V AC or 30 V DC, and 6 A)	Configurable
	6	↔	Common		
	7	↔	Normally open	Relay output (250 V AC or 30 V DC, and 6 A)	Configurable
	8	↔	Common		
	9	↔ _P	Active (P) load	Voltage output: -5 to 5 V DC, Impedance: 23.5 kΩ	
	10	COM	Common	Common to terminals 9 or 10	
	11	↔ _Q	Reactive (Q) var	Voltage output: -5 to 5 V DC, Impedance: 23.5 kΩ	
	12	↔ _{I/V}	Output	Analogue current or voltage output: Current: 0 to 20 mA, 4 to 20 mA, or -20 to 20 mA Voltage (DC): 0 to 10 V, -10 to 10 V, 0 to 5 V, 0 to 3 V, -3 to 3 V, 0 to 1 V	
	13	↔	Common		
	14	↔ _{PWM}	PWM output	Frequency: 500 Hz ±50 Hz, Resolution: 43,200 levels, Voltage: 0.05 to 6.85 V	Pulse width modulation (PWM) output
	15	↔	Common		
	16	↔ _{I/V}	Output	Analogue current or voltage output: Current: 0 to 20 mA, 4 to 20 mA, or -20 to 20 mA Voltage (DC): 0 to 10 V, -10 to 10 V, 0 to 5 V, 0 to 3 V, -3 to 3 V, 0 to 1 V	Configurable
	17	↔	Common		
	18	↔ _{I/V}	Input	Analogue current or voltage input: Current: 0 to 20 mA, or 4 to 20 mA Voltage (DC): -10 to 10 V, 0 to 10 V	Configurable
	19	↔	Common		
	20	↔ _{I/V}	Input	Analogue current or voltage input: Current: 0 to 20 mA, or 4 to 20 mA Voltage (DC): -10 to 10 V, 0 to 10 V	Configurable
	21	↔	Common		

4.12.2 Relay output wiring

The diagram shows the connection of the relay output to an external relay. There is no voltage on the external relay when the controller relay is open.

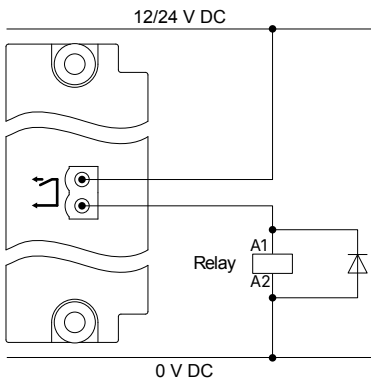

Use a diode size as recommended by the relay supplier.

You can swap the terminal connections around without affecting the performance.

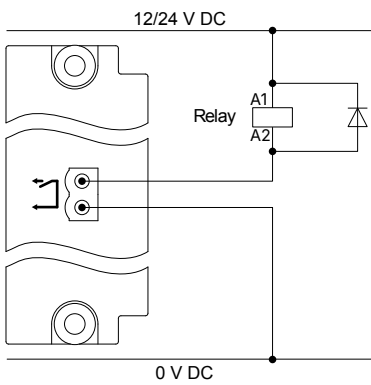

Install a freewheeling diode () to prevent a sudden voltage spike across the inductive load when the voltage source is removed.

4.12.3 Load sharing wiring

The active (P) and reactive (Q) load sharing terminals on the GAM3.1 module are reserved for future use for analogue load sharing.

4.12.4 Analogue current or voltage outputs wiring

The diagram below shows the connection of an external controller to the DEIF controller's analogue current or voltage output. The I/O configuration determines whether the output is current or voltage.

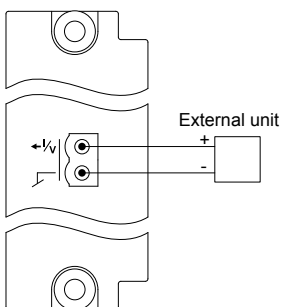

NOTICE

Terminal damage

These outputs are active outputs. Do not connect an external power supply to these terminals. Connecting an external power supply may damage the terminals.

The PWM output is galvanically connected to the first analogue output (terminals 12 and 13) on GAM3.1. This means that wiring errors or noise on either output can affect the other output.

Using an analogue output with a switchboard instrument

The analogue output can be connected directly to a 4 to 20 mA switchboard instrument.

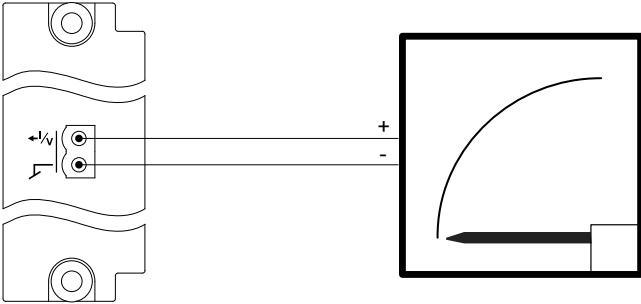

We recommend using switchboard instruments from the DEIF DQ moving coil instrument series. See <http://www.deif.com> for more information.

4.12.5 Pulse width modulation (PWM) output wiring

Pulse width modulation (PWM) output is normally used to control a governor. The PWM could also be used as an input for another controller, as shown in the diagram below.

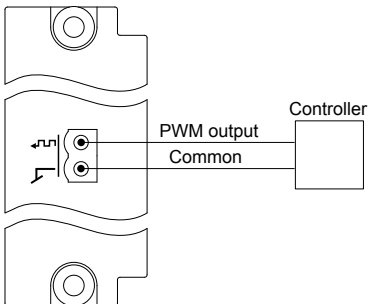

NOTE The PWM output is galvanically connected to the first analogue output (terminals 12 and 13) on GAM3.1. This means that wiring errors or noise on either output can affect the other output.

4.12.6 Analogue current or voltage input wiring

The I/O configuration determines whether the input is current or voltage.

Configure the terminals correctly (that is, for current or for voltage) before connecting the external transmitter.

Current input

The current input may be either active or passive.

The following diagram shows the connection of an active transducer.

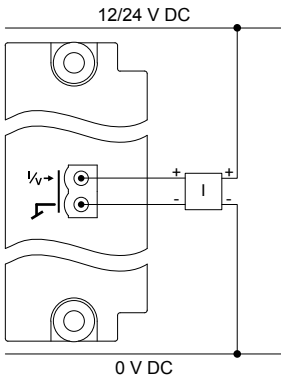

The following diagram shows the connection of a passive transducer.

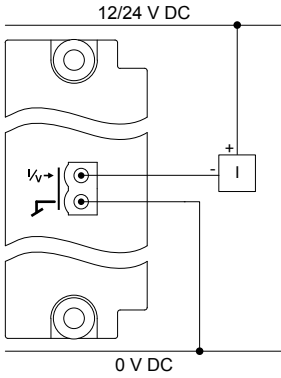

The two analogue inputs on GAM3.1 are galvanically connected. You therefore cannot use the analogue inputs on GAM3.1 in series with each other, for example, if you wanted a backup measurement. If you need two analogue inputs in series, you can use an analogue input on another module in series with an analogue input on GAM3.1, since the modules are galvanically isolated from each other.

Voltage input

The following diagram shows the connection for voltage input.

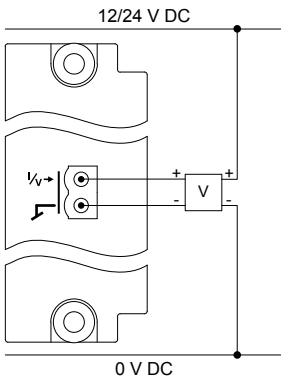

4.13 Governor and AVR module GAM3.2

4.13.1 GAM3.2 terminal connections

	Term	Symbol	Name	Type	Default
	FG		F/G	Ground	Frame ground
	1		+	12 or 24 V DC (nominal)	Power supply
	2		-	0 V DC	
	3		Analogue output	Analogue current or voltage output (Current: 0 to 20 mA, 4 to 20 mA, or -20 to 20 mA; Voltage (DC): 0 to 10 V, -10 to 10 V, 0 to 5 V, 0 to 3 V, -3 to 3 V, or 0 to 1 V)	Configurable
	4		Common		
	5		Analogue output	Analogue current or voltage output (Current: 0 to 20 mA, 4 to 20 mA, or -20 to 20 mA; Voltage (DC): 0 to 10 V, -10 to 10 V, 0 to 5 V, 0 to 3 V, -3 to 3 V, or 0 to 1 V)	Configurable/ PWM output
	6	COM	Common		
	7		PWM output	Pulse width modulation (PWM) output (Frequency: 500 Hz \pm 50 Hz, Resolution: 43,200 levels, Voltage: 0.05 to 6.85 V)	
	8		Bi-directional input	Digital input (OFF: 0 to 2 V DC, ON: 8 to 36 V DC, Impedance: 4.7 k Ω)	Configurable
	9		Bi-directional input	Digital input (OFF: 0 to 2 V DC, ON: 8 to 36 V DC, Impedance: 4.7 k Ω)	Configurable
	10		Bi-directional input	Digital input (OFF: 0 to 2 V DC, ON: 8 to 36 V DC, Impedance: 4.7 k Ω)	Configurable
	11		Bi-directional input	Digital input (OFF: 0 to 2 V DC, ON: 8 to 36 V DC, Impedance: 4.7 k Ω)	Configurable
	12		Bi-directional input	Digital input (OFF: 0 to 2 V DC, ON: 8 to 36 V DC, Impedance: 4.7 k Ω)	Configurable
	13	COM	Common	Common for digital input terminals 8 to 12	
	14		Normally open	Relay output (250 V AC or 30 V DC, and 6 A)	GAM3.2 # status OK *
	15		Common		
	16		Normally open	Relay output (250 V AC or 30 V DC, and 6 A)	Configurable
	17		Common		
	18		Normally open	Relay output (250 V AC or 30 V DC, and 6 A)	Configurable
	19		Common		
	20		Normally open	Relay output (250 V AC or 30 V DC, and 6 A)	Configurable
	21		Common		
	22		Normally open	Relay output (250 V AC or 30 V DC, and 6 A)	Configurable
23		Common			

NOTE * Default function cannot be changed.

4.13.2 Frame ground wiring

Create a protective earth:

1. Connect the frame ground terminal to the protective earth connection.
2. Connect the frame ground terminal to the cabinet.
3. Connect the rack to the cabinet.

The frame ground is connected to the power supply terminals through transient voltage suppression diodes (transorbs). In order to protect the frame ground and power supply, max. 36 V is allowed between the frame ground and the power supply terminals.

4.13.3 Power supply wiring

Connect the power supply (+) to the 12 or 24 V DC power supply, and the power supply (-) to the 0 V DC power supply.

NOTICE

Negative power supply terminal

Do not wire the negative power supply terminal of the modules with independent power supplies (for example, PSM 3.1) to the single-phase ground. If the voltage between the power supply terminals and frame ground exceeds 36 V, the power supply terminals and the frame ground terminal will be damaged.

Recommended wiring for the power supply

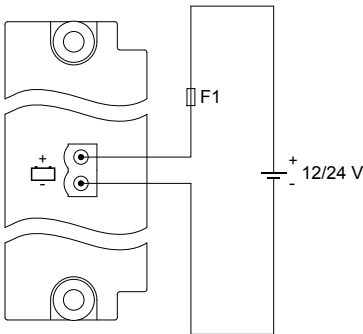

Incorrect wiring of the power supply

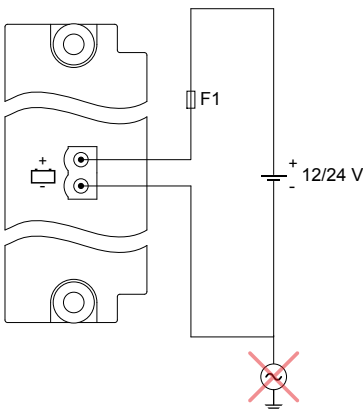

Backup power supply

The equipment does not contain a backup power supply. The power supply source must therefore include the necessary power backup.

Example of a power supply and backup connected to the power supply terminals

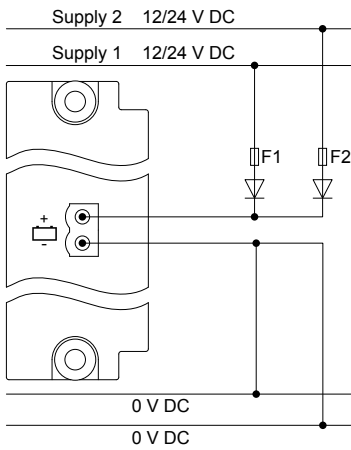

We recommend a 2 A time-delay fuse for 24 V DC and a 4 A time-delay fuse for 12 V DC for F1 and F2, and that the diodes are rated 50V or higher.

NOTICE



Nominal auxiliary voltage is 12 or 24V DC (8 to 36 V DC operating range).

If voltage drops are likely to appear, a 7 A time-delay fuse is needed.

4.13.4 Analogue current or voltage outputs wiring

The diagram shows the connection of an external controller to the DEIF controller's analogue current or voltage output. The I/O configuration determines whether the output is current or voltage.

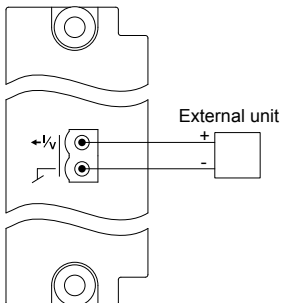

NOTICE

Terminal damage

These outputs are active outputs. Do not connect an external power supply to these terminals. Connecting an external power supply may damage the terminals.

Analogue output with an external instrument

The analogue output can be connected directly to a 4 to 20 mA external instrument.

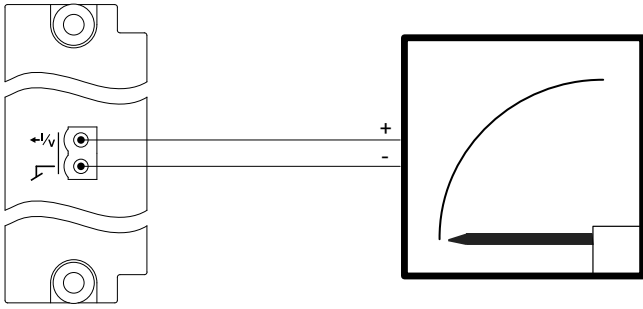

We recommend you use instruments from the DEIF DQ moving coil instrument series. See www.deif.com for more information.

4.13.5 Pulse width modulation (PWM) output wiring

Pulse width modulation (PWM) output is normally used to control a governor, but you can also use the PWM as an input for another controller.

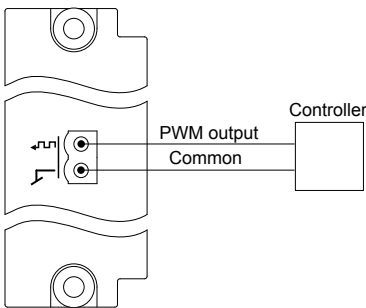

4.13.6 Digital input wiring

The digital inputs are bi-directional, so you can swap the terminal connections around without affecting the performance..

However, all the digital inputs in a group share a common terminal. The digital input common for a module may be either low (connected to 0 V), or high (connected to 12 or 24 V):

- If common is low: All the digital input signals connected to the group must be high (connected to 12 or 24 V).
- If common is high: All the digital input signals connected to the group must be low (connected to 0 V).

The digital input common is not used as the common for any of the other terminals on the same hardware module. The digital input common is also not affected by the digital input commons on other hardware modules.

Digital input wiring (common = 0 V)

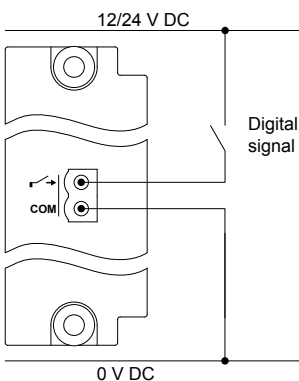

Digital input wiring (common = 12 or 24 V)

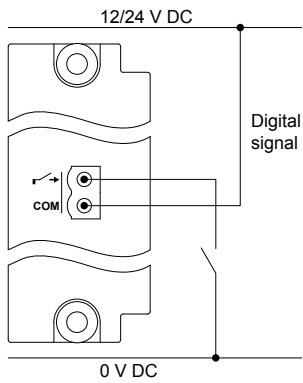

Safety function wiring

Safety functions, for example, *Emergency stop*, require a normally closed digital signal to be wired to the controller.

Digital input wiring for safety functions (common = 0 V)

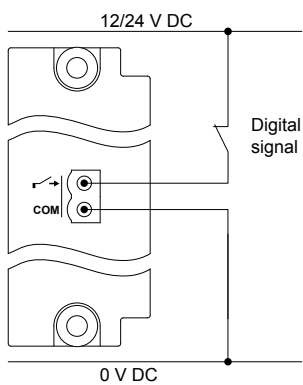

Digital input wiring for safety functions (common = 12 or 24 V)

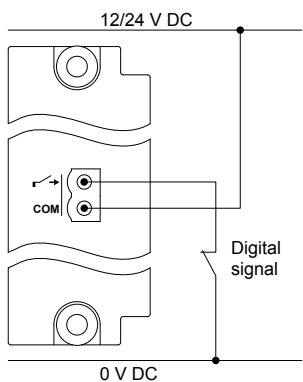

Compliance with EN60255-26

If the wire to an open contact is over 10 m long, then additional measures are required for compliance with EN60255-26. You can use a 1 k Ω resistor to common, or you can use a twisted or shielded wire to the open contact.

1 kΩ resistor to common for compliance with EN60255-26

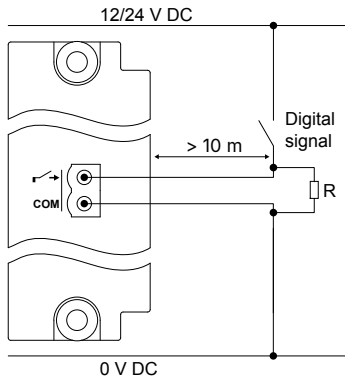

Twisted wire for compliance with EN60255-26

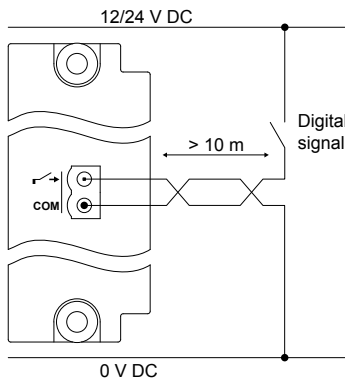

Shielded wire for compliance with EN60255-26

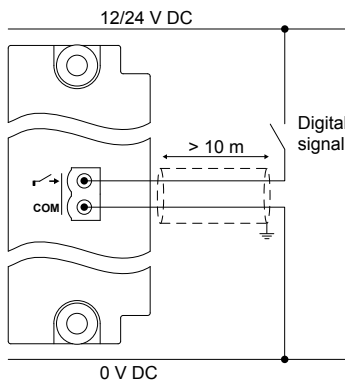

Closed contact for compliance with EN60255-26

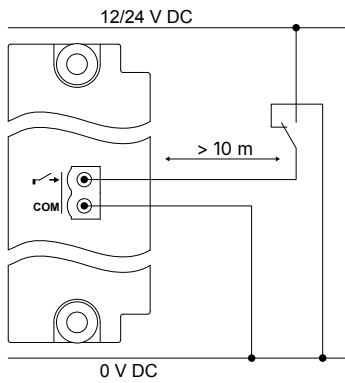

4.13.7 Relay output wiring

The diagram shows the connection of the relay output to an external relay. There is no voltage on the external relay when the controller relay is open.

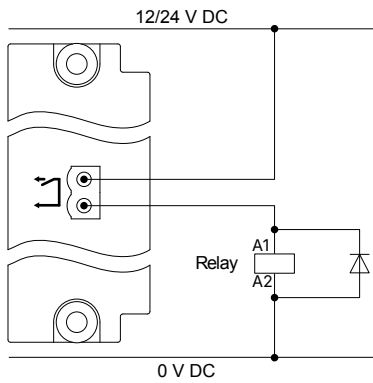

Use a diode size as recommended by the relay supplier.

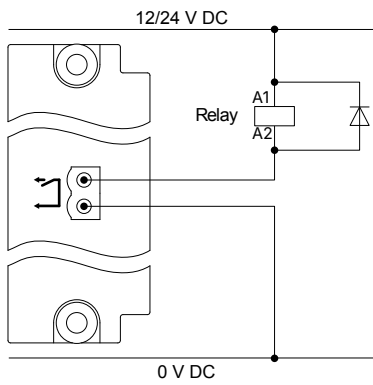

You can swap the terminal connections around without affecting the performance.



Install a freewheeling diode () to prevent a sudden voltage spike across the inductive load when the voltage source is removed.

4.14 Processor and communication module PCM3.3

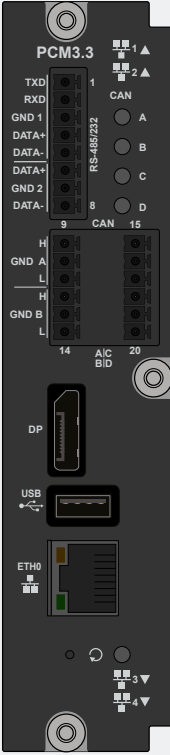
4.14.1 PCM3.3 terminal connections

Module	Count	Symbol	LED	Type	Name
	5	ETH0 1 to 4	<ul style="list-style-type: none"> ● Off : No communication ● Green : Communication connected 🌟 Green flash : Active communication 	Ethernet (RJ45)	ETH0 on the front. Switch Ports 1 and 2 (SWP1, SWP2) located connections at the top. Switch Ports 3 and 4 (SWP3, SWP4) located connections at the bottom.
	1		<ul style="list-style-type: none"> ● Off : Self-check not OK ● Green : Self-check OK 🌟 Green flash : In service mode 		
	1			Internal push-button *	
	1	USB		USB host (Type-A)	
	1	DP		DisplayPort (DP full size)	
	4	A to D H, GND, L	<ul style="list-style-type: none"> ● Off : No communication ● Green : CAN connected 🌟 Green flash : Active CAN communication 	CAN port	CAN bus
	1			RS-232/485 port	
	1			RS-485 port	

NOTE * Used for Factory reset. Can also be used with CODESYS if license is installed.

4.14.2 CAN bus ECU or DAVR communication

The CAN bus terminals on the PCM3.3 module can be used for communication with an ECU and/or DAVR.

Use 120 Ω (Ohm) shielded twisted pair cable. Terminating resistors at the ends of the cable must be 120 Ω (Ohm).

The ECU may include a terminating resistor (see the engine manufacturer's information).



Example cable

Belden 3105A or equivalent, 22 AWG (0.33 mm²) twisted pair, shielded, impedance 120 Ω (Ohm), < 50 m Ω /m, min. 95 % shield coverage.

Wiring to ECU only

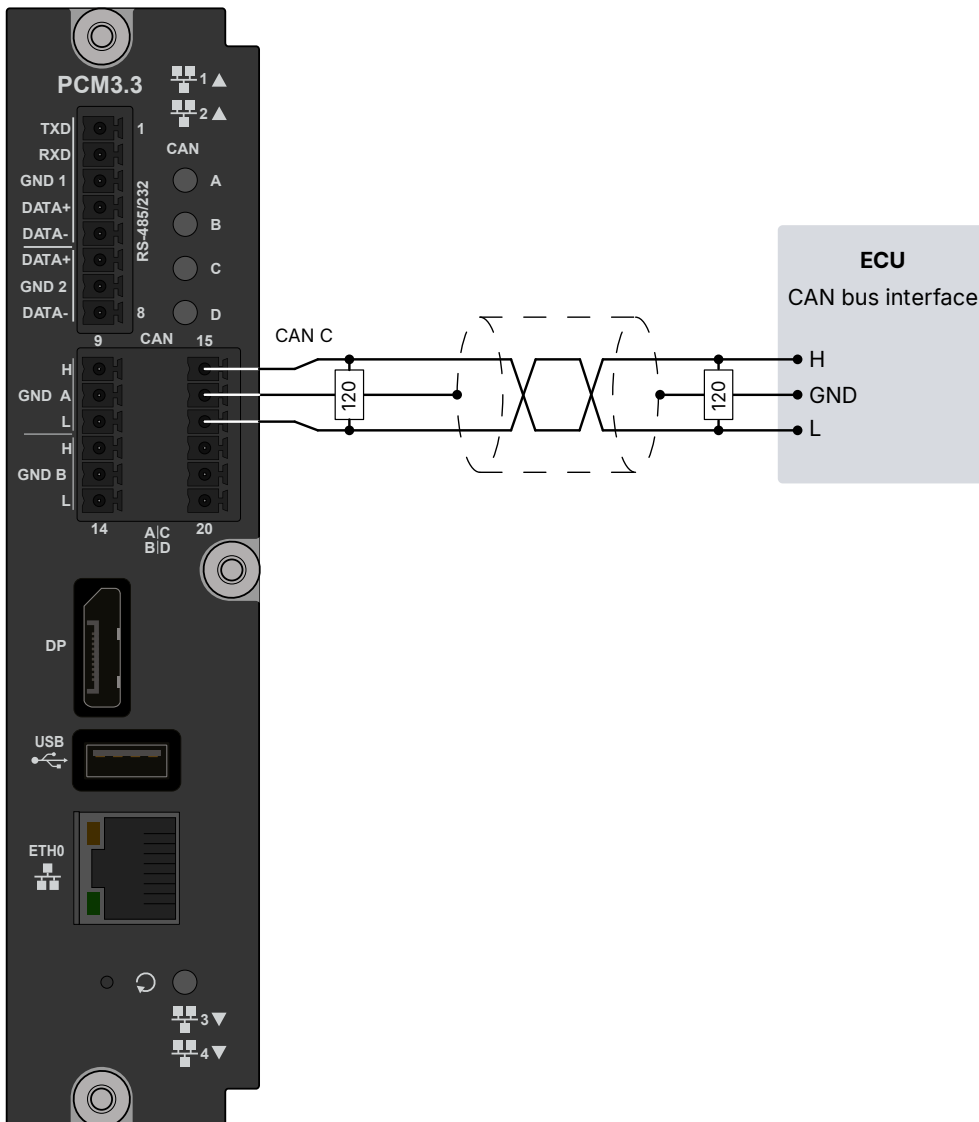

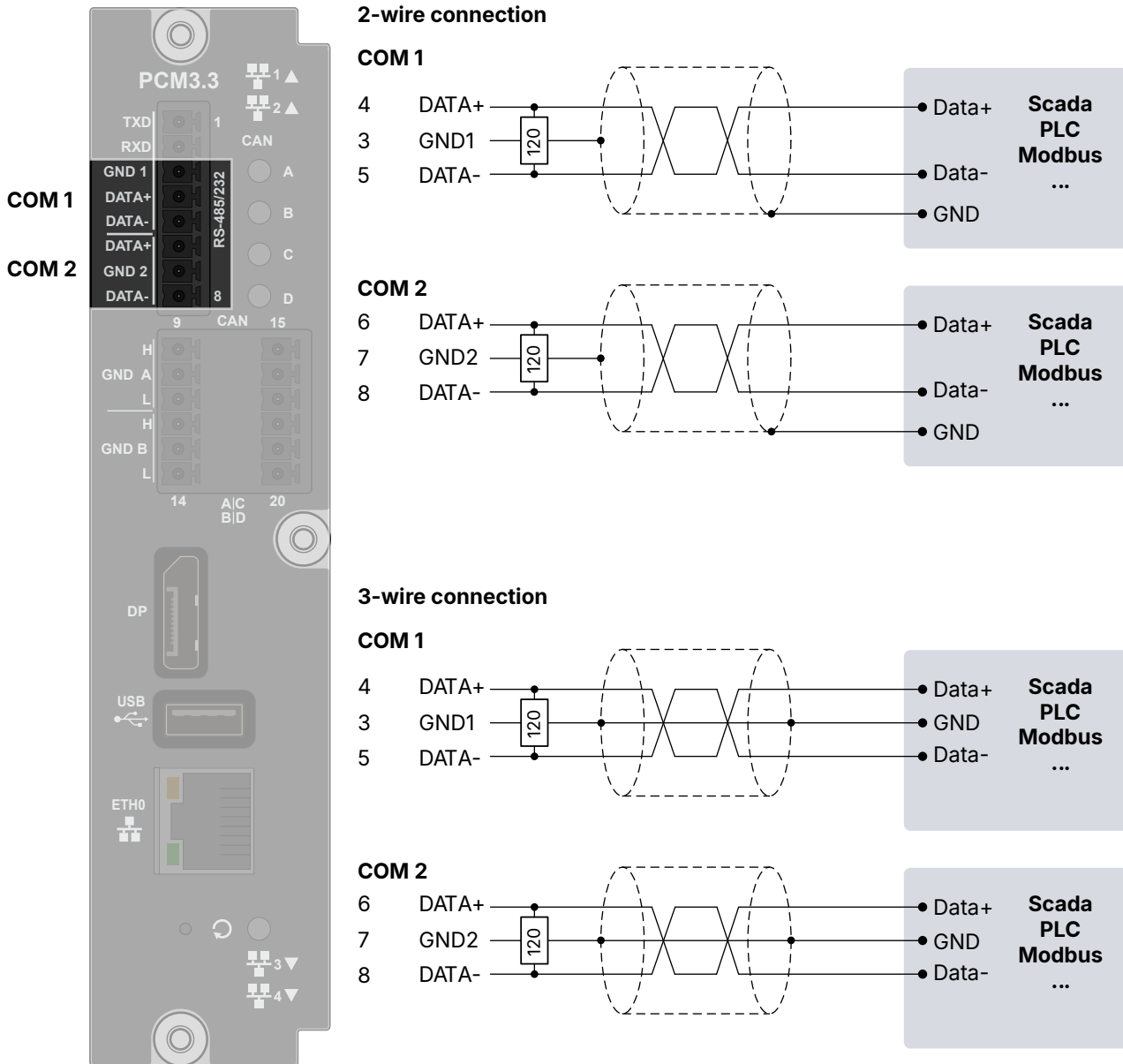





4.14.4 PCM3.3 Network connections

The Ethernet connections are used for both internal and external communication. Internal communication for PICUS, Display and Power management to other controllers. External communication for SCADA, Modbus TCP, or AMS.

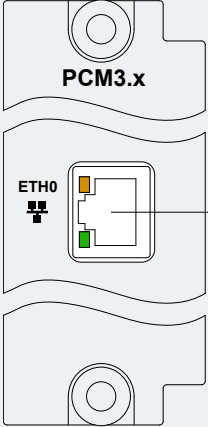
Table 4.5 Location of the network communication ports on PCM3.3

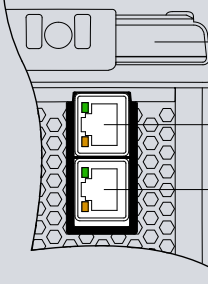
Symbol	Symbol	Port location	Notes
		Top of rack, top port	Network communication.
		Top of rack, bottom port	Network communication.

Symbol	Symbol	Port location	Notes
 <p>PCM3.x</p> <p>ETH0</p>	 ETH0	Port on faceplate	Network communication (ETH0).
 <p>PCM3.x</p> <p>3</p> <p>4</p>	 3	Bottom of rack, top port	Network communication.
	 4	Bottom of rack, bottom port	Network communication.

Configurable Ethernet ports

The Ethernet ports on the PCM3.3 are not assigned to a particular service. By default these are configured as **Automatic**. The controllers detect the equipment connected to the port. You can also configure the controller rack ports for specific use by using PICUS.

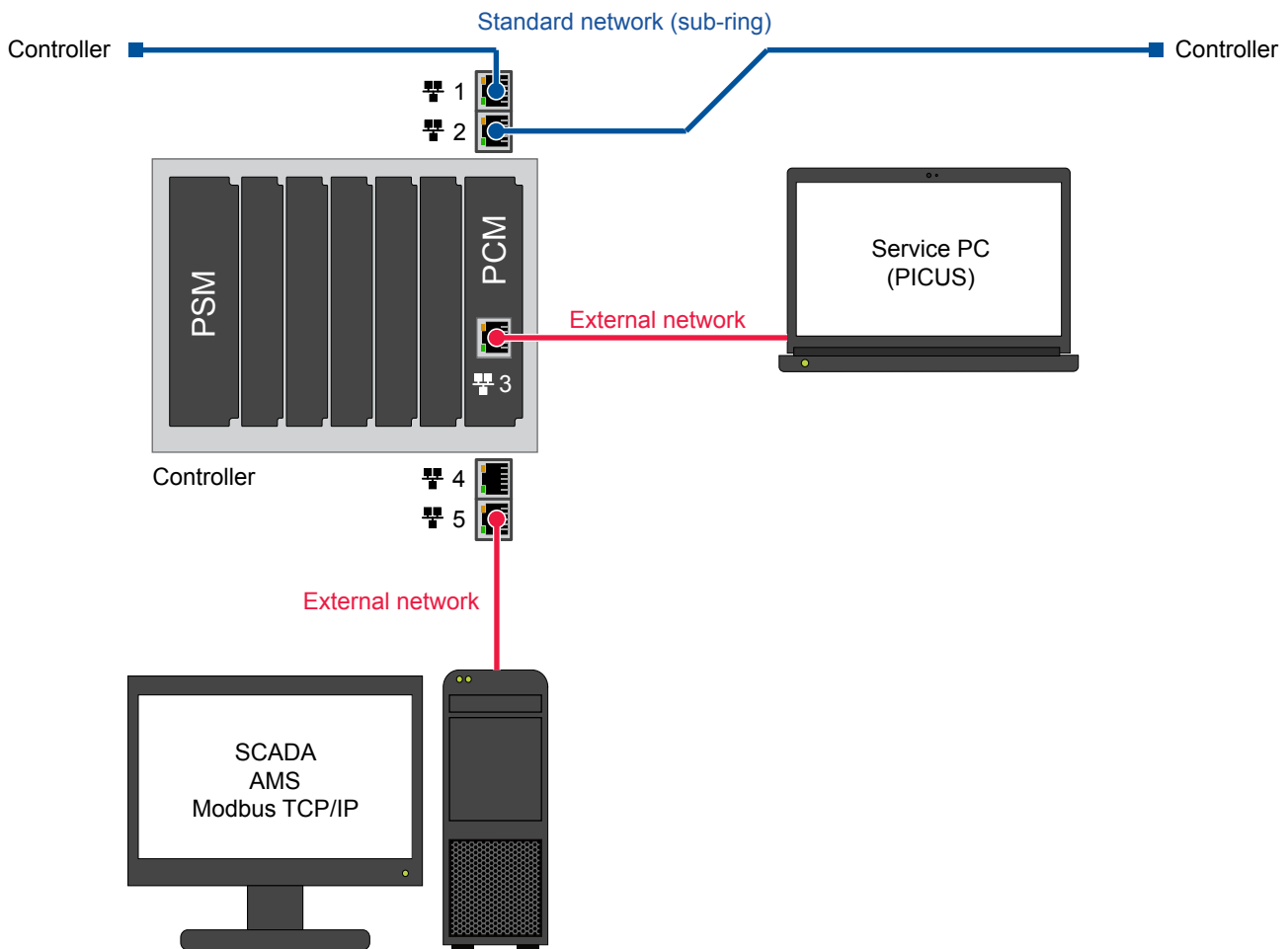

Network restrictions

- Controllers must be connected with **Network chain** or **Network ring** configurations.
- Up to 32 controllers can be connected to each other in each network. Display units can be connected to the controllers without having any effect on the maximum number of controllers in the network.
- The Ethernet cables must not be longer than 100 metres, point-to-point.
- The Ethernet cables must meet or exceed the SF/UTP CAT5e specification.
- The network to PICUS, SCADA, AMS and/or Modbus must be connected to the controllers as branches of the **Network chain** or **Network ring**. Do not place these network connections inside the network chain or ring.
- If you use an Ethernet switch, this must support and be enabled for Rapid Spanning Tree Protocol (RSTP), otherwise a broadcast storm will occur.
- For maritime applications, a maritime classification society approved managed switch should be used to connect the DEIF network to your own network. (An ordinary Ethernet switch is not recommended).
- The internal communication ports on the PSM must not be used for the network communication. They are used to connect controllers to extension racks.

NOTICE



Cybersecurity

Connections to untrusted networks may require additional equipment or security counter-measures not included in the product.

Ethernet port protectors

The controllers have two Ethernet port protectors that cover the Ethernet ports on the top of the controller to protect from dust or other foreign objects during the installation. We recommend that the port protectors remain installed in the ports when these are not in use.

Cable bend radius

Bends in the cables must not be tighter than the minimum bend radius specified by the cable manufacturer. We recommend that you always follow the cable manufacturer's bend radius requirements.

Redundancy and routing

Each controller can be connected so that there is redundant communication. This means that there are two independent connections to other controllers. If you need redundant communication, you should route the cables for redundancy. A single failure (for example, damage to a cable rack) should not damage both of the connections to the other controllers.

4.14.5 External third-party display

External third-party non-DEIF displays connected to the DisplayPort, should be configured to **Input** mode instead of **Automatic** detection.

4.14.6 Topology restrictions

Network star *

The controllers are connected through a switch. Configure Ethernet port 1 on each controller as **External network/PICUS**.

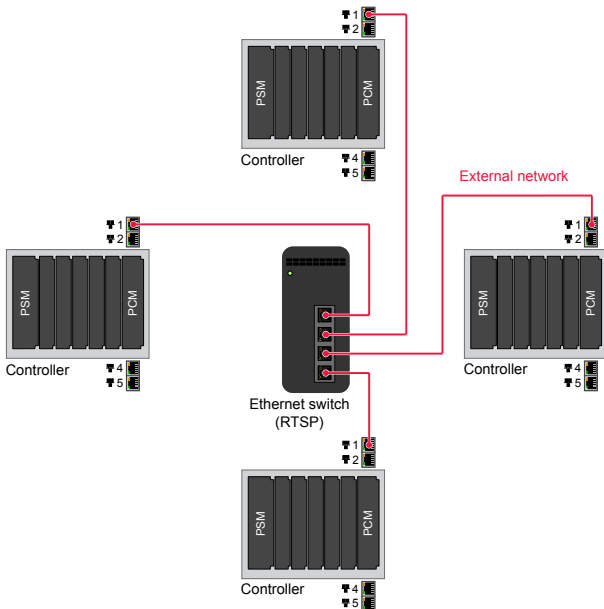

NOTE * Power management system (PMS) is not supported with this topology.

4.14.7 Topology examples

Controllers must be connected with either **Network chain** or **Network ring** configurations. You can also use redundant connections or interleaving.

As a minimum, only one connection from the controller to another controller in the DEIF network is required.

Network chain

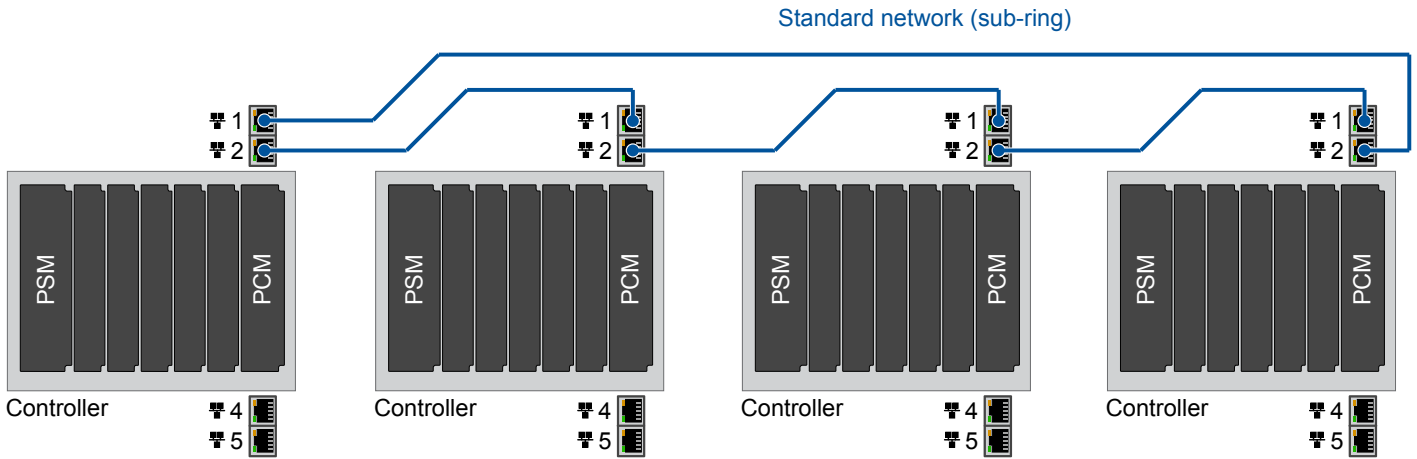

Network ring

A branch of the network ring can be connected to a SCADA server, an alarm monitoring system (AMS) and/or a service PC.

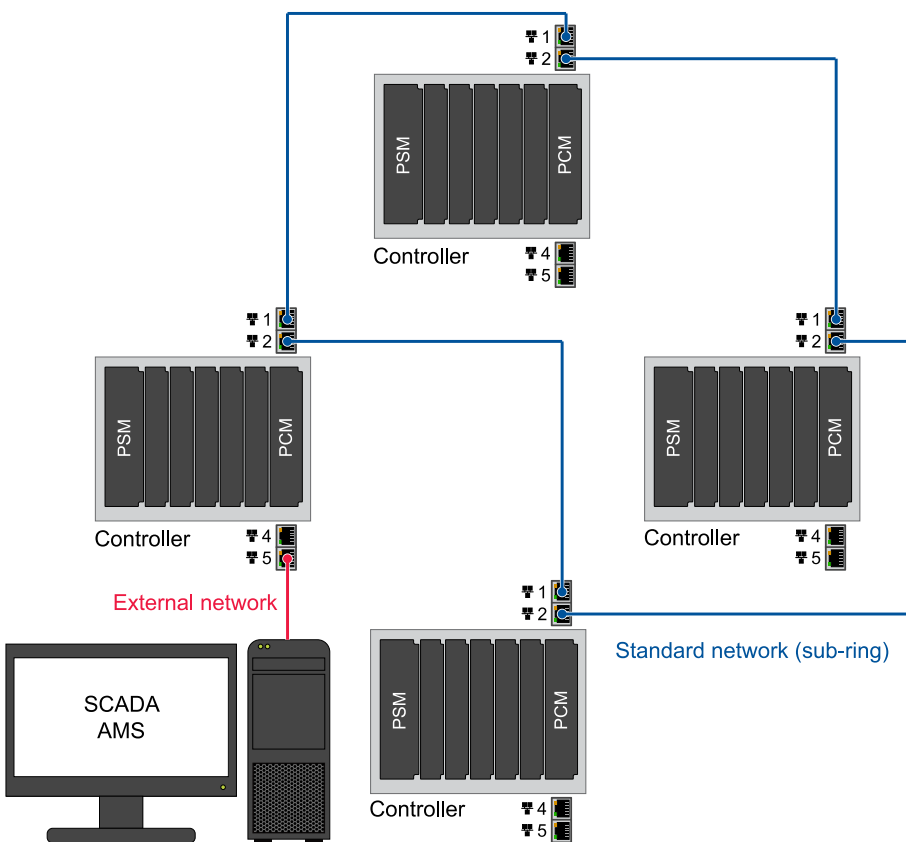

Interleaving

To avoid a long return connection for a long row of controllers, you can "interleave" the controller connections.

1. Connect each controller to the controller one step away, that is, connect 1 and 3 (blue), 2 and 4 (orange), 3 and 5 (green). Make sure the cable paths are separated to minimise the risk of damaging two cables at the same time.
2. Connect the first two controllers to each other (red).
3. Connect the last two controllers to each other (red).

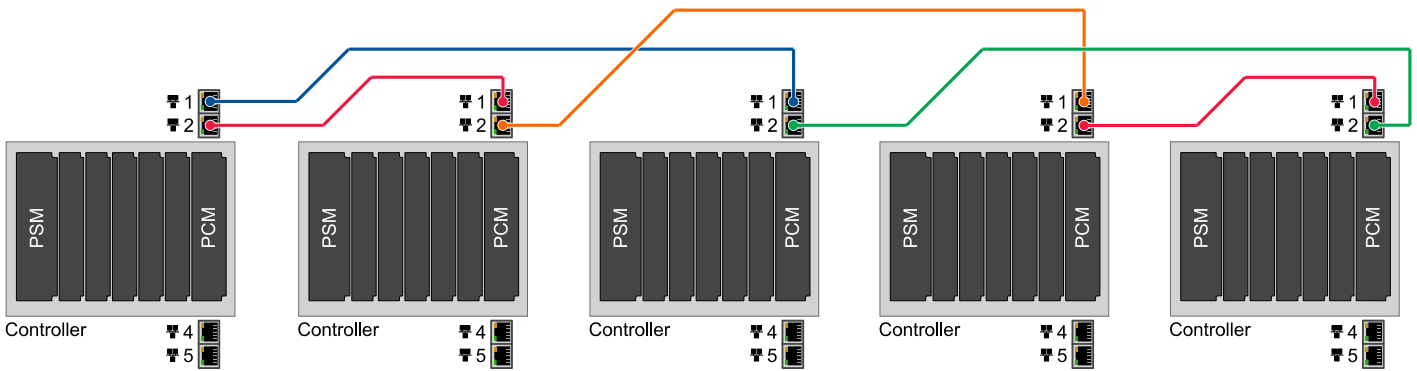

Redundant connection to SCADA or AMS

The network rings can be connected to a SCADA server, or an alarm monitoring system (AMS), with a redundant connection to two different controllers. This requires a switch that supports and has enabled Rapid Spanning Tree Protocol (RSTP).

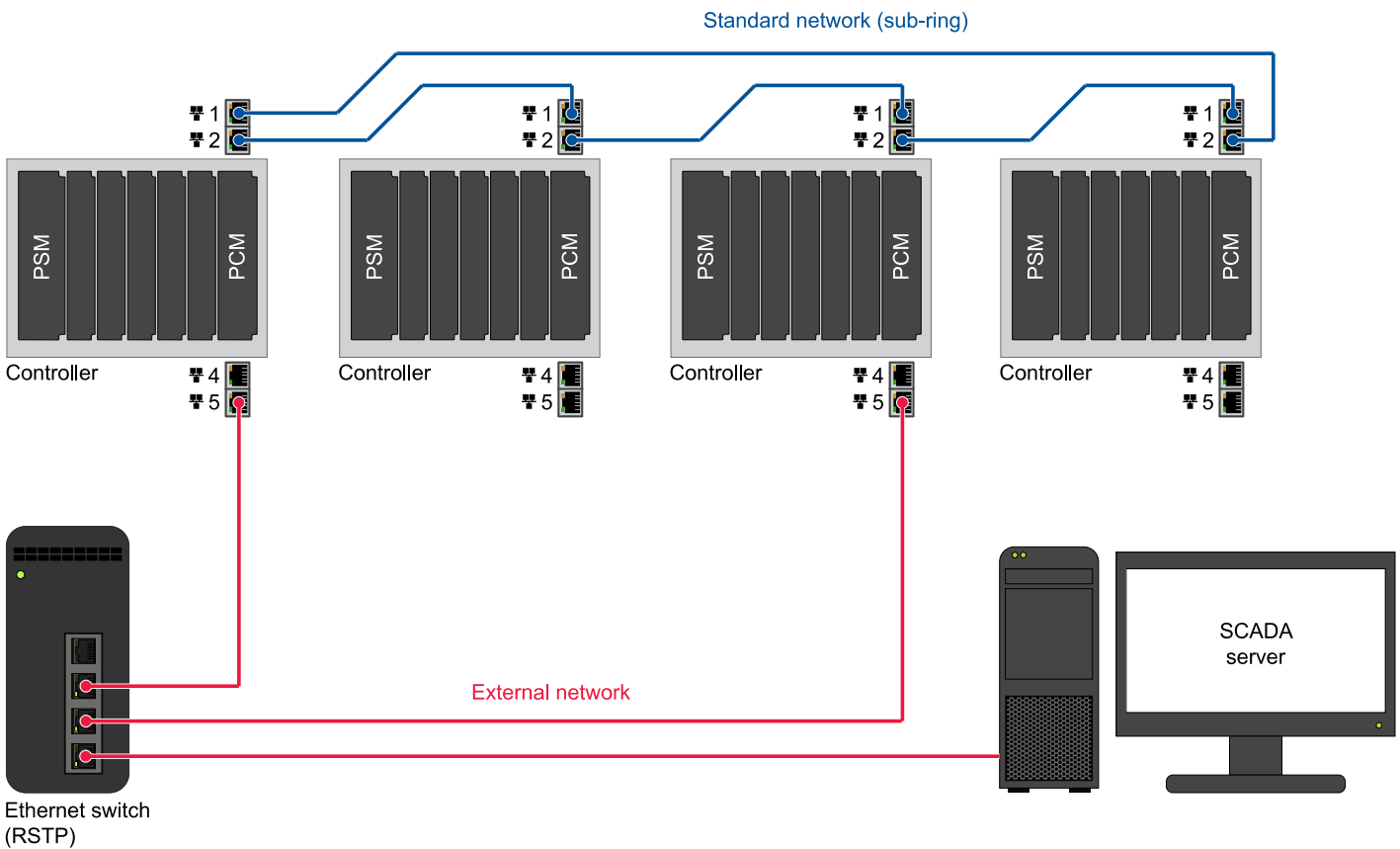

4.15 Example wiring for controller functions

4.15.1 System AC configuration

Examples are given for each AC configuration wiring type. The examples show grounding on the S2 side of the current transformers. You can choose to ground the S1 side of the current transformers instead.

Dashed lines show optional wiring.

Three-phase (2 CT, L1-L3) AC wiring

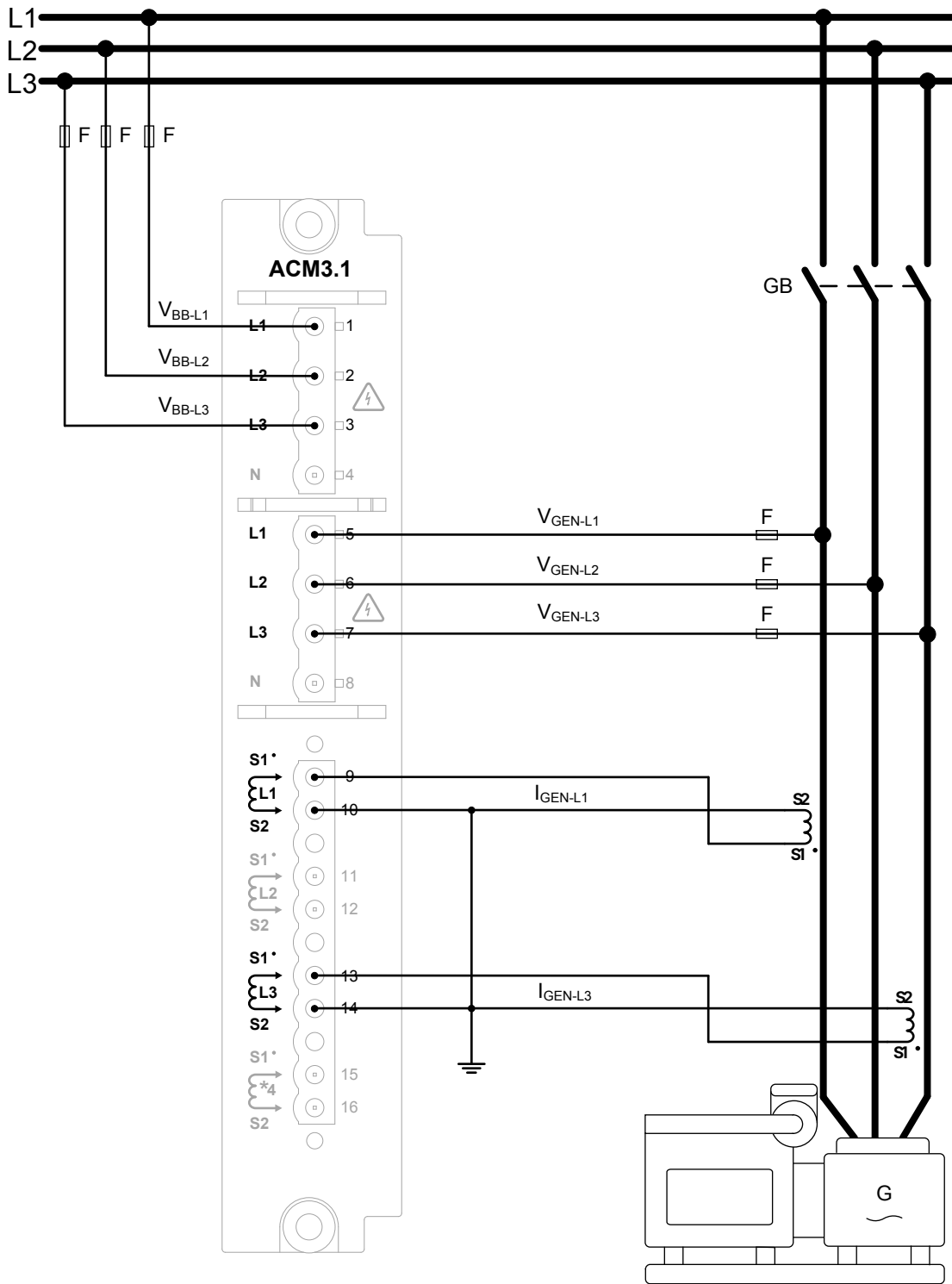

Single-phase wiring (L1 example)

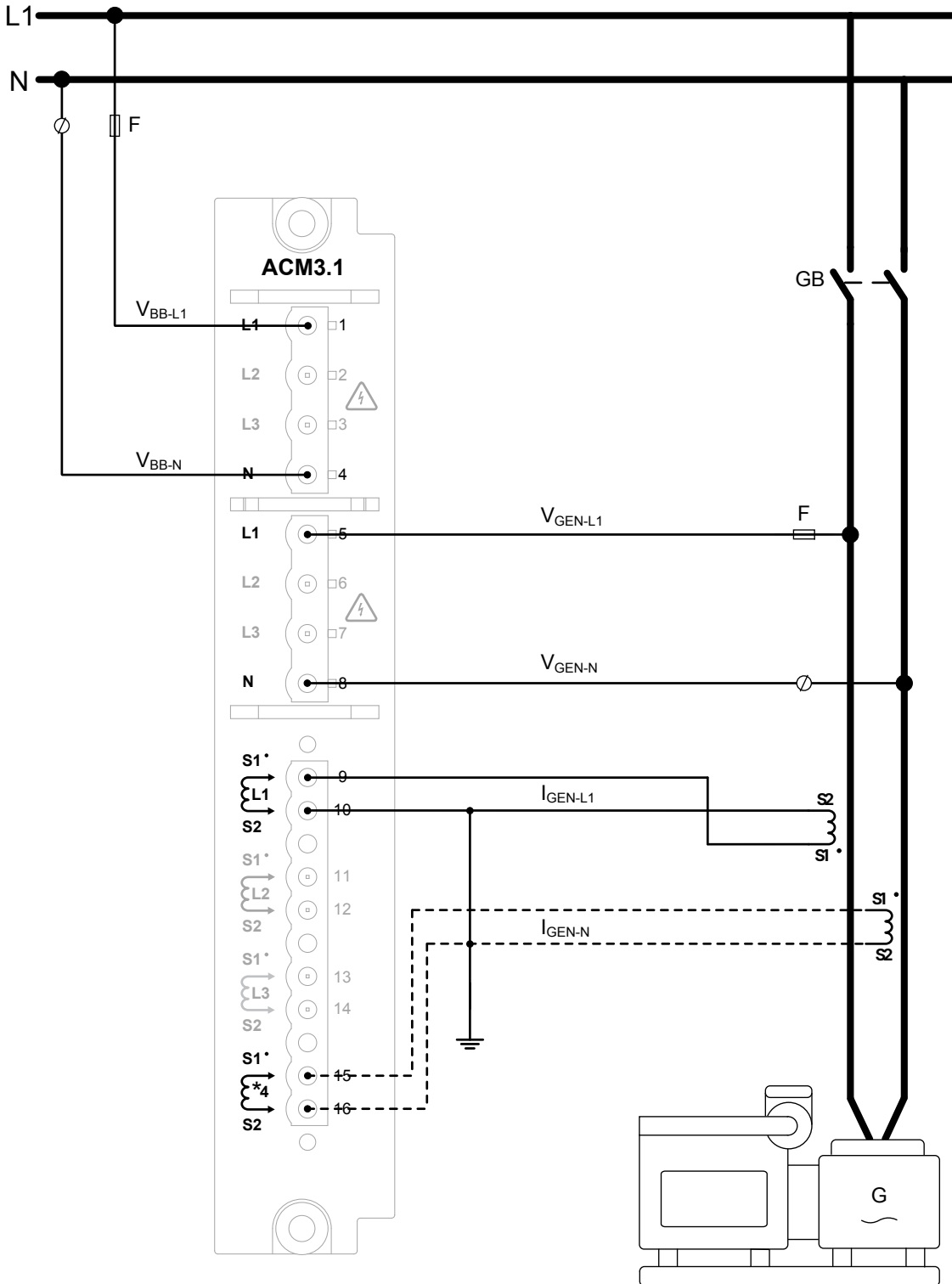

Single-phase does not mean split-phase, where the waveforms are offset by a half-cycle (180 °) from the neutral wire.

Split-phase wiring (L1-N-L2 example)

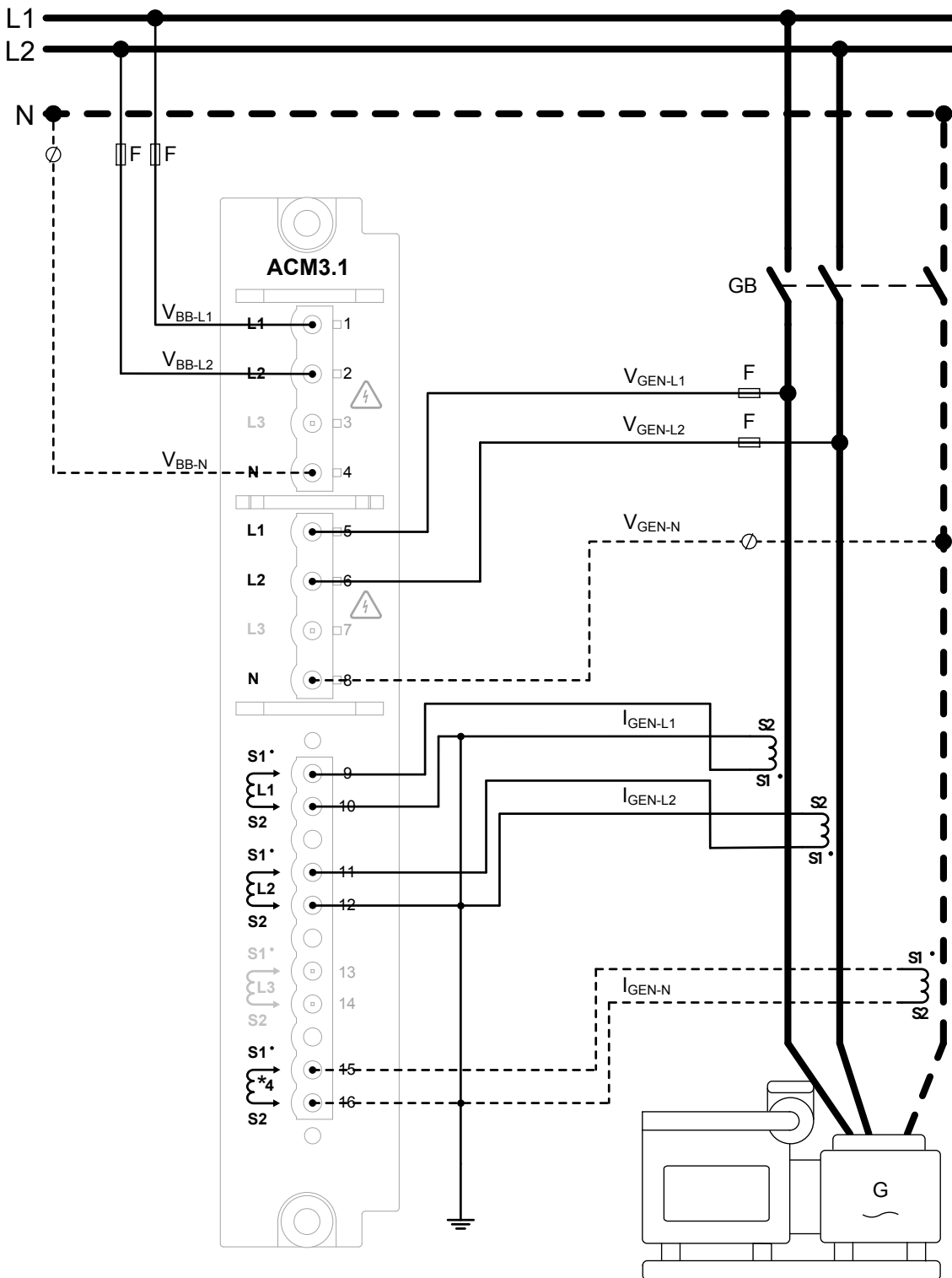

For split-phase, the waveforms are offset by a half-cycle (180 °) from the neutral wire. Split-phase is also called L1-N-L2, or single-phase in the USA.

Wiring phase-to-neutral voltage measurements

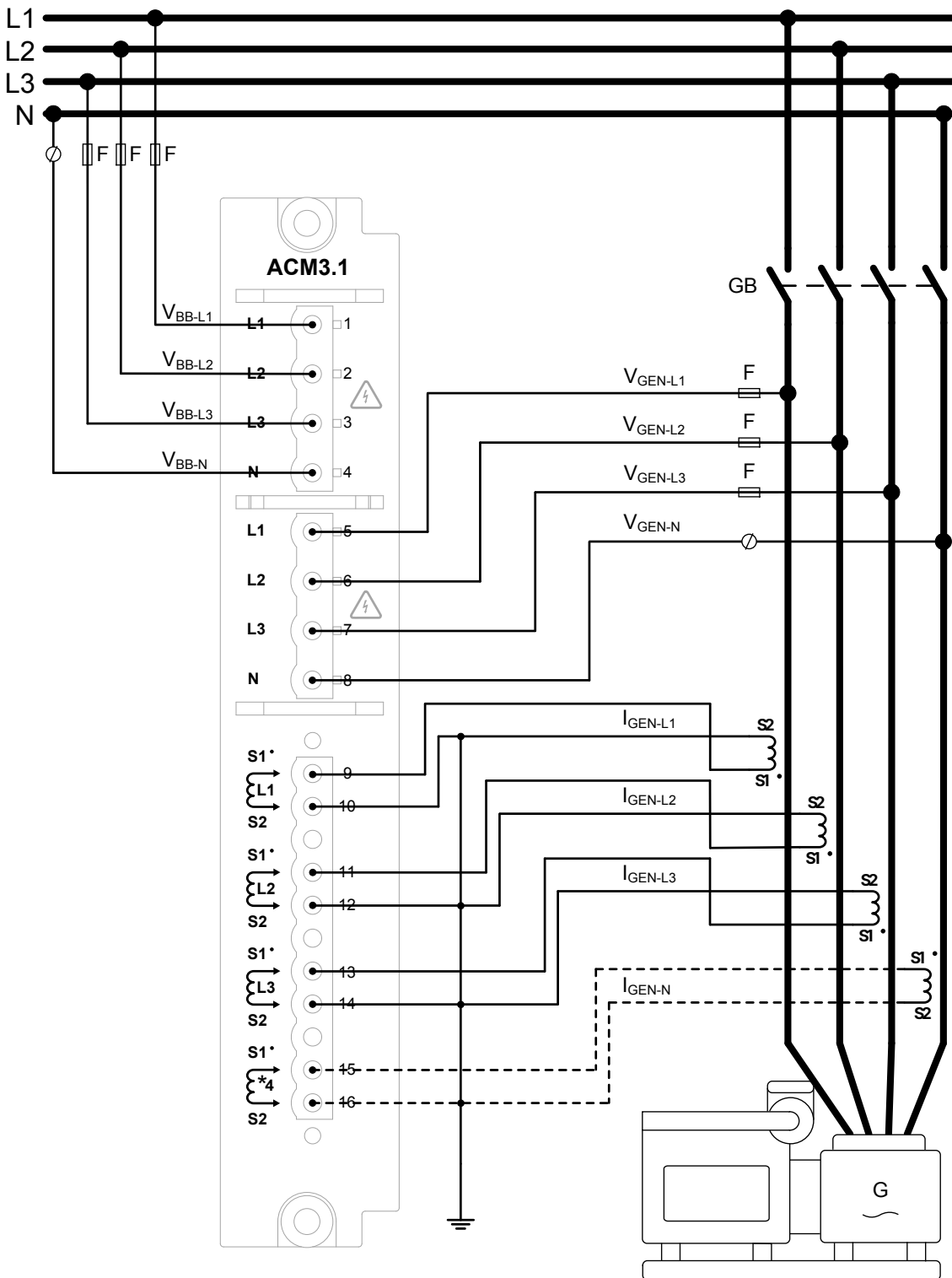

More information

See **AC configuration and nominal settings** in the **Designer's handbook** for how to set the parameters for these configurations.

4.15.2 [A-side] or [B-side] AC configuration

Example generator voltage transformer wiring

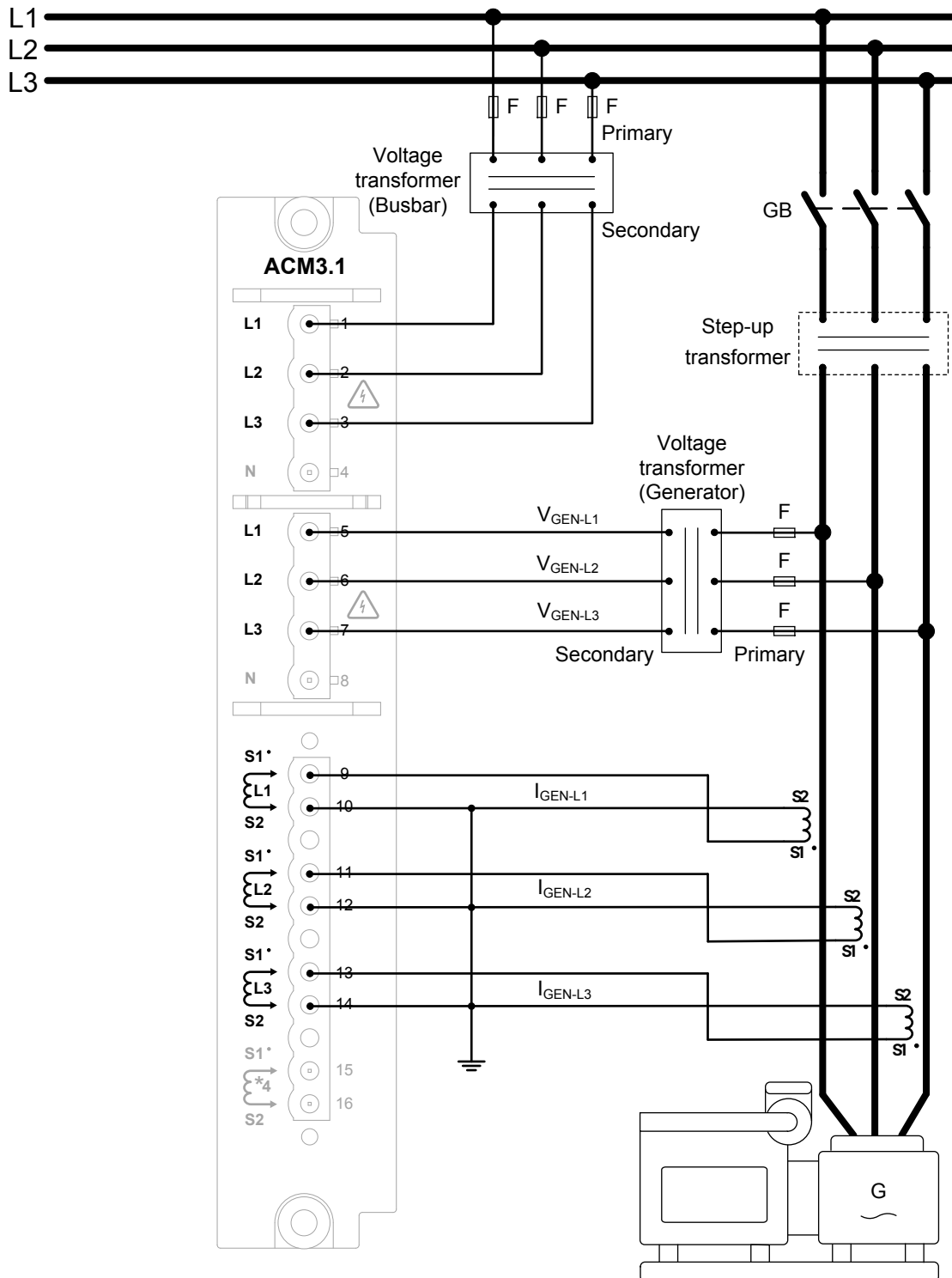

The example shows grounding on the S2 side of the current transformers. You can choose to ground the S1 side of the current transformers instead.



More information

See **AC configuration and nominal settings** in the **Designer's handbook** for how to set the parameters for this configuration.

4.15.3 Pulse breaker

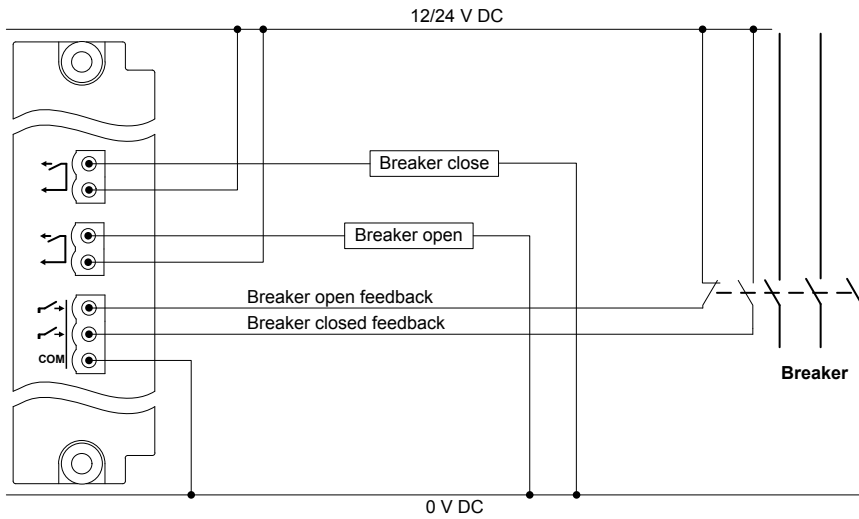

More information

See **Pulse breaker** in the **Designer's handbook** for how to set the parameters for this configuration.

4.15.4 Continuous breaker

For a continuous breaker, we recommend installing both of the breaker control relays. The *Breaker close* relay ensures precise synchronisation. The *Breaker open* relay ensures the AC protection operate times.

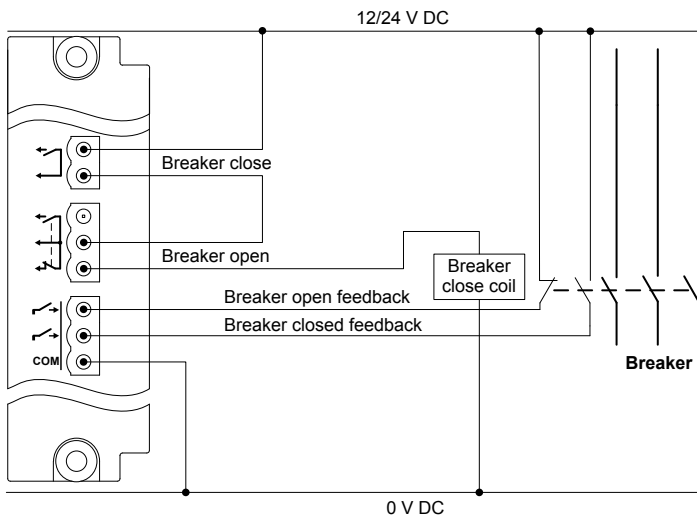

More information

See **Continuous breaker** in the **Designer's handbook** for how to set the parameters for this configuration.

4.15.5 Compact breaker

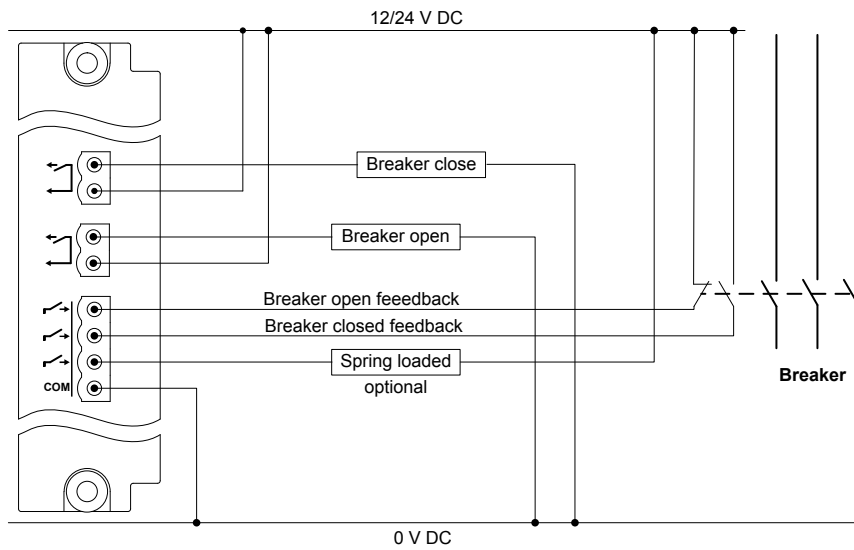

More information

See **Compact breaker** in the **Designer's handbook** for how to set the parameters for this configuration.

4.15.6 External breaker

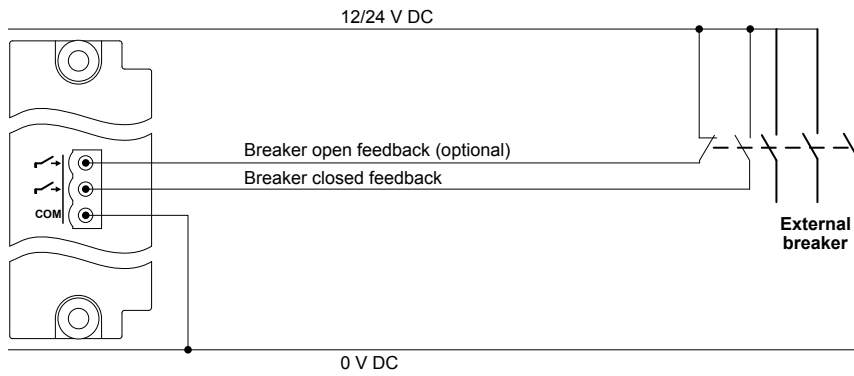

More information

See **Busbar sections and load sharing** in the **Designer's handbook** for information about busbar sections.

4.15.7 Redundant breaker feedback

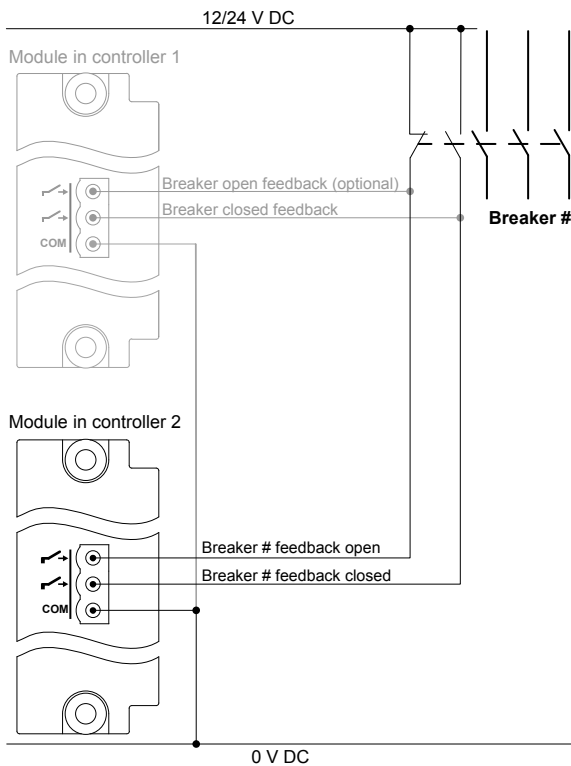

More information

See **Redundant breaker feedback** in the **Designer's handbook** for how to set the parameters for this configuration.

4.15.8 Regulation : Current output for voltage regulation

You can use a current output and one or more resistors for voltage regulation. That is, you can connect the current output from the controller to a governor or AVR that requires a voltage input. If the controller signal is lost, the regulator returns to the midpoint. This makes the system more robust.

There is no standard governor voltage range, and the documentation for governors is often poor or absent. For that reason, potentiometers are often used to ensure the correct voltage range.

We recommend field testing the regulator, to ensure that the performance is as required.

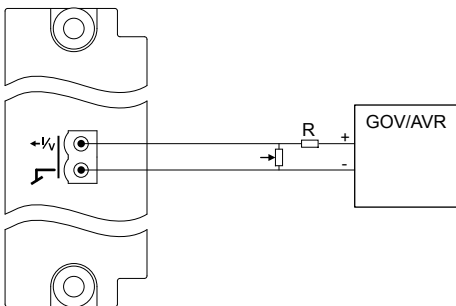

Typical value for the resistor is 2.5 k Ω , while the potentiometer is 5 k Ω .

You do not have to use a current output for voltage regulation. You can configure and connect an available voltage output directly instead. However, if the controller loses power, the output is an open circuit with infinite resistance.

4.15.9 Power management : Heavy consumer wiring

Heavy consumer with fixed feedback

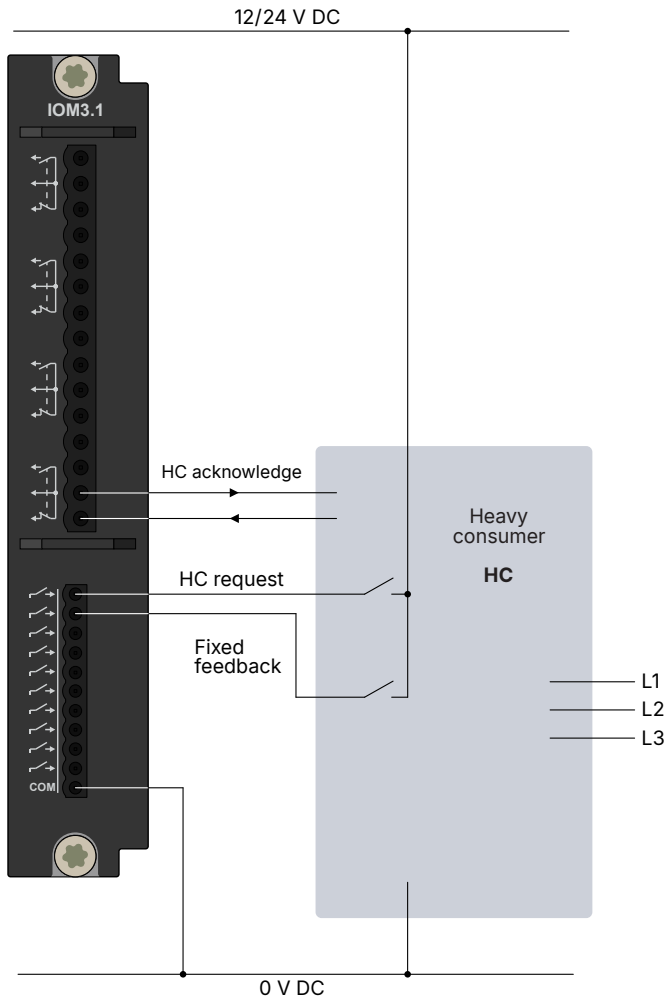

Heavy consumer with variable feedback *

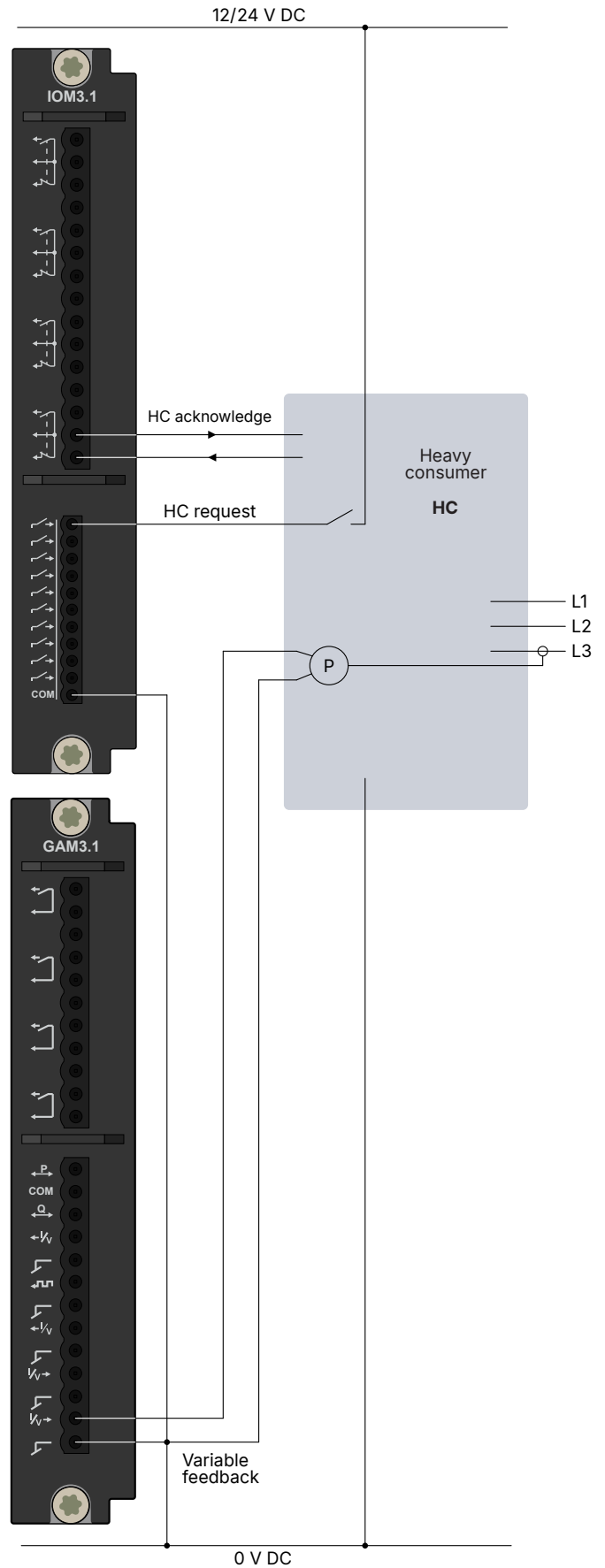

NOTE * The variable feedback requires an analogue input, for example 4 to 20 mA. This could be any module which has an available Analogue input that you can configure.

The example wiring for Heavy consumers can be reconfigured to other terminals or hardware if needed.



More information

See **Heavy consumer function** in the **Designer's handbook** for the parameters.

4.16 Display

4.16.1 iE 7 display Power supply

Connect the power supply (+) to the 12 or 24 V DC power supply, and the power supply (-) to the 0 V DC power supply.

Display

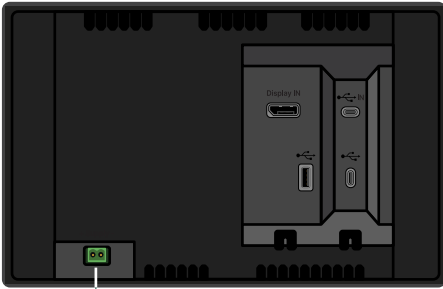

Power supply

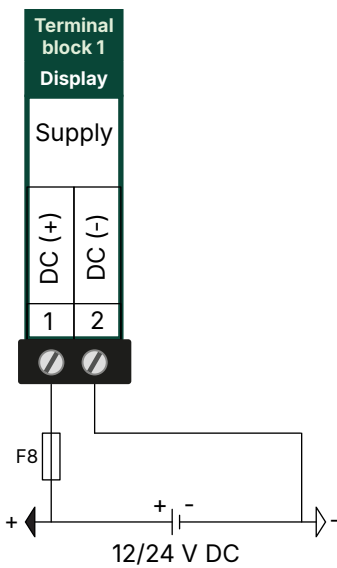

Fuse

- F7: 2 A DC max. time-delay fuse/MCB, c-curve

NOTICE



Nominal auxiliary voltage is 12 or 24 V DC (8 to 36 V DC operating range).

For F7, if voltage drops are likely, a 4 A time-delay fuse may be needed.

NOTICE

Negative power supply terminal



In marine applications, do not wire the negative power supply terminal of the modules with independent power supplies to the ship single-phase ground. If the voltage between the power supply terminals and frame ground exceeds 36 V, the power supply terminals and the frame ground terminal will be damaged.

The negative power supply terminal on the iE 7 display, must be connected to the negative power supply terminal on the controller power supply, to make an equipotential bonding conduction. See [PSM Power supply wiring](#).

4.16.2 iE 7 display connections

The display has inputs for **DisplayPort IN** and **USB type C IN**. It also has additional USB communication ports for future use.

The **DisplayPort IN** and **USB type C IN** are needed to connect and operate to the base-mounted controller.

Controller

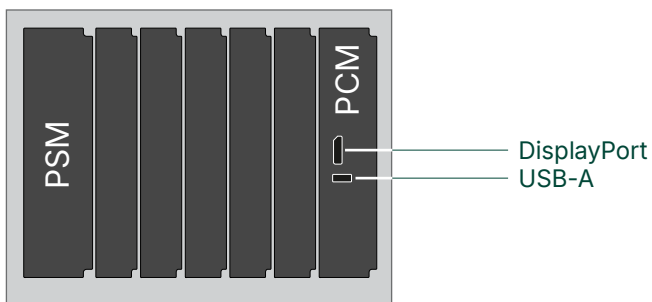

Display

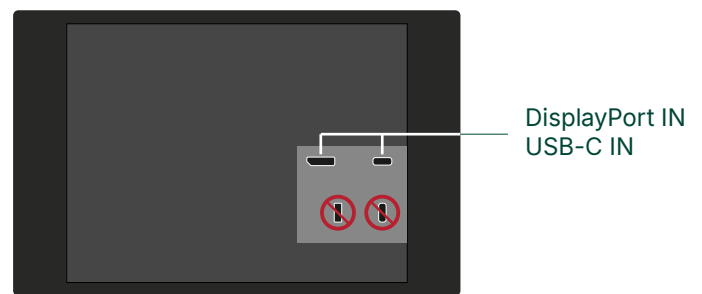

The additional USB ports on the display are for future use.

Connection constraints

- The display is only for use with a base-mounted controller.
- The **DisplayPort IN** and **USB type C IN** cables must be connected to operate the base-mounted controller.
- Controllers must be connected directly without a USB hub or similar.
- All USBs support 2.0.
- Both the DisplayPort and USB A to C cables are supplied.
- Connection to the display must use the ports marked **IN**.

Base-mounted controller to display connection

Controller

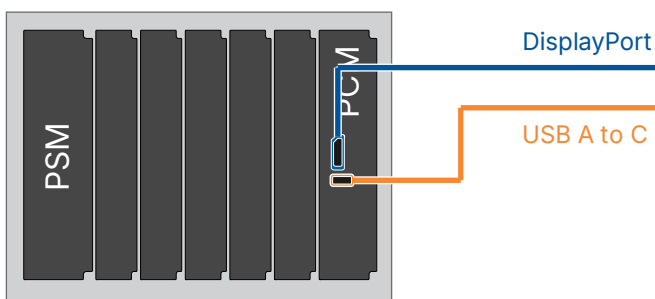

Display

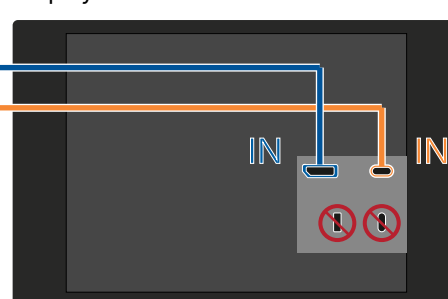

USB Connection to display must use USB IN.

5. Maintenance

5.1 Precautions before maintenance

NOTICE



Correct handling of modules

Failure to follow these instructions could lead to damage to the modules.
Read and follow the instructions to avoid damage to the modules.

NOTICE



Changing modules with maritime approvals

If you replace a hardware module with a different type, the controller loses its maritime classification societies' approvals.

Replacing with a module of the same type will not affect maritime classification societies' approvals.

NOTICE



Changing module order

If you rearrange the order of the hardware modules, you will lose the modules' configuration.
Always make a backup before changing hardware modules.

5.2 Personnel and equipment protection



DANGER!



Hazardous live currents and voltages

Hazardous live currents and voltages may be present in an installed rack. Contact with these could kill you. Only authorised personnel, who understand the precautions needed and the risks involved in working with live electrical equipment, may do this work.



CAUTION



Disrupting control

Working on the rack may disrupt the control of the generator, busbar or connection. Take the necessary precautions.



CAUTION



Protecting equipment: No hot swapping

Disconnect all power supplies before replacing any modules or the PCM battery.

NOTICE

Electrostatic discharge



During manufacturing and testing, the products have been kept in static shielding bags, and all personnel handling the products have been protected against static electricity and the subsequent ESD (electrostatic discharge).

Be sure to carry a connection to earth when handling our PCBs.

NOTICE



Torque damage to equipment

Do not use power tools during the installation/replacement. Too much torque damages the equipment.

Follow the instructions for the correct amount of torque to apply.

5.3 Rack slot requirements

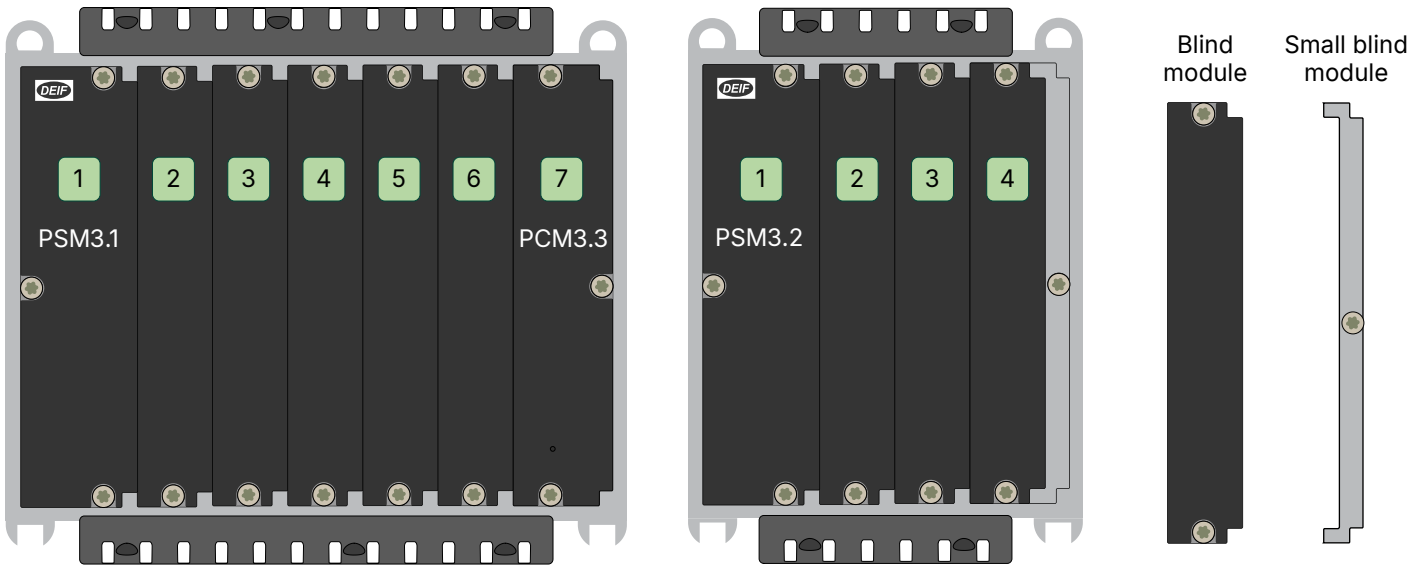

Modules can be installed in either rack R7.1 (7 slots) or R4.1 (4 slots). The modules can be arranged in any order in the rack, but must comply with these requirements.

R7.1 (7 slots)		R4.1 (4 slots)	
Controllers	Extension racks	Controllers	Extension racks
Slot 1 must have the PSM3.1 .	Slot 1 must have the PSM3.2 .	Slot 1 must have the PSM3.1 .	Slot 1 must have the PSM3.2 .
Slot 7 must have the PCM3.3 .	Other modules can be used in slot 7 but must have the small blind module .	Slot 4 must have the PCM3.3 .	Other modules can be used in slot 4 but must have the small blind module .

Blind modules (blank faceplates) must be installed over empty slots to protect the rack.

Order of the modules

All other hardware modules must installed from left to right from slot 2 onwards without empty slots between modules.

There can only be adjacent empty slots between the last module and the **PCM3.3** or end of the rack.

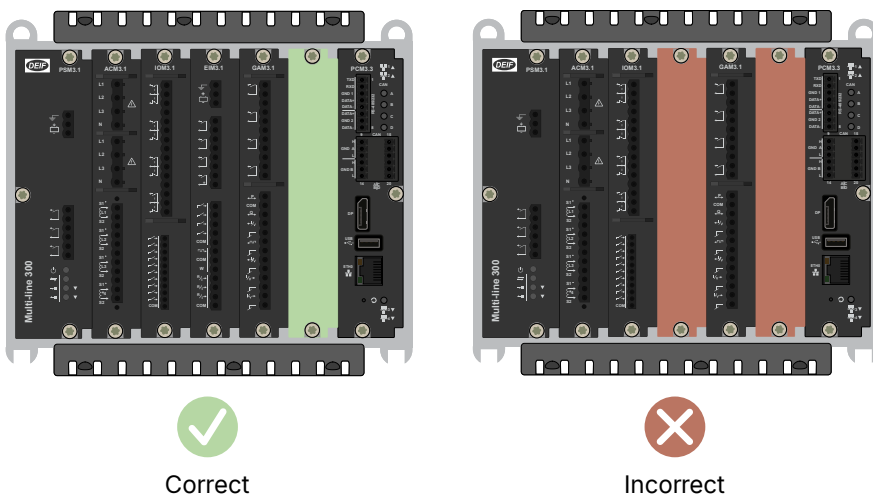

If slots are empty between the hardware modules, the modules after the empty slot(s) **cannot communicate** with the **PCM3.3** module.

5.4 Change hardware modules

Each module is fastened to the rack with TX20 screws.

These should be loosened before the extraction handles are used to lift the module free of the rack.

They do not remove completely from the hardware module.

Hold the module by the faceplate. Do **not** touch the PCB.



More information

See [Maintenance](#) for how to change the PCM battery.

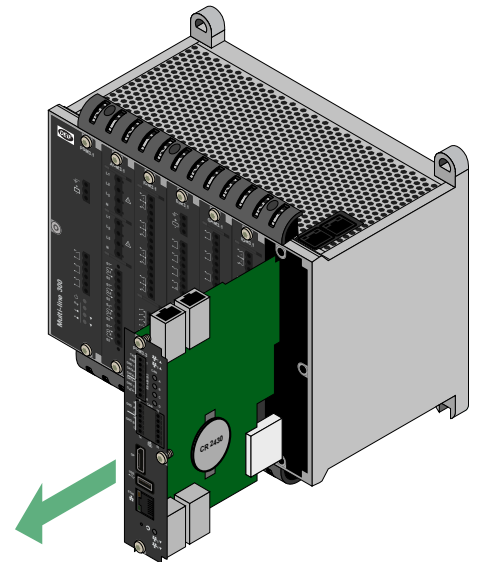

5.4.1 No hot swapping modules



DANGER!

Do not hot swap modules



It is not allowed to hot swap any modules. Hot swapping modules can be extremely dangerous to both personnel and the equipment.

Make sure the system is shutdown and power supply has been isolated and switched off.



Isolate the power supply.



Protect the modules against static discharge.



Do not alter state during installation.



Avoid touching the PCB or terminal pins.



More information

See [Warnings and safety](#) for full details of all precautions to take during installation.

5.4.2 Remove hardware modules

1.  Protect the hardware modules against static discharge.



It is recommended to use a wrist strap connection to protect against Electrostatic discharge (ESD).

Test the resistance of the wrist strap and the wrist strap connection. **Do not continue** if the wrist strap connection is faulty. Use the wrist strap at all times while installing or uninstalling any modules.

2.  The controller **must not be powered**.

Disconnect all power supplies to protect the hardware modules and personnel.

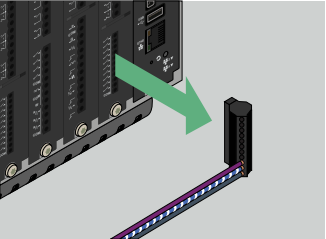
3.  Remove all terminal blocks, and make sure that there are no wires in the way of removing the hardware module.

For PSM or PCM modules, disconnect any Ethernet cables from the top and bottom.

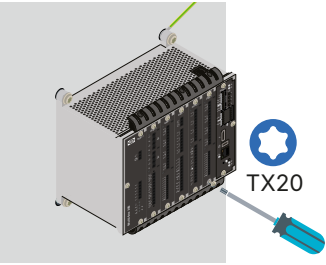
4.  Loosen the module faceplate screws with a TX20 screwdriver.

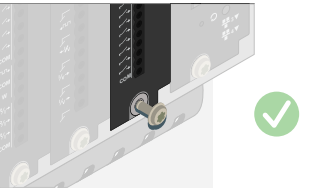
5.  Do not force the screws to unscrew completely.

The screws are built-in and should remain attached to the faceplate.

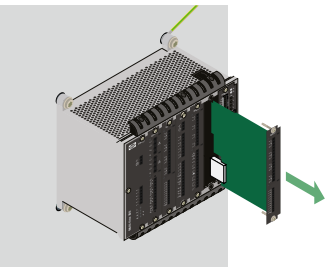
6.  Use pliers or your fingers to pull the faceplate screws, and carefully slide the hardware module out of the rack.

7.

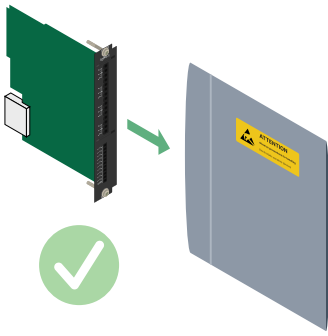

Hold the module by the faceplate.

Do **not** touch the PCB.

Put the hardware module in an ESD protective package when not installed in the rack.

5.4.3 Mount hardware modules

1. Protect the hardware modules against static discharge.



It is recommended to use a wrist strap connection to protect against Electrostatic discharge (ESD).

Test the resistance of the wrist strap and the wrist strap connection. **Do not continue** if the wrist strap connection is faulty. Use the wrist strap at all times while installing or uninstalling any modules.

2. The controller **must not be powered**.



Disconnect all power supplies to protect the hardware modules and personnel.

3. Open the ESD protective package, and remove the new module, hold it only by the faceplate.

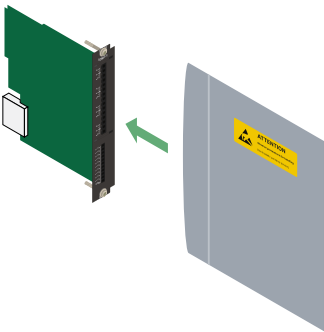

4. Slide the module into the correct slot (it should slide in easily).

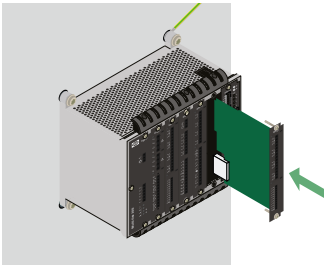

5. Tighten the screws on the module faceplate with a TX20 screwdriver.

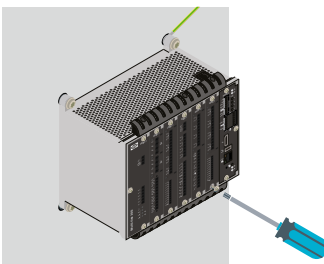

Do not exceed the recommended torque of 0.5 N·m (4.4 lb-in).

6.

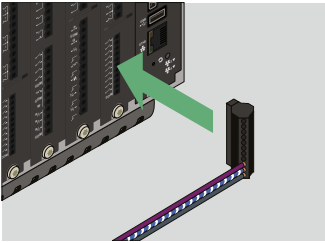

Replace all terminal blocks.

For PSM or PCM modules, replace any Ethernet cables to the top and bottom.

7.



If the rack is not mounted, return the rack to its protective packaging.

5.5 Replace RTC battery

5.5.1 Location of RTC battery on PCM3.3 module

The **PCM3.3** has a lithium battery for maintaining the real-time clock, when no power is applied.

A battery failure alarm is activated, when the battery power is low.

To replace the battery, you need to remove the PCM module.

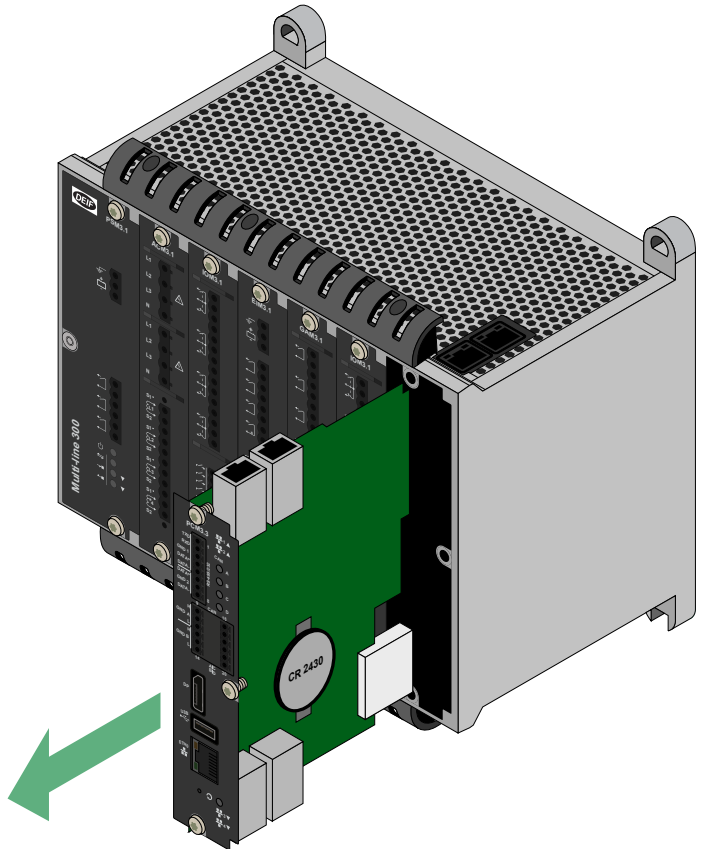

The battery is a CR2430 3V battery, rated for operation at -40 to 85 °C (-40 to 185 °F).

This is **not** a standard CR2430 battery.

Location of the battery on module

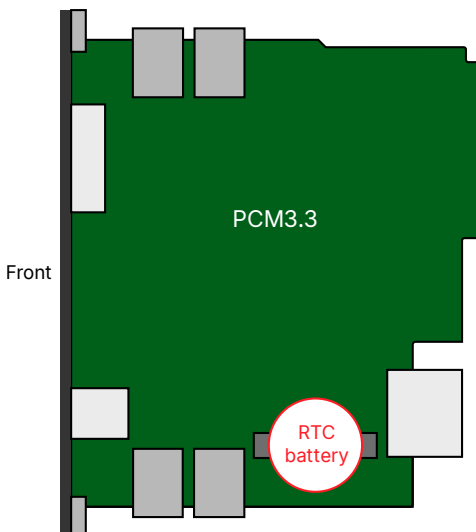

5.5.2 How to replace the RTC battery

1. Protect the hardware modules against static discharge.



It is recommended to use a wrist strap connection to protect against Electrostatic discharge (ESD).

Test the resistance of the wrist strap and the wrist strap connection. **Do not continue** if the wrist strap connection is faulty. Use the wrist strap at all times while installing or uninstalling any modules.



The controller **must not be powered**.

Disconnect all power supplies to protect the hardware modules and personnel.

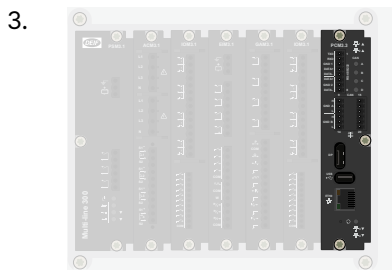

Locate the **PCM3.3** hardware module in the rack.

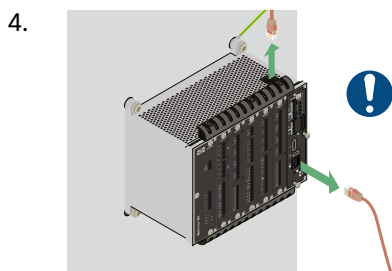

Remove all terminal blocks, and any Ethernet cables from the top and bottom.

Make sure that there are no wires in the way of removing the hardware module.

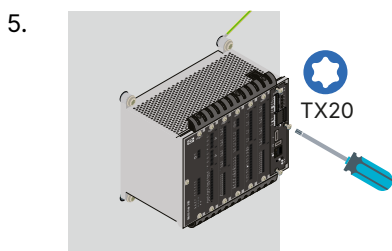

Loosen the module faceplate screws with a TX20 screwdriver.

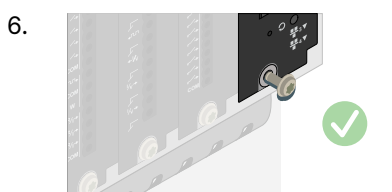

Do not force the screws to unscrew completely.

The screws are built-in and should remain attached to the faceplate.

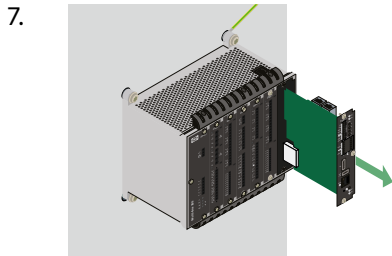

Use pliers or your fingers to pull the faceplate screws, and carefully slide the hardware module out of the rack.

Hold the module by the faceplate.

Do **not** touch the PCB.

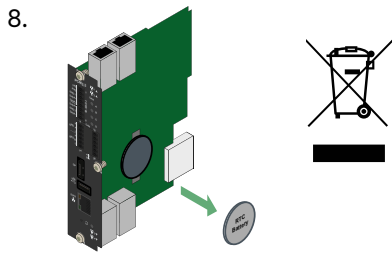

Carefully remove the old battery from the holder.

The old battery must be recycled or disposed of according to local laws and/or regulations.

 See [Disposal of waste electrical and electronic equipment](#).

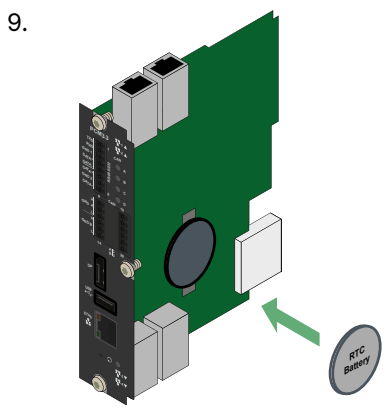

Make sure the polarity is correct.

Insert the new battery in the holder.

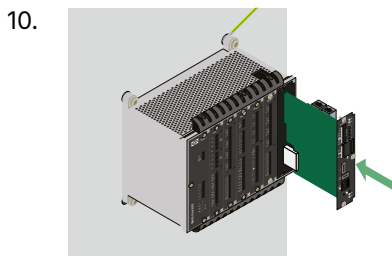

Make sure that the hardware module is the right way up.

Slide the hardware module back into the rack (it should slide in easily).

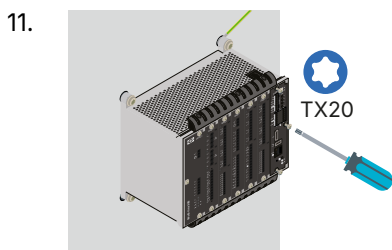

Tighten the module faceplate screws with a TX20 screwdriver.

Do not exceed the recommended torque of 0.5 N·m (4.4 lb-in).

12.

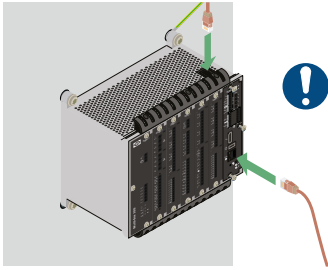

Replace all terminal blocks, and any Ethernet cables at the top and bottom.

13.



You can now recommission the controller for operation.

NOTICE

Date and time settings



After the battery is replaced, check that the date and time settings are correct. If the controller was already part of an existing system, then it will automatically adjust the date and time settings to the NTP/clock master. If the controller is not part of a system or is a stand-alone controller you must set the date and time settings.

You can use PICUS or the display to enter the correct date and time settings.

6. iE 350 as a marine safety system

In a marine application, when the controller is used as a safety system, its power supplies must have a backup supply installed.

6.1 Fast over-current protection (ANSI 50/50TD)

6.1.1 About the safety system for ANSI 50/50TD

The current measurement for the fast over-current protection (ANSI 50/50TD) is based on the highest value of all 3-phase current true RMS values. The safety approval for the primary short circuit protection only applies when you follow the installation and setup requirements in this chapter.

This setup for the safety system for short-circuit protection can be used when accepted by the local class approval society.

6.1.2 Current transformer requirements

When the controller is used as a safety system, the secondary side of the current transformer must have a nominal rating of 1 A. Configure this under:

```
[Equipment] > AC setup > Current transformer
```

You can use a current transformer with a nominal rating of 5 A on the secondary side in other applications.

6.1.3 Power supply requirements

When the controller is used as a safety system, its power supplies must have a backup supply installed.

6.1.4 Function requirements

When the controller is used as a safety system, the functions listed in the table below must be wired and configured to the indicated modules. The breaker control must be configured to a normally open relay.

6.1.5 Parameter requirements

Current transformer

The *Secondary* current transformer parameter must be configured to 1 A on the controllers in a safety system. Configure the parameter under:

```
Generator > AC setup > Current transformer
```

Range and default configuration for the secondary current transformer

Parameter	Range	Default
Secondary	1 A or 5 A	1 A

Fast over-current

Enable at least one of the fast over-current protections on the controllers in a safety system. Enable the protections under:

```
Generator > Current protections > Fast over-current # > Enable
```

Where # is 1 or 2.

Range and default configuration for the fast over-current protections

Parameter	Range	Fast over-current 1	Fast over-current 2
Set point	80 to 350 % of nominal current	200 %	300 %
Delay	0.00 s to 1 h	0.00 s	0.00 s
Enable	Not enabled, Enabled	Not enabled *	Not enabled *
Latch	Not enabled, Enabled	Enabled	Enabled
Action		Trip [Breaker]	Trip [Breaker]

NOTE * At least one of the **Fast over-current** protections must be enabled.

7. End-of-life

7.1 Disposal of waste electrical and electronic equipment

WEEE symbol

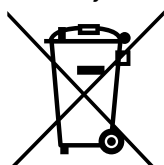

All products that are marked with the crossed-out wheeled bin (the WEEE symbol) are electrical and electronic equipment (EEE). EEE contains materials, components and substances that can be dangerous and harmful to people's health and to the environment. Waste electrical and electronic equipment (WEEE) must therefore be disposed of properly. In the EU, the disposal of WEEE is governed by the WEEE directive issued by the European Parliament. DEIF complies with this directive.

You must not dispose of WEEE as unsorted municipal waste. Instead, WEEE must be collected separately, to minimise the load on the environment, and to improve the opportunities to recycle, reuse and/or recover the WEEE. In the EU, local governments are responsible for facilities to receive WEEE. If you need more information on how to dispose of DEIF WEEE, please contact DEIF.