

# iE 350 Marine

Intelligent energy controller

Data sheet

4921240657-J



Improve  
Tomorrow

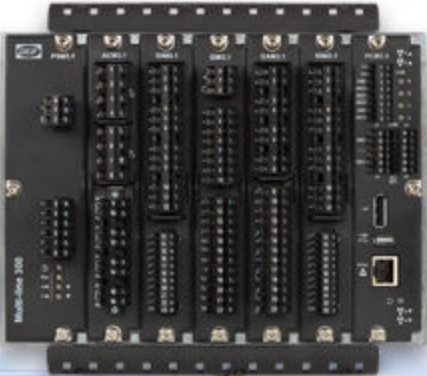

# 1. Intelligent energy controller

<b>1.1 About the controller</b> .....	<b>4</b>
1.1.1 Licences and supported features.....	4
1.1.2 About the controller types.....	4
1.1.3 About the hardware modules.....	4
1.1.4 Software versions.....	5
1.1.5 Display layout.....	6
1.1.6 Emulation.....	6
<b>1.2 Functions and features</b> .....	<b>7</b>
1.2.1 Software licences.....	7
1.2.2 General functions and features.....	7
<b>1.3 Alarms and protections</b> .....	<b>14</b>
1.3.1 Alternating current (AC) protections.....	14
<b>1.4 Applications</b> .....	<b>18</b>
1.4.1 Applications.....	18
1.4.2 Extension rack functions.....	19
<b>1.5 Compatible products</b> .....	<b>19</b>
1.5.1 DEIF digital voltage controllers (DVC).....	19
1.5.2 Additional inputs and outputs.....	20
1.5.3 Other equipment.....	21

# 2. Technical specifications

<b>2.1 Dimensions</b> .....	<b>22</b>
2.1.1 iE 7 display.....	22
2.1.2 Rack R4.1.....	23
2.1.3 Rack R7.1.....	24
<b>2.2 Mechanical specifications</b> .....	<b>25</b>
2.2.1 iE 7 display.....	25
2.2.2 Rack R7.1 or R4.1.....	25
<b>2.3 Environmental specifications</b> .....	<b>27</b>
2.3.1 iE 7 display.....	27
2.3.2 Rack R4.1 and R7.1.....	27
<b>2.4 Hardware modules</b> .....	<b>28</b>
2.4.1 Power supply module PSM3.1 (Controller).....	28
2.4.2 Power supply module PSM3.2 (Extension).....	29
2.4.3 Alternating current module ACM3.1.....	31
2.4.4 Differential current module ACM3.2.....	32
2.4.5 Engine interface module EIM3.1.....	34
2.4.6 Governor and AVR module GAM3.1.....	37
2.4.7 Governor and AVR module GAM3.2.....	39
2.4.8 Input/output module IOM3.1.....	41
2.4.9 Input/output module IOM3.2.....	42
2.4.10 Input/output module IOM3.3.....	44
2.4.11 Input/output module IOM3.4.....	46
2.4.12 Processor and communication module PCM3.3.....	48
2.4.13 Blind module.....	49
2.4.14 Small blind module.....	49
<b>2.5 Controller or extension racks</b> .....	<b>50</b>
2.5.1 Rack R4.1.....	50
2.5.2 Rack R7.1.....	50

<b>2.6 iE 7 display</b> .....	<b>51</b>
2.6.1 Terminal connections.....	51
2.6.2 Electrical specifications.....	51
2.6.3 Communication specifications.....	51
<b>2.7 Accessories</b> .....	<b>53</b>
2.7.1 USB type A to C cable.....	53
2.7.2 DisplayPort cable.....	53
2.7.3 Ethernet cable.....	53
<b>2.8 Approvals</b> .....	<b>53</b>
<b>2.9 Cybersecurity</b> .....	<b>54</b>
<b>3. Legal information</b>	
<b>3.1 Disclaimer and copyright</b> .....	<b>55</b>

# 1. Intelligent energy controller

## 1.1 About the controller

### 1.1.1 Licences and supported features

The supported features shown in this document depend on the software licence installed.

The standard license is the **Core** licence including synchronising and load share, and support. Alternatively, you can select the **Power management** licence, which includes power management features and support.



#### Example

Controllers with the Power management licence can be included in a power management system. A power management system can include a number of controllers. The controllers work together to ensure effective power management. This can include load-dependent start and stop, and may include setting the genset priority order, managing heavy consumers, and, if necessary, tripping non-essential loads.

### 1.1.2 About the controller types

The iE 350 is a versatile and modular-designed controller for marine. Its design enables you to tailor the installation to your needs.

Available hardware versions:

- **iE 350 Marine (Base)**: Base-mounted version for DIN rail or fixed (180° rotated) mounting in back panel.

An extensive range of control, protection and supervision features. Applications range from generator control and protection to engineered power management solutions.

The supported features depend on the software licence installed.

Each controller is assigned a type from the factory. You can see the type of controller on the single-line application drawing.

Controller type	Controls and protects
Genset controller	A prime mover, generator, and generator breaker.
Emergency genset controller *	An emergency prime mover, generator, and both generator breaker and busbar tie breaker. There can only be 1 Emergency generator controller in each system.
Hybrid controller	An inverter with power source, and breaker.
Bus tie breaker controller	A bus tie breaker.
Shaft generator controller	The system when a shaft generator is connected.
Shore connection controller	The system and a shore connection breaker, when a shore connection is connected.

**NOTE** \* Emergency genset controllers are only available with the Power management licence.

### 1.1.3 About the hardware modules

The hardware modules are printed circuit boards that slot in to either a rack R7.1 or rack R4.1. Depending on the type of module, they can provide AC or other measurements, inputs, outputs and give communication indication.

Example rack R7.1

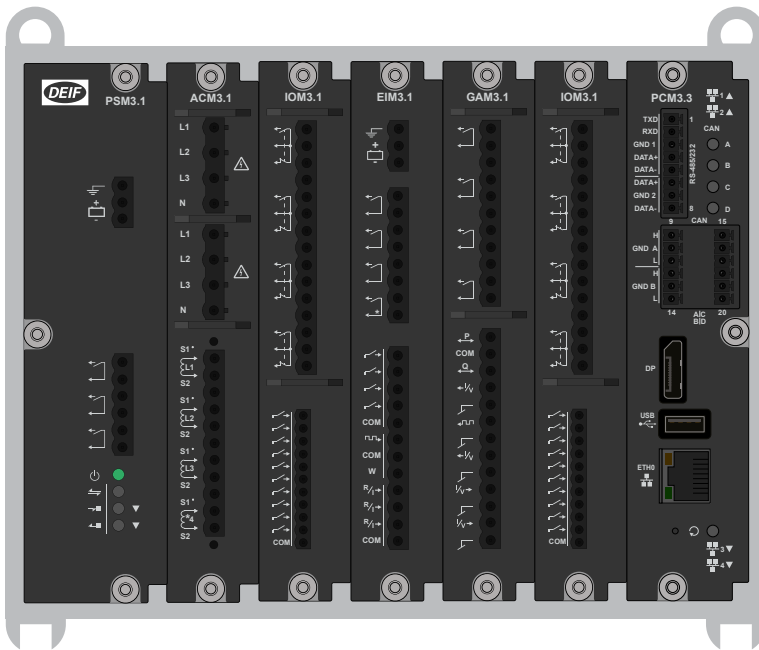

Example rack R4.1

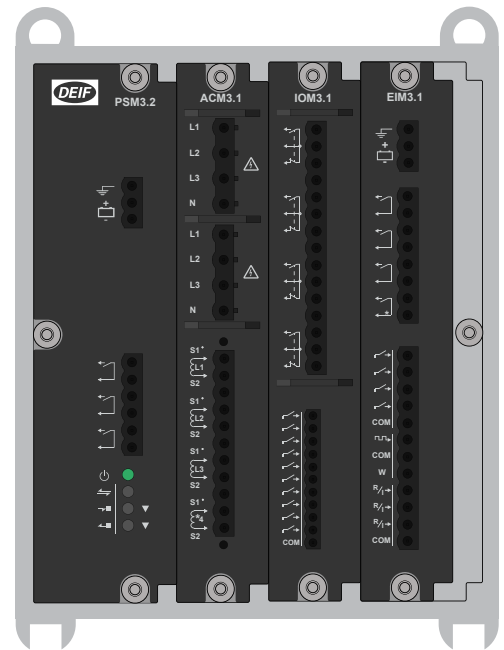

The hardware modules feature:

- Placement flexibility in the rack.
- Add, replace, or remove on-site.
- Automatically recognised.
- Configurable input and output functions (digital and analogue):
  - Digital input functions: Commands from operators or 3rd party equipment, changing configuration, operating information.
  - Digital output functions: Alarm status, commands to 3rd party equipment, operating information.
  - Analogue input functions: External set points, operating information, supervised binary inputs.
  - Analogue output functions: Regulation \*, operating information.

**NOTE** \* Only available on certain types of controller.

All slots must be covered during operation and blind modules can be used to cover unused slots.

### 1.1.4 Software versions





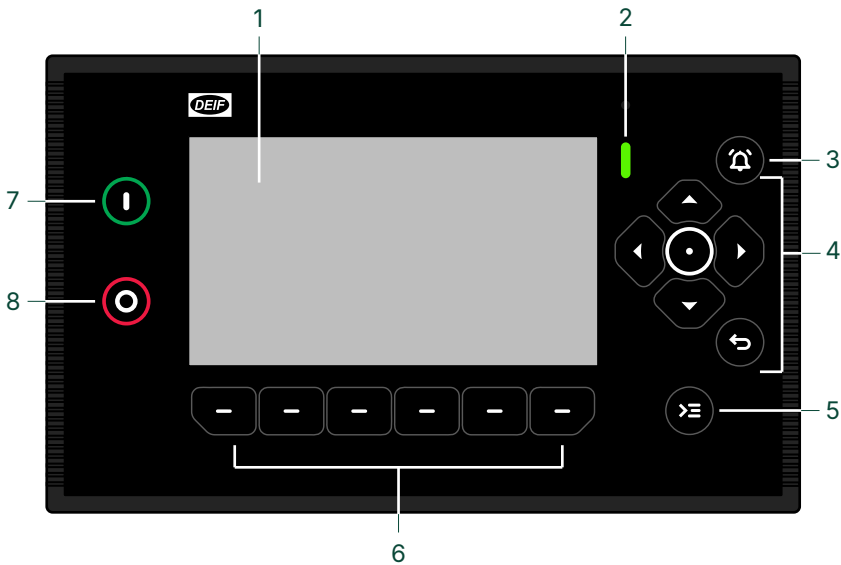

The information in this document relates to software versions:

Software	Details	Version
iE 350 Marine Core iE 350 Marine Power management	Controller application	2.0.11.x
CODESYS libraries	CODESYS	2.0.11.x
PICUS	PC software	1.0.24.x

## 1.1.5 Display layout

The base-mounted controller can run with or without a display, but we recommend that you use an iE 7 display. The display is the operator's interface to the controller.



No.	Item	Notes
1	Display screen	7" colour touch screen.
2	Status LED	Multi-colour LED for status indication.
3	 Notification centre button	Silences the alarm horn (deactivates the output), and opens the <b>Notification centre</b> , which shows alarms and events.
4	Navigation buttons	Up, down, left, and right arrows.
	 Enter button	Confirms the selection.
	 Back button	<ul style="list-style-type: none"> <li>Returns to the previous page</li> <li>Shows the menu.</li> <li>Hold: Change to Dashboard</li> </ul>
5	 Control centre button	Opens the <b>Control centre</b> .
6	Configurable buttons	Buttons can be activated either by pressing the physical button or the soft key on the screen. *
7	 Start button	In manual or local operation, it starts the asset.
8	 Stop button **	In manual or local operation, it stops the asset.

**NOTE** \* Dashboard pages can be created, copied and modified, to assign different functions to the buttons (with PICUS and the Display designer).

\*\* Double press to override cooldown process. Press again to cancel **Idle run**, if configured. Idle run may not be permitted or approved by certain maritime classification societies.

## 1.1.6 Emulation

iE 350 includes an emulation tool to verify and test the functionality of the application, for example plant modes and logic, breaker handling, shore and generator operation.

Application emulation is useful for training, customising plant requirements and for testing basic functionality that needs to be set up or verified.

## 1.2 Functions and features

### 1.2.1 Software licences

The supported features depend on the software licence installed.

The standard license is the **Core** licence synchronising and load share, and support. Alternatively, you can select the **Power management** licence, which includes power management features and support.

### 1.2.2 General functions and features

Modular and configurable design	
Mounting	<ul style="list-style-type: none"> <li>• <b>iE 350 Marine (Base)</b> Base-mounted</li> <li>• <b>iE 7 display</b> HMI display</li> </ul>
Display	<b>iE 7 display</b> <ul style="list-style-type: none"> <li>• For base-mounted</li> </ul>
New display – easy mount	Display has same cut-out footprint as the DEIF DU 300.
Easy expansion	Range of <a href="#">Series 300 modules and extension racks</a> .

Load control features	
Control modes	LOCAL (commands from display push-buttons) REMOTE (commands from digital inputs, PICUS, Modbus, CustomLogic, CODESYS)
Load control	Communication over the DEIF network Ethernet. Genset controllers can have equal load sharing. Genset controllers can do asymmetrical load sharing. Genset controllers can synchronise/de-load Mains and BTB controllers. External breaker position feedback. Automatic detection of load sharing busbar sections (including for a ring busbar).

Power management features	
Control modes	<ul style="list-style-type: none"> <li>• AUTO mode:               <ul style="list-style-type: none"> <li>◦ Automatic power management</li> <li>◦ Automatic load-dependent genset start &amp; stop</li> <li>◦ Automatic synchronisation &amp; de-loading, and breaker control</li> </ul> </li> <li>• MANUAL mode:               <ul style="list-style-type: none"> <li>◦ Operations only on operator command.</li> <li>◦ Operator-initiated synchronisation and de-loading.</li> <li>◦ Display control for genset start/stop and breaker open/close.</li> <li>◦ Display user-configured dashboard soft-key.</li> </ul> </li> </ul> Change control mode (AUTO/MANUAL) from the display, from PICUS, or via Modbus.
Power management operation	Ethernet-based power management: <ul style="list-style-type: none"> <li>• Up to a total of 32 asset controllers with breakers from:               <ul style="list-style-type: none"> <li>◦ Prime movers and generators (gensets)</li> <li>◦ Shore connections</li> <li>◦ Shaft generators</li> <li>◦ Hybrid controllers</li> </ul> </li> </ul>

## Power management features

	<ul style="list-style-type: none"> <li>◦ Bus tie breaker controllers</li> <li>• Up to 1 Emergency generator controller.</li> </ul> <p>Ethernet network redundancy is possible.</p>
<b>Reliable power</b>	<ul style="list-style-type: none"> <li>• Blackout prevention <ul style="list-style-type: none"> <li>◦ Precautionary genset/inverter start (either automatically or by operator action).</li> <li>◦ De-load before opening breakers.</li> <li>◦ Genset/inverter breaker does not open if this would cause overload or a blackout.</li> </ul> </li> <li>• Fast load-reduction.</li> <li>• Configurable recovery after blackout.</li> </ul>
<b>Load control</b>	<p>Load control between controllers up to 32 assets.</p> <ul style="list-style-type: none"> <li>• Load transfer (for synchronisation, de-loading and load sharing)</li> <li>• Load-dependent start (two sets of parameters available) <ul style="list-style-type: none"> <li>◦ For example, Normal start and Faster start (low available power)</li> <li>◦ Based on active or apparent power, or on percentage of nominal power</li> </ul> </li> <li>• Load-dependent stop (two sets of parameters available) <ul style="list-style-type: none"> <li>◦ For example, Normal stop and Faster stop (high available power)</li> <li>◦ Based on active or apparent power, or on percentage of nominal power</li> </ul> </li> <li>• Power management system calculates control set points <ul style="list-style-type: none"> <li>◦ Based on system configuration, controller modes, and load sharing.</li> <li>◦ Frequency, power, voltage, power factor and/or var</li> </ul> </li> <li>• External analogue inputs as control set points.</li> </ul> <p>Generator controllers can connect or disconnect Heavy consumers (HC).  Generator controllers can connect or disconnect Non-Essential Loads (NEL).  External breaker position feedback.  Automatic detection of load sharing busbar sections (including for a ring busbar).</p>
<b>Priority selection</b>	<ul style="list-style-type: none"> <li>• Set the first priority</li> <li>• Manual <ul style="list-style-type: none"> <li>◦ Set user-configured dashboard soft-key, digital input, or Modbus</li> <li>◦ Delayed priority shift</li> </ul> </li> <li>• Last priority for genset with digital input or CustomLogic</li> <li>• Dynamic (first genset to connect has the highest priority)</li> <li>• Running hours (Total or trip counters)</li> </ul>
<b>Heavy consumer management</b>	<ul style="list-style-type: none"> <li>• Up to 6 fixed and/or variable heavy consumers per controller.</li> <li>• Pre-programmed heavy consumer management sequence (with configurable parameters)</li> <li>• Digital or analogue feedback from the heavy consumer. *</li> </ul>
<b>Busbar section management</b>	<ul style="list-style-type: none"> <li>• Configurable power management rules for each section.</li> <li>• Up to 4 externally-controlled breakers per controller * <ul style="list-style-type: none"> <li>◦ Bus tie breakers and/or shore connection breakers.</li> </ul> </li> <li>• Ring busbar.</li> </ul>
<b>Load sharing</b>	<ul style="list-style-type: none"> <li>• Active power (kW) load sharing (GOV)</li> <li>• Reactive power (kvar) sharing (AVR)</li> <li>• Load sharing between gensets: <ul style="list-style-type: none"> <li>◦ Over the DEIF network</li> </ul> </li> <li>• Load sharing options for each busbar section: <ul style="list-style-type: none"> <li>◦ Equal load sharing (symmetrical).</li> <li>◦ Asymmetric P load sharing for gensets.</li> </ul> </li> </ul>

## Power management features

	<ul style="list-style-type: none"> <li>◦ Asymmetric Q load sharing for gensets.</li> <li>◦ HYBRID inverter with asymmetric load sharing with configurable constant discharge and genset start if required.</li> <li>◦ Shaft generator base load, with asymmetric load sharing for the gensets.</li> <li>◦ Shore connection base load, with asymmetric load sharing for the gensets.</li> <li>◦ One genset base load, with asymmetric load sharing for the other gensets.</li> </ul>
<b>Additional features</b>	Generator load-dependent start and stop Asymmetrical generator load sharing Safety stop of generator Flexible application

**NOTE** \* Up to 3 externally-controlled breakers per Emergency generator controller.

\*\* For some controllers, the default hardware does not include analogue inputs. Extra hardware must be installed if analogue feedback from the heavy consumer is required.

## Application

<b>Single-line application drawing</b>	Flexible applications.
<b>Busbar</b>	Busbar can have a ring connection.
<b>Heavy consumers *</b>	Configurable feedback type and controller.
<b>Non-Essential Loads</b>	Configurable trip signal.
<b>Breakers</b>	Redundant breaker feedback on bus tie breakers. Externally controlled breakers.

**NOTE** \* Available in the Power management licence.

## AC configuration features

<b>Nominal settings</b>	4 sets of settings.
<b>AC configuration</b>	Three-phase Three-phase (2 CT, L1L3) Split-phase L1L2 Split-phase L1L3 Split-phase L2L3 Single phase L1 Single phase L2 Single phase L3
<b>4th current</b>	Measurement for earth or neutral protections.
<b>Additional features</b>	<ul style="list-style-type: none"> <li>• 100 to 690 V AC (selectable)</li> <li>• CT -/1 or -/5 (selectable)</li> </ul>

## General functions

<b>Regulation</b>	<b>Governor:</b> <ul style="list-style-type: none"> <li>• Active power load sharing</li> <li>• Fixed frequency</li> <li>• Fixed active power</li> <li>• Frequency droop</li> </ul> <b>Governor with Power management:</b>
-------------------	---

## General functions

	<ul style="list-style-type: none"> <li>• Active power load sharing</li> <li>• Frequency regulation</li> <li>• Frequency and phase synchronisation</li> <li>• Fixed power</li> </ul> <p><b>AVR:</b></p> <ul style="list-style-type: none"> <li>• Reactive power load sharing</li> <li>• Fixed voltage</li> <li>• Fixed reactive power</li> <li>• Fixed cos phi</li> <li>• Voltage droop</li> </ul> <p><b>AVR with Power management:</b></p> <ul style="list-style-type: none"> <li>• Voltage regulation</li> <li>• Reactive power load sharing</li> <li>• Fixed reactive power</li> <li>• Fixed cos phi</li> </ul> <p>Three sets of temperature-dependent power derate settings. Set point selection using digital input, Modbus, and/or CustomLogic or CODESYS. Configurable power ramp up, power ramp down</p>
<b>Pre-programmed sequences</b>	<p><b>Generator: *</b> Generator start and stop.</p> <p><b>Breaker:</b> Breaker open sequence (with and without de-loading). Breaker close sequence (with synchronisation). Blackout close. ****</p>
<b>Synchronisation</b>	<p>Automatic synchronisation and de-loading. Operator-initiated synchronisation and de-loading possible. Choose between Static or Dynamic synchronisation. ** De-load before opening.</p>
<b>Breaker control</b>	<p>Breaker types (with configurable parameters): Pulse breaker, Compact breaker, Continuous breaker. Breaker position detection and alarms. Configurable Breaker under-voltage coil setting.</p>
<b>Configurable Idle run ***</b>	<p>Protect the engine with additional warm-up or cooldown periods.</p>
<b>Advanced troubleshooting</b>	<p>Controller self-test. Event and alarm log, with real-time clock.</p>
<b>Event log</b>	<p>The controller stores a maximum of 2000 log entries. When the log is full, the controller discards the excess log entries using first in, first out.</p>
<b>User management</b>	<p>Configurable permission roles and users.</p>
<b>AC measurements</b>	<p>AC measurements can be configured with average filters for use on noisy or oscillating systems for the displayed information. Controller data and calculations are not affected. Actual values are always used for the calculations and protections. Choice of <i>No filters</i>, or <i>average over a selected time</i> (200 or 800 milliseconds).</p>
<b>CPU load overview</b>	<p><i>Currently, Average over 10 seconds. Average over 1 minute, or Average over 10 minutes.</i></p>
<b>CODESYS</b>	<p>Option: Extended controller functionality with soft PLC. CODESYS runtime.</p>

General functions	
	Custom information pop-up messages and status texts. Provide better customised user experience by delivering messaging and status information from the CODESYS application. View CODESYS license type in WebConfig.
<b>Non-essential load (NEL)</b>	Up to 3 non-essential loads per controller. Each controller can connect to the same 3 non-essential load breakers. Alarms for over-current, under-frequency, overload, and reactive overload for each non-essential load.
<b>Additional hardware/software features</b>	Power supply voltage measurement diode offset. Output configuration (function, coil state). Analogue input sensor failure (below and above range). Analogue input pre-configured curves, plus up to 20 customisable curves. Analogue output pre-configured curves, plus up to 20 customisable curves.

**NOTE** \* Generator controllers only.  
 \*\* Static synchronisation cannot be performed in non-regulating controller types where regulation is required.  
 \*\*\* Supported engines only. See the [Engine interface communication manual](#) for the supported J1939 engines and manufacturers. Idle run may not be permitted or approved by certain maritime classification societies.  
 \*\*\*\* With Power management software licence.

Display	
<b>Easy and user-friendly interface</b>	Easy control with customisable dashboards. Adaptive mimics. Configurable physical buttons. 7" colour touch screen that can be used in combination with physical buttons.
<b>Fast short-cut button</b>	Configurable shortcut feature gives the user easy access to frequently used functions.

Communication	
<b>Plug and play</b>	Automatic network configuration (uses static IPv6) Automatic date and time synchronisation between all controllers in the system NTP time synchronisation with NTP servers
<b>Redundancy</b>	Redundant Ethernet
<b>Multi-master system</b>	<ul style="list-style-type: none"> <li>• Multi-master system. All vital data is broadcast to all controllers:               <ul style="list-style-type: none"> <li>◦ Each controller performs all calculations, then acts accordingly.</li> <li>◦ Power management inputs and outputs may be connected to any controller. **</li> <li>◦ Load sharing communication</li> </ul> </li> </ul>
<b>Ethernet communication</b>	<ul style="list-style-type: none"> <li>• Secured protocols on Ethernet communication</li> <li>• Static Internet Protocol version 6 (IPv6)</li> <li>• Configurable Internet Protocol version 4 (IPv4)</li> <li>• Configurable Ethernet port settings on PCM3.3</li> <li>• Alarms for Unknown traffic and Data loss.</li> </ul>
<b>CAN bus communication</b>	4 CAN ports for: <ul style="list-style-type: none"> <li>• J1939-based ECU communication</li> <li>• Communication to Digital AVR:               <ul style="list-style-type: none"> <li>◦ DVC 350</li> <li>◦ DVC 550</li> <li>◦ Leroy Somer D550</li> </ul> </li> </ul>

## Communication

<b>RS-485 communication *</b>	2 serial ports configurable as client or server
<b>Modbus server</b>	<p>Supports multiple Modbus protocols: TCP/IP, RTU *</p> <p>Standard protocol: Modbus server, TCP/IP</p> <p>Supports use and creation of custom protocols.</p> <p>Import and export Modbus protocols.</p> <p>Convert data units and scaling.</p> <p>Configure Modbus server settings.</p>

**NOTE** \* For future use.

\*\* With Power management licence.



### More information

See the [Engine interface communication manual](#) for the supported J1939 engines and manufacturers.

## Configuration tool - PICUS

<b>General features</b>	<p>PC software to connect to one or more controllers.</p> <p>Application design (Single-line diagram) tool for creation, configuration and broadcast.</p> <p>Updated firmware for the controller and display.</p> <p>Supports multiple controller languages.</p> <p>Backup / restore projects or configurations.</p> <p>Commissioning tools.</p>
<b>Display designer</b>	<p>For creation and configuration on the display:</p> <p>Dashboard layout and widgets.</p> <p>Header design and widgets.</p>
<b>Controller configuration</b>	<p>Configure controller inputs, outputs, and parameters.</p> <p>View status and live data.</p> <p>Manage backups and restores.</p> <p>Use offline projects to view or edit a controller configuration.</p>
<b>System emulation</b>	Safely mimic the environment that the controller connects to (loads, inputs, and failure scenarios).
<b>System supervision</b>	Supervise and control the application.
<b>Alarms and log events</b>	<p>Manage alarms.</p> <p>Run alarm tests.</p> <p>View event logs and J1939 DM2 logs (if ECU enabled).</p>
<b>Input / output status</b>	See an overview for all the input and output values for the controller, extension racks, and ECU (if configured).
<b>Trending</b>	<p>Record and save operational values over a period of time.</p> <p>Export recorded trace values to a .csv file.</p>
<b>Tags</b>	Show or hide Tags for Alarm pop-up, alarms, log, parameters, and reports.
<b>Permission control</b>	Role and user management.
<b>CustomLogic</b>	<p>User-friendly logic configuration tool, based on ladder logic and function blocks.</p> <p>Selectable input events and output commands per controller.</p> <p>Inter-controller communication with each controller in the system. (For compatible controllers).</p> <p>Modbus signals (inputs and/or outputs).</p>

## WebConfig

<b>WebConfig</b>	A browser-based tool to connect to the controller IP address.
------------------	---

## WebConfig

View controller information.  
Manage cybersecurity configuration.  
If required, restart the controller or do a factory reset.

## 1.3 Alarms and protections

### 1.3.1 Alternating current (AC) protections

The controllers include the following alternating current (AC) protections, according to IEEE Std. C37.2™-2008.

The *operate time* is defined in IEC 447-05-05 (from the instant when the need for the protection arises, to when the controller output has responded). For each protection, the *operate time* is given for the minimum user-defined time delay.

All AC alarms are available on all controller types, unless noted in the alarm column.

Controller type	A-side	B-side
GENSET	Generator	Busbar
EMERGENCY *	Generator	Busbar
HYBRID	Inverter	Busbar
SHAFT generator	Generator	Busbar
SHORE connection	Shore busbar	Ship busbar
BUS TIE breaker	Busbar A	Busbar B

**NOTE** \* With the Power management licence.

#### AC protections for the A-side

Protection	Alarms	IEC symbol (IEC 60617)	ANSI (IEEE C37.2)	Operate time	Based on
Over-voltage	3	U>	59	< 100 ms	The highest phase-to-phase (or phase-to-neutral) voltage
Under-voltage	3	U<	27	< 100 ms	The lowest phase-to-phase (or phase-to-neutral) voltage
Voltage unbalance (voltage asymmetry)	1	UUB>	47	< 200 ms *	The highest difference between any of the 3 phase-to-phase (or phase-to-neutral) voltage true RMS values, and the average value
Positive sequence under-voltage	1	U <sub>1</sub> <	27D	< 60 ms ***	The estimated phase-to-neutral voltage phasors
Negative sequence voltage	1	U <sub>2</sub> >	47	< 200 ms *	The estimated phase-to-neutral voltage phasors
Zero sequence voltage	1	U <sub>0</sub>	59U <sub>0</sub>	< 200 ms *	The estimated phase-to-neutral voltage phasors
Over-current	2	3I>	50TD	< 100 ms	The highest phase current true RMS value
Fast over-current (short circuit)	2	3I>>>	50/50TD	< 50 ms	The highest phase current true RMS value
Current unbalance (average)	1	IUB>	46	< 200 ms *	The highest difference between any of the 3 phase currents and the average value
Current unbalance (nominal)	1	IUB>	46	< 200 ms *	The highest difference between any of the 3 phase currents and the nominal value

Protection	Alarms	IEC symbol (IEC 60617)	ANSI (IEEE C37.2)	Operate time	Based on
Directional over-current	2 **	$I > \rightarrow$	67	< 100 ms	The highest phase current true RMS value, with the direction from the active power
Inverse time over-current	1	$I t >$	51	-	The highest phase current true RMS value, based on IEC 60255 part 151
Negative sequence current	1	$I_2 >$	46	< 200 ms *	The estimated current phasors
Zero sequence current	1	$I_0 >$	51 $I_0$	< 200 ms *	The estimated current phasors
Over-frequency	2	$f >$	81O	< 100 ms	The lowest fundamental frequency of a phase voltage
Under-frequency	2	$f <$	81U	< 100 ms	The highest fundamental frequency of a phase voltage
Overload (power export)	3	$P >$	32	< 100 ms	The active power (all phases)
Reverse power (power import)	2 *****	$P <$	32R	< 100 ms	The active power (all phases)
Overload reverse power ****	2		32R	< 100 ms	The active power (all phases)
Over-excitation (reactive power export)	2	$Q >$	40O	< 100 ms	The reactive power (all phases)
Under-excitation (reactive power import/loss of excitation)	2	$Q <$	40U	< 100 ms	The reactive power (all phases)
Stabilized differential current protection (ACM3.2 differential current module required)	1	$I_d >$	87G	< 40 ms (when the measured value increases from zero to two times the alarm set point)	<p>The RMS value of the fundamental frequency part of the sum/difference of the neutral side and consumer side currents, dependent on the operating characteristic</p> <p>Operate value accuracy: Based on the largest secondary current</p> <ul style="list-style-type: none"> <li><math>I_{\text{secondary}} \leq 20 \text{ A}</math>: 1.5 % of <math>I_{\text{secondary}}</math> or <math>\pm 15 \text{ mA}</math></li> <li><math>20 \text{ A} &lt; I_{\text{secondary}} \leq 250 \text{ A}</math>: 2.5 % of <math>I_{\text{secondary}}</math></li> </ul>
High set differential current protection (ACM3.2 differential current module required)	1	$I_d >>$	87G	< 40 ms (when the measured value increases from zero to two times the alarm set point)	<p>The RMS value of the fundamental frequency part of the sum/difference of the neutral side and consumer side currents, independent of the restraint current</p> <p>Operate value accuracy: Based on the largest secondary current</p> <ul style="list-style-type: none"> <li><math>I_{\text{secondary}} \leq 20 \text{ A}</math>: 1.5 % of <math>I_{\text{secondary}}</math> or <math>\pm 15 \text{ mA}</math></li> </ul>

Protection	Alarms	IEC symbol (IEC 60617)	ANSI (IEEE C37.2)	Operate time	Based on
					<ul style="list-style-type: none"> <li>20 A &lt; <math>I_{\text{secondary}} \leq 250</math> A: 2.5 % of <math>I_{\text{secondary}}</math></li> </ul>
Active synchroniser (including blackout close)	Not an alarm	-	25A	-	The frequency difference, the voltage difference, and the phase across the breaker

**NOTE** \* These operate times include the minimum user-defined delay of 100 ms.  
 \*\* The **BUS TIE breaker** controller has 4 directional-over current alarms.  
 \*\*\* This operate time includes the minimum user-defined delay of 20 ms.  
 \*\*\*\* Only for **HYBRID** controller.  
 \*\*\*\*\* The **BUS TIE breaker** controller has 3 power import alarms.

### AC protections for the B-side

Protection	Alarms	IEC symbol (IEC 60617)	ANSI (IEEE C37.2)	Operate time	Based on
Over-voltage	3	U>	59	< 50 ms	The highest phase-to-phase (or phase-to-neutral) voltage
Under-voltage	3	U<	27	< 50 ms	The lowest phase-to-phase (or phase-to-neutral) voltage
Voltage unbalance (voltage asymmetry)	1	UUB>	47	< 200 ms *	The highest difference between any of the 3 phase-to-phase (or phase-to-neutral) voltage true RMS values, and the average value
Positive sequence under-voltage	1	$U_1<$	27D	< 60 ms **	The estimated phase-to-neutral voltage phasors
Negative sequence voltage	1	$U_2>$	47	< 200 ms *	The estimated phase-to-neutral voltage phasors
Zero sequence voltage	1	$U_0$	59U <sub>0</sub>	< 200 ms *	The estimated phase-to-neutral voltage phasors
Over-frequency	2	f>	81O	< 50 ms	The lowest fundamental frequency of a phase voltage
Under-frequency	2	f<	81U	< 50 ms	The highest fundamental frequency of a phase voltage

**NOTE** \* This operate time includes the minimum user-defined delay of 100 ms.  
 \*\* This operate time includes the minimum user-defined delay of 20 ms.

### Other AC protections for the A-side

Protection	Alarms	IEC symbol (IEC 60617)	ANSI (IEEE C37.2)	Operate time	Based on
Earth inverse time over-current	1 *		51G	-	The current RMS value, measured by the 4th current measurement, filtered to attenuate the third harmonic (at least 18 dB).
Neutral inverse time over-current	1 *		51N	-	The current RMS value, measured by the 4th current measurement.

**NOTE** \* These protections each need the 4th current measurement. You can therefore only use one of these protections.

### Other features

Feature	IEC symbol (IEC 60617)	ANSI (IEEE C37.2)	Operate time	Based on
Lockout relay		86	-	Protected equipment. Alarms can be configured with a Latch, which remain active until the operator resets the latch.



We would love to hear from you.

Help us improve our documentation by giving us feedback.

[Click here](#)

# 1.4 Applications

## 1.4.1 Applications

With power management, the controller can handle simple or advanced applications for a variety of marine and offshore industry projects. Applications include synchronising generators, critical power, emergency standby, and power production.

The complete system is easily monitored and controlled from PICUS through a graphical supervision page. The values that are presented in the intuitive and easy-to-use user interface include the running status, hours in operation, breaker status, condition of shore and busbars, and fuel consumption.

### Example application with Load sharing

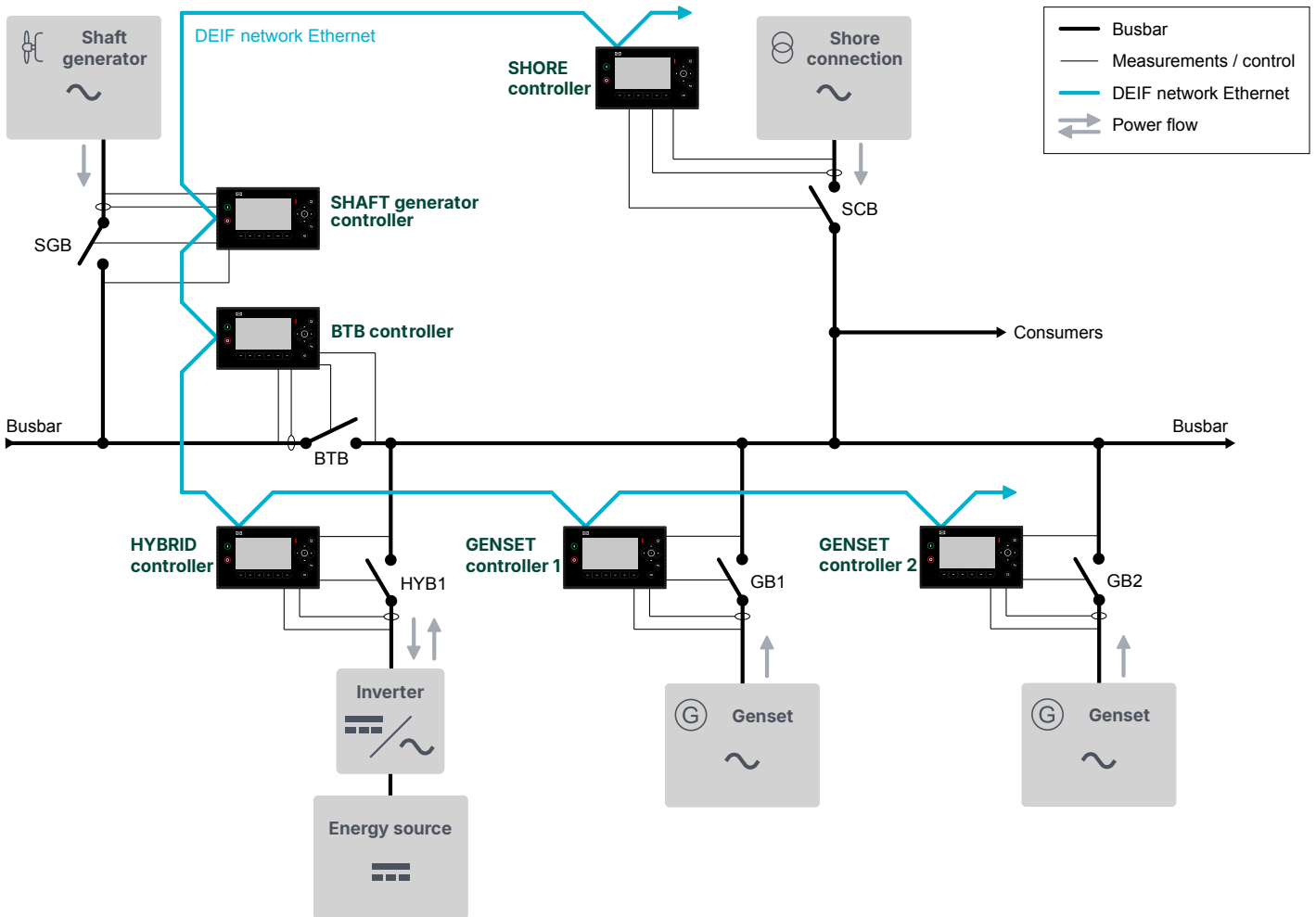

## Example application with Power management

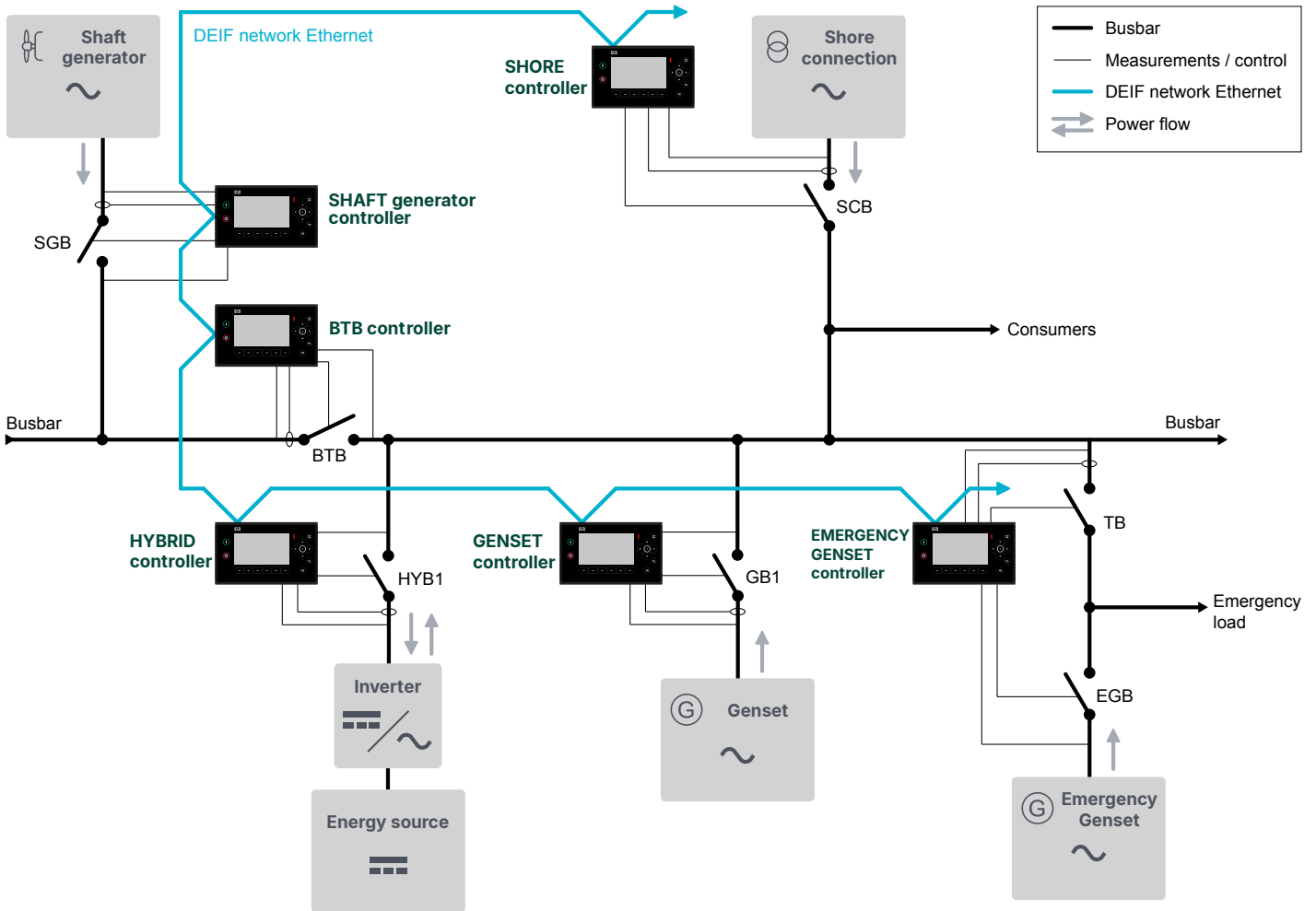

### 1.4.2 Extension rack functions

	Functions
<b>General</b>	<ul style="list-style-type: none"> <li>• Extends I/O interface <ul style="list-style-type: none"> <li>◦ 6 additional hardware modules in Rack7.1</li> <li>◦ 3 additional hardware modules in Rack4.1</li> </ul> </li> </ul>

## 1.5 Compatible products

### 1.5.1 DEIF digital voltage controllers (DVC)

**DVC 350** is a digital AVR designed for alternators with SHUNT, AREP or PMG excitation. The DVC 350 monitors and regulates the alternator output voltage. iE 350 can control the DVC 350 features and receive fault information directly with the CAN bus communication.



**More information**

See [www.deif.com/products/dvc-350](http://www.deif.com/products/dvc-350)

**DVC 550** is an advanced digital AVR designed for alternators with SHUNT, AREP or PMG excitation. The DVC 550 monitors and regulates the alternator output voltage. iE 350 can control all the DVC 550 features and receive fault information directly with the CAN bus communication.



**More information**

See [www.deif.com/products/dvc-550](http://www.deif.com/products/dvc-550)

## 1.5.2 Additional inputs and outputs

### Series 300 extension modules

You can use the Series 300 extensions racks and range of modules.



#### More information

See [www.deif.com/products/series-300-modules/](http://www.deif.com/products/series-300-modules/) for information about all the racks and modules.

### Extension racks

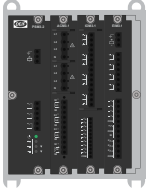

#### Extension rack R4.1

1 PSM3.2  
3 module selection

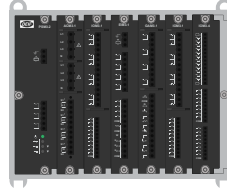

#### Extension rack R7.1

1 PSM3.2  
6 module selection

### Modules



#### IOM3.1 - Input/output module

4 changeover relay outputs  
10 digital inputs



#### IOM3.2 - Input/output module

4 relay outputs  
4 analogue multifunctional outputs (including 2 pulse width modulation PWM outputs)  
4 digital inputs  
4 analogue multifunctional inputs



#### IOM3.3 - Input/output module

10 analogue multifunctional inputs



#### IOM3.4 - Input/output module

12 digital outputs  
16 digital inputs

### iE 650 modules

You can use CODESYS to use modules from iE 650.



#### More information

See the **iE 650 PLC Data sheet** for details of these modules.

#### Rack6-4 (4 slots)

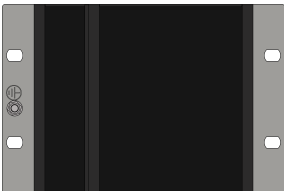

#### Rack6-14 (14 slots)

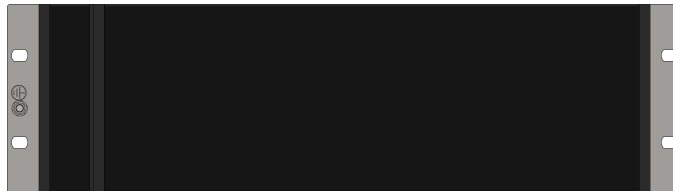

Racks with 6, 8, 10, and 12 slots are also available.

## Modules



### **DIO6-2 - Input/output module**

16 digital inputs  
16 digital outputs



### **DIM6-1 - Input module**

32 digital inputs



### **DOM6-1 - Output module**

32 digital outputs



### **AIO6-2 - Input/output module**

8 analogue outputs  
8 analogue inputs



### **AOM6-2 - Output module**

8 analogue inputs



### **AIM6-1 - Input module**

16 analogue outputs  
(Use AIM6-2 if only 8 analogue outputs are required)

## 1.5.3 Other equipment

DEIF has a wide variety of other equipment that is compatible. This includes synchroscopes, meters, transducers, current transformers, power supplies, and battery chargers.



### **More information**

See [www.deif.com](http://www.deif.com)

## 2. Technical specifications

### 2.1 Dimensions

#### 2.1.1 iE 7 display

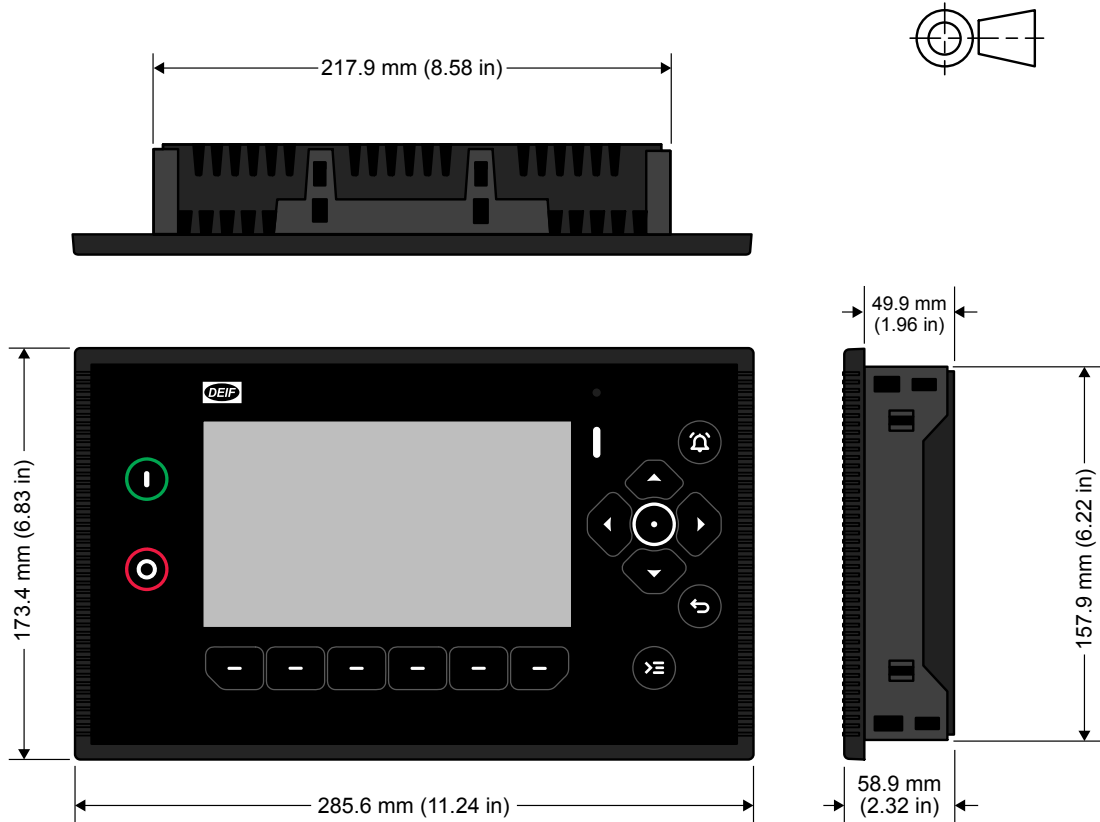

Category	Specifications
<b>Dimensions</b>	L×H×D: 285.6 × 173.4 × 58.9 mm (11.24 × 6.83 × 2.32 in) (outer frame)
<b>Panel cutout</b>	L×H: 220 × 160 mm (8.67 × 6.30 in)
<b>Weight</b>	840 g (1.9 lb)

Category	Specifications
<b>Display</b>	7", Projected Capacitive (PCAP), Touch
<b>Resolution</b>	1024x600 pixels (px)
<b>Brightness</b>	1200 Cd/m <sup>2</sup>
<b>Processor</b>	1.6 GHz quad-core industrial grade ARMv8 64 bit CPU with ECC protected cache

## 2.1.2 Rack R4.1

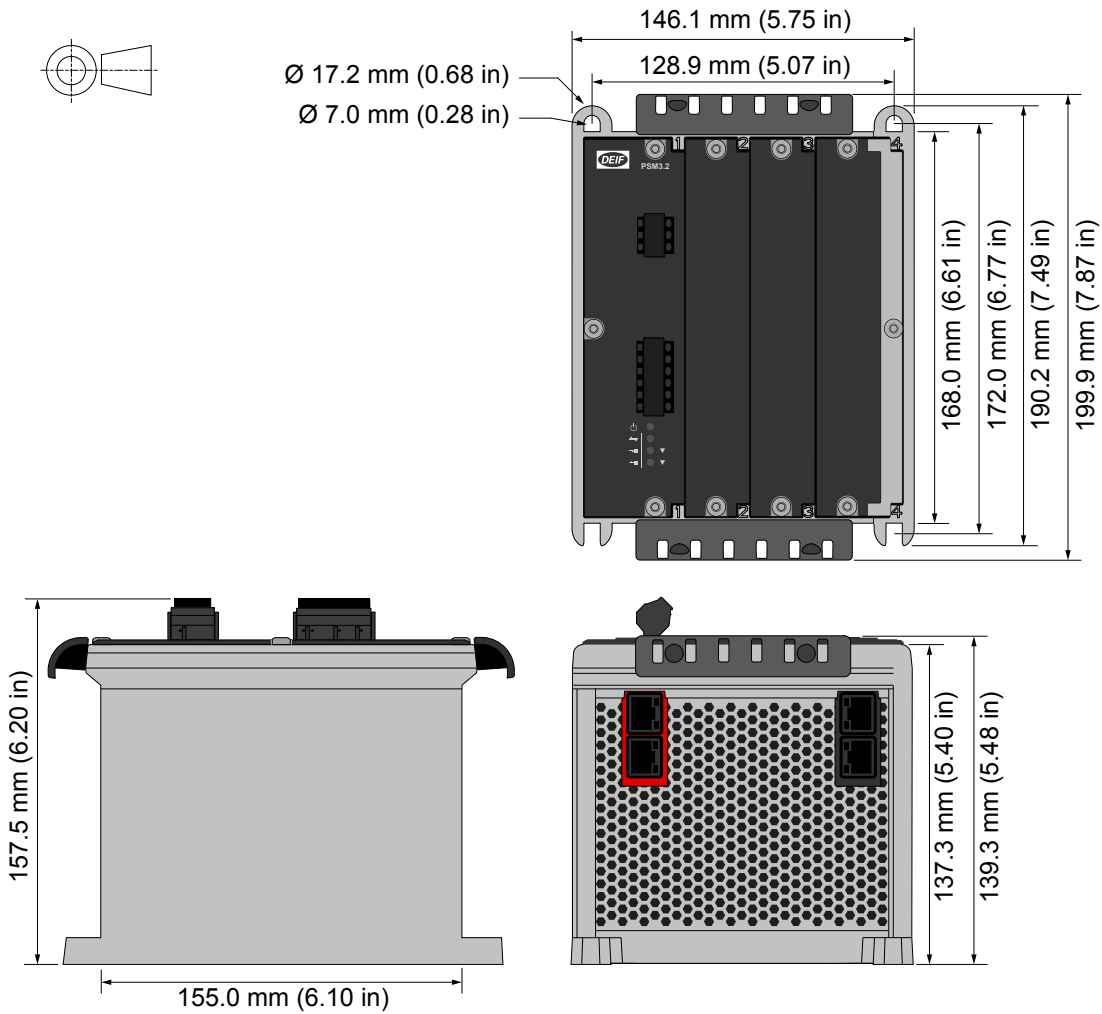

Category	Specification
<b>Dimensions</b>	L 146.1 mm x H 199.9 mm x D 157.5 mm (5.75 in x 7.87 in x 6.20 in) (outer frame, includes cable strain relief plates)
<b>Weight</b>	Without any hardware modules: 994 g (2.2 lb)

### 2.1.3 Rack R71

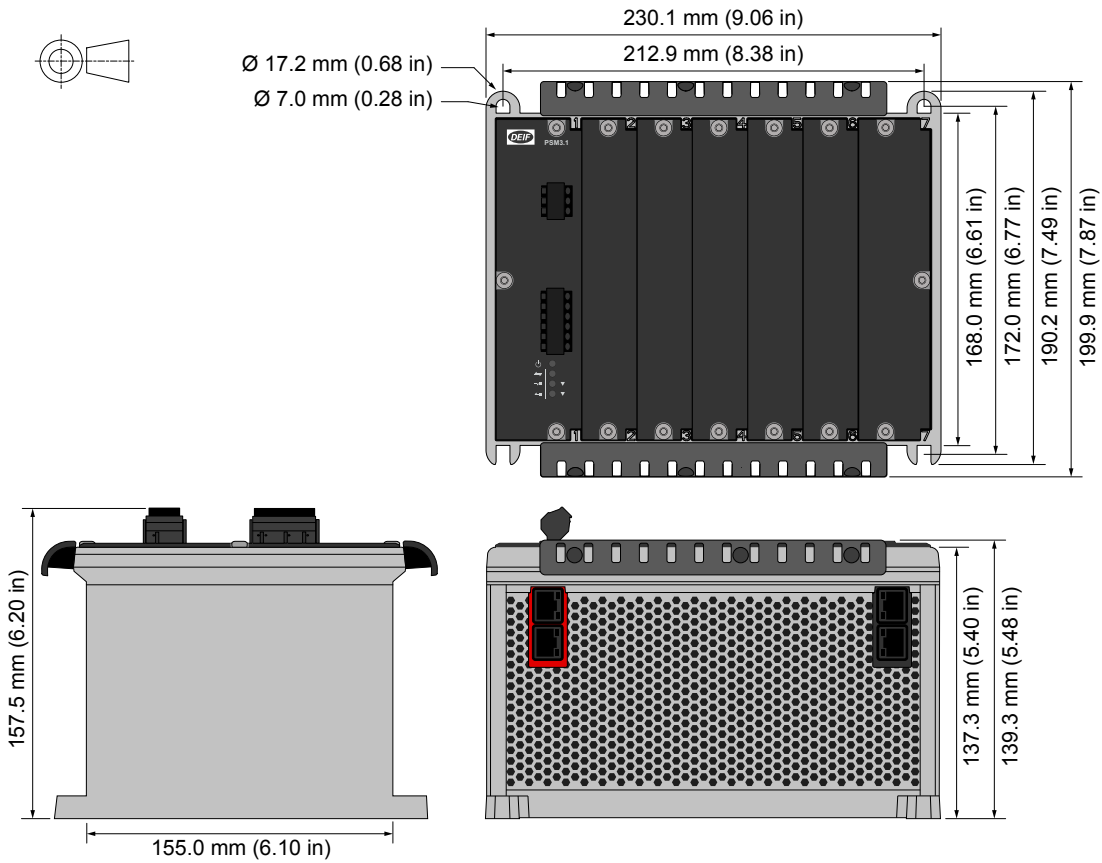

Category	Specification
<b>Dimensions</b>	L 230.1 mm x H 199.9 mm x D 157.5 mm (9.06 in x 7.87 in x 6.20 in) (outer frame, includes cable strain relief plates)
<b>Weight</b>	Without any hardware modules: 1330 g (2.9 lb)

## 2.2 Mechanical specifications

### 2.2.1 iE 7 display

Mechanical specifications	
<b>Vibration</b>	Response: <ul style="list-style-type: none"> <li>10 to 58.1 Hz, 0.15 mmpp</li> <li>58.1 to 150 Hz, 1 g. To IEC 60255-21-1 (Class 2)</li> </ul> Endurance: <ul style="list-style-type: none"> <li>10 to 150 Hz, 2 g. To IEC 60255-21-1 (Class 2)</li> </ul> Seismic vibration: <ul style="list-style-type: none"> <li>3 to 8.15 Hz, 15 mmpp</li> <li>8.15 to 35 Hz, 2 g. To IEC 60255-21-3 (Class 2)</li> </ul>
<b>Shock</b>	10 g, 11 ms, half sine. To IEC 60255-21-2 Response (Class 2) 30 g, 11 ms, half sine. To IEC 60255-21-2 Withstand (Class 2) 50 g, 11 ms, half sine. To IEC 60068-2-27, test Ea Tested with three impacts in each direction in three axes (total of 18 impacts per test)
<b>Bump</b>	20 g, 16 ms, half sine IEC 60255-21-2 (Class 2) Tested with 1000 impacts in each direction on three axes (total of 6000 impacts per test)
<b>Controller ports without galvanic separation</b>	DisplayPort, USB ports
<b>Safety</b>	Installation CAT. III 600 V Pollution degree 2 IEC 60255-27
<b>Flammability</b>	All plastic parts are self-extinguishing to UL94-V0
<b>EMC</b>	IEC 60255-26

**NOTE**  $g$  = gravitational force (g-force).

### 2.2.2 Rack R7.1 or R4.1

The general technical specifications apply to all hardware. Refer to the other sections for the specific technical specifications for specific hardware.

The specifications and approvals apply to the rack with all the hardware modules properly installed.

Mechanical specifications		
<b>Vibration</b>	Operation	3 to 8 Hz: 17 mm peak-to-peak 8 to 100 Hz: 4 g 100 to 500 Hz: 2 g
	Response	10 to 58.1 Hz: 0.15 mm peak-to-peak 58.1 to 150 Hz: 1 g
	Endurance	10 to 150 Hz: 2 g
	Seismic	3 to 8.15 Hz: 15 mm peak-to-peak 8.15 to 35 Hz: 2 g
	IEC 60068-2-6, IACS UR E10, IEC 60255-21-1 (class 2), IEC 60255-21-3 (class 2)	

## Mechanical specifications

<b>Shock (base-mounted)</b>	10 g, 11 ms, half sine IEC 60255-21-2 Response class 2 30 g, 11 ms, half sine IEC 60255-21-2 Endurance class 2 50 g, 11 ms, half sine IEC 60068-2-27
<b>Bump</b>	20 g, 16 ms, half sine IEC 60255-21-2 class 2
<b>Material</b>	All plastic materials are self-extinguishing according to UL94 (V0)

**NOTE**  $g$  = gravitational force (g-force).

## 2.3 Environmental specifications

### 2.3.1 iE 7 display

Environmental specifications	
Operating temperature	-30 to 70 °C (-22 to 158 °F)
Storage temperature	-30 to 80 °C (-22 to 176 °F)
Change of temperature	70 to -30 °C, 1 °C / minute, 5 cycles. To IEC 60255-1
Operating altitude	0 to 4000 m above sea level 2001 to 4000 m: Maximum 480 V AC
Operating humidity	Damp heat cyclic, 20/55 °C at 97 % relative humidity, 144 hours. To IEC 60255-1 Damp heat steady state, 40 °C at 93 % relative humidity, 240 hours. To IEC 60255-1
Protection degree	EN IEC 60529 <ul style="list-style-type: none"><li>• IP65 (front of module when installed into the control panel with the supplied sealing gasket)</li><li>• IP20 on terminal side</li></ul>

### 2.3.2 Rack R4.1 and R7.1

Environmental specifications	
Humidity	97 % relative humidity condensing, to IEC 60068-2-30
Operating temperature, rack and modules	-40 to 70 °C (-40 to 158 °F) UL/cUL Listed: maximum surrounding air temperature: 55 °C (131 °F)
Operating temperature, display unit	-20 to 70 °C (-4 to 158 °F) UL/cUL Listed: maximum surrounding air temperature: 55 °C (131 °F)
Storage temperature, rack and modules	-40 to 80 °C (-40 to 176 °F)
Storage temperature, display unit	-30 to 80 °C (-22 to 176 °F)
Operating altitude	Up to 4,000 m (13,123 ft) Refer to the module specifications for information on altitude derating over 2,000 m (6,562 ft)

## 2.4 Hardware modules











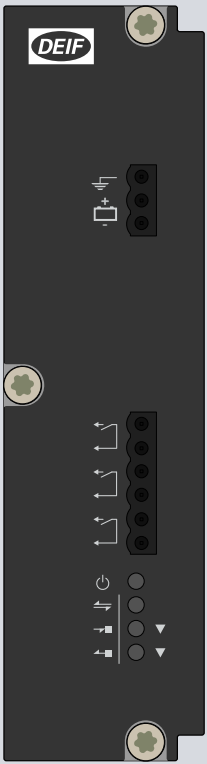

### 2.4.1 Power supply module PSM3.1 (Controller)

The power supply module provides power to all hardware modules in the rack. The rack status and alarms activate the three relay outputs. There are two ports for internal communication (EtherCAT) only with extension racks.



The PSM3.1 must to be powered by a power supply with Power Boost function.

The PSM3.1 manages the hardware module self-checks for the rack and includes a power LED. The power supply terminals include circuit protection against load dump transients and JEM177 surge transients (rugged design). These terminals also include battery voltage measurement.

#### PSM3.1 terminals

Module	Count	Symbol	Type/Info	Name
	1		Ground	Frame ground
	1		12 or 24 V	Power supply
	3		Relay output	1 × Status OK (fixed) 2 × configurable
	1		<ul style="list-style-type: none"> <li>● <b>Off</b> : No power supply</li> <li> <b>Red flash</b> : PSM is starting or module failure</li> <li>● <b>Green</b> : Power supply</li> <li> <b>Green flash</b> : Controller identification</li> </ul>	Power supply indication
	1		<ul style="list-style-type: none"> <li>● <b>Off</b> : No EtherCAT communication</li> <li>● <b>Green</b> : EtherCAT Communication</li> </ul>	EtherCAT communication connections (to connect to extension racks).
	1		EtherCAT communication (RJ45) input <ul style="list-style-type: none"> <li>● <b>Off</b> : No communication</li> <li>● <b>Green</b> : Communication connected</li> <li> <b>Green flash</b> : Active communication</li> </ul>	LEDs are on the module front, connections are at the module bottom.
	1		EtherCAT communication (RJ45) output <ul style="list-style-type: none"> <li>● <b>Off</b> : No communication</li> <li>● <b>Green</b> : Communication connected</li> <li> <b>Green flash</b> : Active communication</li> </ul>	

#### PSM3.1 technical specifications

Category	Specification
<b>Frame ground</b> 	Voltage withstand: ±36 V DC to the power supply positive (terminal 1) and negative (terminal 2)
<b>Controller power supply</b> 	Input voltage: 12 or 24 V DC nominal (8 to 36 V DC continuously) UL/cUL Listed: 10 to 32.5 V DC 0 V DC for 50 ms when coming from at least 8 V DC (cranking dropout) Consumption: Typical 20 W, maximum 35 W Voltage measurement accuracy: 0 to 30 V: ±1 V; 30 to 36 V: +1/-2 V Internal protection: 12 A fuse (not replaceable) (fuse size determined by load dump requirements) Voltage withstand: ±36 V DC Load dump protected by TVS diodes  <b>Start current</b>

Category	Specification
	<ul style="list-style-type: none"> <li>Power supply current limiter <ul style="list-style-type: none"> <li>24 V: 4 A minimum</li> <li>12 V: 8 A minimum</li> </ul> </li> <li>Battery: No limit</li> </ul>
<b>Relay outputs</b> 	Relay type: Solid state Electrical rating and UL/cUL Listed: 30 V DC and 1 A, resistive Voltage withstand: ±36 V DC
<b>Terminal connections</b>	<b>Frame ground and power supply:</b> <ul style="list-style-type: none"> <li>Terminals: Standard 45° plug, 2.5 mm<sup>2</sup></li> <li>Wiring: 1.5 to 2.5 mm<sup>2</sup> (16 to 12 AWG), multi-stranded</li> </ul> <b>Other connections:</b> <ul style="list-style-type: none"> <li>Terminals: Standard 45° plug, 2.5 mm<sup>2</sup></li> <li>Wiring: 0.5 to 2.5 mm<sup>2</sup> (22 to 12 AWG), multi-stranded</li> </ul>
<b>Communication connections</b>	EtherCAT communication: RJ45. Use an Ethernet cable that meets or exceeds the SF/UTP CAT5e specifications
<b>Torques and terminals</b>	Module faceplate screws: 0.5 N·m (4.4 lb-in) Connection of wiring to terminals: 0.5 N·m (4.4 lb-in) UL/cUL Listed: Wiring must be minimum 90 °C (194 °F) copper conductors only
<b>Galvanic isolation</b>	Between power supply and other I/Os: 600 V, 50 Hz for 60 s Between relay groups and other I/Os: 600 V, 50 Hz for 60 s Between internal communication ports and other I/Os: 600 V, 50 Hz for 60 s
<b>Ingress protection</b>	Unmounted: No protection rating Mounted in rack: IP20 according to IEC/EN 60529
<b>Dimensions</b>	L×H×D: 43.3 × 162 × 150 mm (1.5 × 6.4 × 5.9 in)
<b>Weight</b>	331 g (0.7 lb)

## 2.4.2 Power supply module PSM3.2 (Extension)

The power supply module provides power to all hardware modules in the extension rack. There are two ports for internal communication with the main controller. The internal communication (EtherCAT) connections are only used to communicate with the main controller. The rack status and alarms activate the three relay outputs.

The PSM3.2 must to be powered by a power supply with Power Boost function.

The PSM3.2 manages the hardware module self-checks for the rack and includes a power LED. The power supply terminals include circuit protection against load dump transients and JEM177 surge transients (rugged design). These terminals also include battery voltage measurement.

## PSM3.2 terminals

Module	Count	Symbol	Type/Info	Name
	1		Ground	Frame ground
	1		12 or 24 V	Power supply
	3		Relay output	1 × Status OK (fixed) 2 × configurable
	1		<ul style="list-style-type: none"> <li>● <b>Off</b> : No power supply</li> <li>🔴 <b>Red flash</b> : PSM is starting or module failure</li> <li>● <b>Green</b> : Power supply</li> <li>🟢 <b>Green flash</b> : Rack identification</li> </ul>	Power supply indication
	1		<ul style="list-style-type: none"> <li>● <b>Off</b> : No EtherCAT communication</li> <li>● <b>Green</b> : EtherCAT Communication</li> </ul>	EtherCAT communication connections (to connect to the racks).
	1		EtherCAT communication (RJ45) input <ul style="list-style-type: none"> <li>● <b>Off</b> : No communication</li> <li>● <b>Green</b> : Communication connected</li> <li>🟢 <b>Green flash</b> : Active communication</li> </ul>	LEDs are on the module front, connections are at the module bottom.
	1		EtherCAT communication (RJ45) output <ul style="list-style-type: none"> <li>● <b>Off</b> : No communication</li> <li>● <b>Green</b> : Communication connected</li> <li>🟢 <b>Green flash</b> : Active communication</li> </ul>	

## PSM3.2 technical specifications

Category	Specification
<b>Frame ground</b>	Voltage withstand: ±36 V DC to the power supply positive (terminal 1) and negative (terminal 2)
<b>Controller power supply</b> 	Input voltage: 12 or 24 V DC nominal (8 to 36 V DC continuously) UL/cUL Listed: 10 to 32.5 V DC 0 V DC for 50 ms when coming from at least 8 V DC (cranking dropout) Consumption: Typical 20 W, maximum 35 W Voltage measurement accuracy: 0 to 30 V: ±1 V; 30 to 36 V: +1/-2 V Internal protection: 12 A fuse (not replaceable) (fuse size determined by load dump requirements) Voltage withstand: ±36 V DC Load dump protected by TVS diodes  <b>Start current</b> <ul style="list-style-type: none"> <li>• Power supply current limiter               <ul style="list-style-type: none"> <li>◦ 24 V: 4 A minimum</li> <li>◦ 12 V: 8 A minimum</li> </ul> </li> <li>• Battery: No limit</li> </ul>
<b>Relay outputs</b> 	Relay type: Solid state Electrical rating and UL/cUL Listed: 30 V DC and 1 A, resistive Voltage withstand: ±36 V DC
<b>Terminal connections</b>	<b>Frame ground and power supply:</b> <ul style="list-style-type: none"> <li>• Terminals: Standard 45° plug, 2.5 mm<sup>2</sup></li> <li>• Wiring: 1.5 to 2.5 mm<sup>2</sup> (16 to 12 AWG), multi-stranded</li> </ul> <b>Other connections:</b>



Category	Specification
	<ul style="list-style-type: none"> <li>Terminals: Standard 45° plug, 2.5 mm<sup>2</sup></li> <li>Wiring: 0.5 to 2.5 mm<sup>2</sup> (22 to 12 AWG), multi-stranded</li> </ul>
<b>Communication connections</b>	EtherCAT communication: RJ45. Use an Ethernet cable that meets or exceeds the SF/UTP CAT5e specifications
<b>Torques and terminals</b>	Module faceplate screws: 0.5 N·m (4.4 lb-in) Connection of wiring to terminals: 0.5 N·m (4.4 lb-in) UL/cUL Listed: Wiring must be minimum 90 °C (194 °F) copper conductors only
<b>Galvanic isolation</b>	Between power supply and other I/Os: 600 V, 50 Hz for 60 s Between relay groups and other I/Os: 600 V, 50 Hz for 60 s Between internal communication ports and other I/Os: 600 V, 50 Hz for 60 s
<b>Ingress protection</b>	Unmounted: No protection rating Mounted in rack: IP20 according to IEC/EN 60529
<b>Dimensions</b>	L×H×D: 43.3 × 162 × 150 mm (1.5 × 6.4 × 5.9 in)
<b>Weight</b>	331 g (0.7 lb)

### 2.4.3 Alternating current module ACM3.1

The alternating current module ACM3.1 measures the voltage and current on one side of a breaker, and the voltage on the other side. The hardware module responds when the measurements exceed the AC alarm parameters.

ACM3.1 provides robust frequency detection in environments with electrical noise. ACM3.1 allows extended measurement bandwidth up to 40 times the nominal frequency. ACM3.1 includes a configurable 4th current measurement.

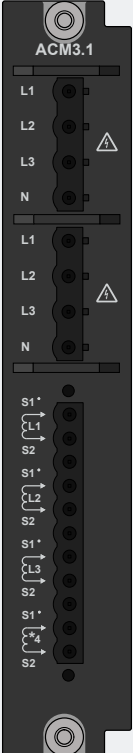
#### ACM3.1 terminals

Module	Count	Symbol	Type	Name
	2 × (L1, L2, L3 and N)	L1/L2/L3/N	Voltage	3-phase voltage measurements
	1 × (L1, L2, L3 and 4th)		Current	3-phase current measurement  4th current measurement

## ACM3.1 technical specifications

Category	Specification
<b>Voltage measurements</b>	Nominal value: 100 to 690 V AC phase-to-phase Measurement range: 2 to 897 V AC phase-to-phase Accuracy: Class 0.2 Phase angle accuracy: 0.1° (within nominal voltage range and nominal frequency range) Altitude derating from 2,000 to 4,000 m (6,562 to 13,123 ft): 100 to 480 V AC phase-to-phase UL/cUL Listed: 100 to 600 V AC phase-to-phase Load on external voltage transformer: Maximum 0.2 VA/phase Voltage withstand: 1.2 × Nominal voltage continuously; 1.3 × Nominal voltage for 10 s
<b>Current measurements</b>	Nominal value: 1 or 5 A AC from current transformer Measurement range: 0.02 to 17.5 A AC from current transformer; Truncation level: 11 mA Accuracy: Class 0.2 Earth current: 18 dB attenuation of third harmonic of the nominal frequency UL/cUL Listed: From listed or R/C (XODW2.8) current transformers 1 or 5 A Load on external current transformer: Maximum 0.3 VA/phase Current withstand: 10 A continuously; 17.5 A for 60 s; 100 A for 10 s; 250 A for 1 s
<b>Frequency measurements</b>	Nominal value: 50 Hz or 60 Hz Measurement range: 35 to 78 Hz Accuracy: Class 0.1 of nominal value (35 to 78 Hz) (-40 to 70 °C) (-40 to 158 °F) Class 0.02 of nominal value (40 to 70 Hz) (15 to 30 °C) (59 to 86 °F)
<b>Power measurements</b>	Accuracy: Class 0.5
<b>Accuracy and temperature</b>	Unless otherwise specified for the above measurements: Nominal range: -40 to 70 °C (-40 to 158 °F) Reference range: 15 to 30 °C (59 to 86 °F) Accuracy: Measurement type specific within reference range Additional 0.2 % error of full scale per 10 °C (18 °F) outside reference range
<b>Torques and terminals</b>	Module faceplate screws: 0.5 N·m (4.4 lb-in) Secure the current measurement terminal block to the module faceplate: 0.25 N·m (2.2 lb-in) Connection of wiring to terminals: 0.5 N·m (4.4 lb-in) UL/cUL Listed: Wiring must be minimum 90 °C (194 °F) copper conductors only
<b>Terminal connections</b>	AC voltage and current terminals: Standard 45° plugs, 2.5 mm <sup>2</sup> Wiring: 2.5 mm <sup>2</sup> (13 AWG), multi-stranded
<b>Galvanic isolation</b>	Between AC voltage and other I/Os: 3310 V, 50 Hz for 60 s Between AC current and other I/Os: 2210 V, 50 Hz for 60 s
<b>Ingress protection</b>	Unmounted: No protection rating Mounted in rack: IP20 according to IEC/EN 60529
<b>Dimensions</b>	L×H×D: 28 × 162 × 150 mm (1.1 × 6.4 × 5.9 in)
<b>Accessories (included)</b>	<ul style="list-style-type: none"> <li>• One roundel with 6 J-shaped voltage encoding pins (for the hardware module)</li> <li>• One roundel with 6 flat voltage encoding pins (for the voltage terminal blocks)</li> </ul>
<b>Weight</b>	232 g (0.5 lb)

### 2.4.4 Differential current module ACM3.2

The differential current module ACM3.2 measures the generator outgoing 3-phase currents (consumer side) and star point 3-phase currents. The ACM3.2 uses the measurements to detect phase-to-phase faults or phase-to-earth faults (star point earthed generator stator only) in the generator stator, and dependent on the mounting of the CT's on the outgoing side, possibly also the cable between the generator and the main switchboard.

The protection consists of:

- A stabilised stage that uses an operating characteristic formed by a fixed and two sloped regions. This current restraint approach is also known as biased differential protection.
- A high set fixed differential stage (non-stabilised).

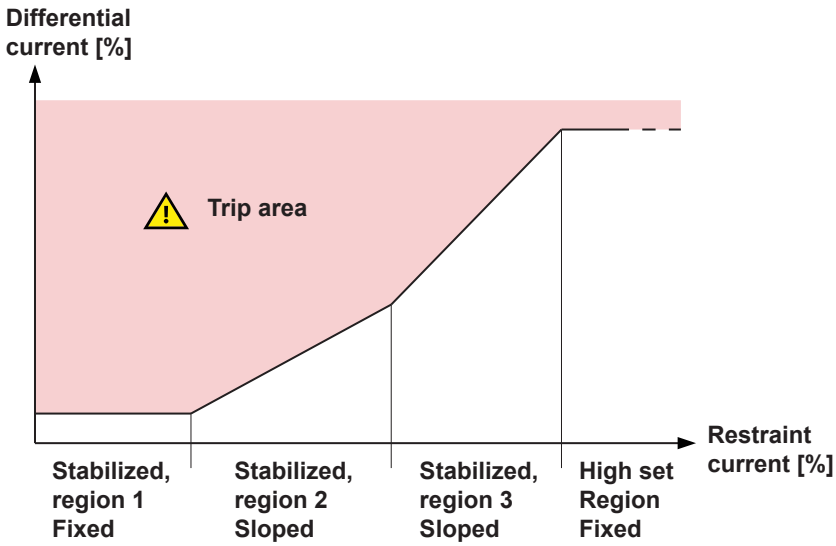

### ACM3.2 terminals

Module	Count	Symbol	Type	Name
	1 × (L1, L2 and L3)		Current	3-phase current measurement - Consumer side
	1 × (L1, L2 and L3)		Current	3-phase current measurement - Neutral side

### ACM3.2 technical specifications

Category	Specification
<b>Nominal, reference and operating values</b>	Current: Nominal value: 1 or 5 A AC from current transformer Frequency: <ul style="list-style-type: none"> <li>Nominal value: 50 or 60 Hz</li> <li>Reference range: 40 to 70 Hz</li> <li>Operating range: 20 to 78 Hz</li> </ul> Temperature: <ul style="list-style-type: none"> <li>Reference range: 15 to 30 °C (59 to 86 °F)</li> <li>Operating range: -40 to 70 °C (-40 to 158 °F)</li> </ul>
<b>Current measurements</b>	Measurement range: 0.025 to 250 A AC. Truncation level: 20 mA

Category	Specification
	Accuracy: <ul style="list-style-type: none"> <li>• 0.025 to 20 A: <math>\pm 1\%</math> or <math>\pm 10</math> mA of measured current (whichever is greater)</li> <li>• 20 to 250 A: <math>\pm 1.5\%</math> of measured current</li> </ul> UL/cUL Listed: From listed or R/C (XODW2.8) current transformers 1 or 5 A Load on external current transformer: $< 4$ m $\Omega$ , including the terminal block Current withstand: <ul style="list-style-type: none"> <li>• 20 A continuously</li> <li>• 100 A for 10 s</li> <li>• 400 A for 1 s</li> <li>• 1250 A for 10 ms (half wave)</li> </ul>
<b>Frequency measurement</b>	Accuracy (within operating range): $> 0.1$ A: $\pm 0.1\%$ of actual frequency
<b>Temperature</b>	Current measurement accuracy temperature coefficient: $\pm 0.25\%$ , or $\pm 2.5$ mA per 10 °C (18 °F) outside reference range (whichever is greater)
<b>Torques and terminals</b>	Module faceplate screws: 0.5 N·m (4.4 lb-in) Secure the current measurement terminal block to the module faceplate: 0.25 N·m (2.2 lb-in) Connection of wiring to terminals: <ul style="list-style-type: none"> <li>• <math>\leq 4</math> mm<sup>2</sup>: 0.5 N·m (4.4 lb-in) to 0.6 N·m (5.3 lb-in)</li> <li>• <math>&gt; 4</math> mm<sup>2</sup>: 0.7 N·m (6.2 lb-in) to 0.8 N·m (7.1 lb-in)</li> </ul> UL/cUL Listed: Wiring must be minimum 90 °C (194 °F) copper conductors only
<b>Terminal connections</b>	AC current terminals: Standard 0° plugs, 6 mm <sup>2</sup> with securing screws Wiring: 2.5 to 6 mm <sup>2</sup> (13 to 10 AWG), multi-stranded
<b>Galvanic isolation</b>	Between AC current and other I/Os: 2210 V, 50 Hz for 60 s
<b>Ingress protection</b>	Unmounted: No protection rating Mounted in rack: IP20 according to IEC/EN 60529
<b>Dimensions</b>	L×H×D: 28 × 162 mm × 152 mm (1.1 × 6.4 × 5.9 in)
<b>Weight</b>	230 g (0.5 lb) (including terminal blocks)
<b>Accessories (included)</b>	One roundel with 6 encoding pins (for the hardware module and terminal block)







### 2.4.5 Engine interface module EIM3.1

The engine interface module has its own power supply and a tacho input to measure speed. It also has four relay outputs, four digital inputs, and three analogue inputs. These I/Os are configurable.

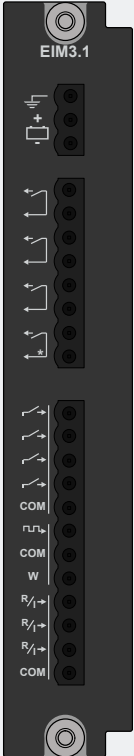
The power supply terminals include circuit protection against load dump transients and JEM177 surge transients (rugged design). These terminals also include battery voltage measurement.





EIM3.1 has its own microprocessor. If the rack power supply fails, or connection to the application is lost, the EIM3.1 can continue to operate independent of the application.



## EIM3.1 terminals

Module	Count	Symbol	Type	Name
	1		Ground	Frame ground
	1		12 or 24 V DC	Power supply
	3		Relay output	Configurable
	1		Relay output (with wire break detection)	Configurable
	4		Digital input	Configurable
	1		MPU input (with wire break detection)*	Magnetic pickup
	1	W	W input (no wire break detection)*	Generator tacho output or NPN/PNP sensor
	3	$R/I \rightarrow$	Analogue current or resistance measurement input (RMI)	Configurable

**NOTE** \* These inputs cannot both be used at the same time.

## EIM3.1 technical specifications

Category	Specification
<b>Frame ground</b> 	Voltage withstand: $\pm 36$ V DC to the power supply positive (terminal 1) and negative (terminal 2)
<b>Auxiliary power supply</b> 	Input voltage: 12 or 24 V DC nominal (8 to 36 V DC continuously) UL/cUL Listed: 10 to 32.5 V DC 0 V DC for 50 ms when coming from at least 8 V DC (cranking dropout) Consumption: Typical 3 W, maximum 5 W Internal protection: by 12 A fuse (not replaceable) (fuse size determined by load dump requirements) Voltage withstand: $\pm 36$ V DC Load dump protected by TVS diodes  <b>Start current</b> <ul style="list-style-type: none"> <li>• Power supply current limiter               <ul style="list-style-type: none"> <li>◦ 24 V: 0.6 A minimum</li> <li>◦ 12 V: 1.2 A minimum</li> </ul> </li> <li>• Battery: No limit</li> </ul>
<b>Relay outputs</b> 	Relay type: Electromechanical Electrical rating and UL/cUL Listed: 30 V DC and 6 A, resistive Voltage withstand: $\pm 36$ V DC
<b>Relay output with wire break detection</b> 	Relay type: Electromechanical Electrical rating and UL/cUL Listed: 30 V DC and 6 A, resistive Includes wire break detection Voltage withstand: $\pm 36$ V DC
<b>Magnetic pickup</b> 	Voltage: 3 to 70 V AC peak Frequency: 2 to 20,000 Hz

Category	Specification
	Accuracy: 2 to 99 Hz: 0.5 Hz; 100 to 20,000 Hz: $\pm 0.5$ % of measurement Cable supervision: Resistance maximum 100 k $\Omega$ Includes wire break detection Voltage withstand: 70 V AC
<b>Generator tachometer (W)</b>	Voltage: 8 to 36 V DC Frequency: 2 to 20,000 Hz Accuracy: 2 to 99 Hz: 0.5 Hz; 100 to 20,000 Hz: $\pm 0.5$ % of measurement No wire break detection Voltage withstand: $\pm 36$ V DC
<b>NPN/PNP</b>	Voltage: 8 to 36 V DC Frequency: 2 to 20,000 Hz Accuracy: 2 to 99 Hz: 0.5 Hz; 100 to 20,000 Hz: $\pm 0.5$ % of measurement No wire break detection Voltage withstand: $\pm 36$ V DC
<b>Digital inputs</b> 	Bipolar inputs <ul style="list-style-type: none"> <li>ON: -36 to -8 V DC, and 8 to 36 V DC</li> <li>OFF: -2 to 2 V DC</li> </ul> Minimum pulse length: 50 ms Impedance: 4.7 k $\Omega$ Voltage withstand: $\pm 36$ V DC
<b>Analogue multi-functional inputs</b> 	<b>Current input</b> <ul style="list-style-type: none"> <li>From active transmitter: 0 to 20 mA, 4 to 20 mA, or any custom range between 0 and 25 mA</li> <li>Accuracy: 1 % of selected range</li> </ul> <b>Pt100/1000</b> <ul style="list-style-type: none"> <li>-40 to 250 °C (-40 to 482 °F)</li> <li>Accuracy: 1 % of full scale (to IEC/EN60751)</li> <li>Maximum sensor self-heating: 0.5 °C/mW (1 °F/mW)</li> </ul> <b>Resistance measurement</b> <ul style="list-style-type: none"> <li>Any custom range between 0 and 2.5 k<math>\Omega</math></li> <li>Accuracy: 1 % over ranges: 0 to 200 <math>\Omega</math>, 0 to 300 <math>\Omega</math>, 0 to 500 <math>\Omega</math>, 0 to 1000 <math>\Omega</math>, and 0 to 2500 <math>\Omega</math></li> </ul> <b>Digital input</b> <ul style="list-style-type: none"> <li>Dry contact with cable supervision</li> <li>Maximum circuit resistance: 330 <math>\Omega</math></li> <li>Minimum current rating for the connected relay: 2.5 mA</li> </ul> Voltage withstand: $\pm 36$ V DC All analogue multi-functional inputs for EIM3.1 have a common ground
<b>Terminal connections</b>	<b>Frame ground and power supply</b> <ul style="list-style-type: none"> <li>Terminals: Standard 45° plug, 2.5 mm<sup>2</sup></li> <li>Wiring: 1.5 to 2.5 mm<sup>2</sup> (16 to 12 AWG), multi-stranded</li> </ul> <b>Other connections</b> <ul style="list-style-type: none"> <li>Terminals: Standard 45° plug, 2.5 mm<sup>2</sup></li> <li>Wiring: 0.5 to 2.5 mm<sup>2</sup> (22 to 12 AWG), multi-stranded</li> </ul>
<b>Torques and terminals</b>	Module faceplate screws: 0.5 N·m (4.4 lb-in) Connection of wiring to terminals: 0.5 N·m (4.4 lb-in) UL/cUL Listed: Wiring must be minimum 90 °C (194 °F) copper conductors only
<b>Galvanic isolation</b>	Between relay groups and other I/Os: 600 V, 50 Hz for 60 s Between digital input groups and other I/Os: 600 V, 50 Hz for 60 s Between MPU and W inputs and other I/Os: 600 V, 50 Hz for 60 s Between analogue inputs and other I/Os: 600 V, 50 Hz for 60 s







Category	Specification
Ingress protection	Unmounted: No protection rating Mounted in rack: IP20 according to IEC/EN 60529
Dimensions	L×H×D: 28 × 162 × 150 mm (1.1 × 6.4 × 5.9 in)
Weight	250 g (0.5 lb)

## 2.4.6 Governor and AVR module GAM3.1

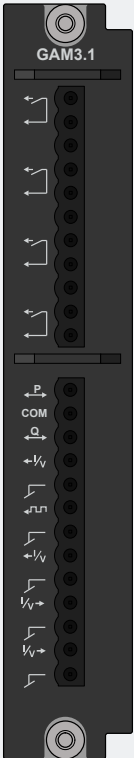



This governor and AVR module has four relay outputs, two analogue outputs and a pulse width modulation output, and two analogue inputs. These I/Os are configurable.

GAM3.1 also has terminals for analogue load sharing (future use).

### GAM3.1 terminals

Module	Count	Symbol	Type	Name
	4		Relay output	Configurable
	1		Load sharing	Active power (P) (kW) load sharing (future use)
	1		Load sharing	Reactive power (Q) (kvar) sharing (future use)
	2		Analogue current or voltage output	GOV/AVR/configurable
	1		Pulse width modulation (PWM) output	PWM output (with PWM ground)
	2		Analogue current or voltage input	Configurable

### GAM3.1 technical specifications

Category	Specification
<b>Relay outputs</b> 	Relay type: Electromechanical Electrical rating and UL/cUL Listed: 250 V AC or 30 V DC, and 6 A, resistive; B300, pilot duty (B300 is a power limit specification for inductive loads) Altitude derating from 2,000 to 4,000 m (6,562 to 13,123 ft): Maximum 150 V AC phase-to-phase Voltage withstand: 250 V AC
<b>Load sharing (future use)</b>  	Voltage input/output: -5 to 5 V DC Impedance: 23.5 kΩ Accuracy: 1 % of full scale, for both inputs and outputs Voltage withstand: ±36 V DC
<b>Analogue multi-functional outputs</b> 	<b>Current output</b> <ul style="list-style-type: none"> <li>-20 to 20 mA, or 0 to 20 mA, or 4 to 20 mA, or any custom range between -25 and 25 mA</li> <li>Accuracy: 1 % of the selected range (minimum range: 5 mA)</li> </ul>







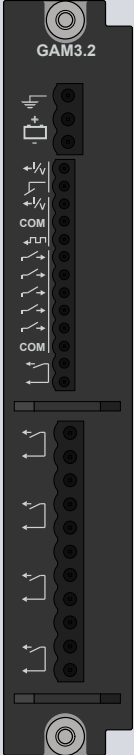

Category	Specification
	<ul style="list-style-type: none"> <li>16-bit resolution over the range -25 to 25 mA</li> <li>Active output (internal supply)</li> <li>Maximum load: 400 Ω</li> </ul> <b>Voltage output (DC)</b> <ul style="list-style-type: none"> <li>-10 to 10 V, 0 to 10 V, 0 to 5 V, -5 to 5 V, 0 to 3 V, -3 to 3 V, or 0 to 1 V, or any custom range between -10 and 10 V</li> <li>Accuracy: 1 % of the selected range (minimum range: 1 V)</li> <li>16-bit resolution over the range -10 to 10 V</li> <li>Minimum load: 600 Ω. Voltage output internal resistance: &lt; 1 Ω</li> </ul> Voltage withstand: ±36 V DC Controller power off: Internal resistance > 10 MΩ
<b>Pulse width modulation (PWM) output</b> ↔	Frequency: 500 Hz ±50 Hz Resolution: 43,200 levels Voltage: <ul style="list-style-type: none"> <li>Low level: &lt; 0.5 V</li> <li>High level: &gt; 5.5 V</li> <li>Maximum: 6.85 V</li> </ul> Output impedance: 100 Ω Nominal temperature range: -40 to 70 °C (-40 to 158 °F) Reference temperature range: 15 to 30 °C (59 to 86 °F) Duty cycle accuracy (5 to 95 %): 0.25 % within reference temperature range 0.2 % of full scale additional error per 10 °C (18 °F) outside the reference range Example: At 70 °C (158 °F) the accuracy of the PWM output is 0.25 % + 4 × 0.2 % = 1.05 % Voltage withstand: ±30 V DC
<b>Analogue multi-functional inputs</b> ↕	<b>Current inputs</b> <ul style="list-style-type: none"> <li>From active transmitter: 0 to 20 mA, 4 to 20 mA, or any custom range between 0 and 24 mA</li> <li>Accuracy: 1 % of selected range</li> </ul> <b>Voltage inputs (DC)</b> <ul style="list-style-type: none"> <li>-10 to 10 V, 0 to 10 V, or any custom range between -10 and 10 V</li> <li>Accuracy: 1 % of selected range</li> </ul> Voltage withstand: ±36 V DC
<b>Terminal connections</b>	Terminals: Standard 45° plug, 2.5 mm <sup>2</sup> Wiring: 0.5 to 2.5 mm <sup>2</sup> (22 to 12 AWG), multi-stranded
<b>Torques and terminals</b>	Module faceplate screws: 0.5 N·m (4.4 lb-in) Connection of wiring to terminals: 0.5 N·m (4.4 lb-in) UL/cUL Listed: Wiring must be minimum 90 °C (194 °F) copper conductors only
<b>Galvanic isolation</b>	Between individual relays and other I/Os: 2210 V, 50 Hz for 60 s Between load sharing and other I/Os: 600 V, 50 Hz for 60 s Between terminals 12 to 15 (analogue output 1, PWM output), and other I/Os: 600 V, 50 Hz for 60 s <ul style="list-style-type: none"> <li>Analogue output 1 and the PWM output are galvanically connected</li> </ul> Between terminals 16, 17 (analogue output 2) and other I/Os: 600 V, 50 Hz for 60 s Between terminals 18 to 21 (analogue inputs) and other I/Os: 600 V, 50 Hz for 60 s <ul style="list-style-type: none"> <li>Analogue inputs 1 and 2 are galvanically connected</li> </ul>
<b>Ingress protection</b>	Unmounted: No protection rating Mounted in rack: IP20 according to IEC/EN 60529
<b>Dimensions</b>	L×H×D: 28 × 162 × 150 mm (1.1 × 6.4 × 5.9 in)
<b>Weight</b>	224 g (0.5 lb)

## 2.4.7 Governor and AVR module GAM3.2



This governor and AVR module has its own power supply, two analogue outputs and a pulse width modulation output, five digital inputs, a status relay output, and four relay outputs. Apart from the status relay, all these I/Os are configurable.

GAM3.2 has its own microprocessor. If the rack power supply fails, GAM3.2 can continue to be used for manual operation if it has its own, independent power supply. The power supply terminals include circuit protection against load dump transients and JEM177 surge transients (rugged design). These terminals also include battery voltage measurement.

### GAM3.2 terminals

Module	Count	Symbol	Type	Name
	1		Ground	Frame ground
	1		12 or 24 V	Power supply
	2		Analogue current or voltage output	GOV/AVR/configurable
	1		Pulse width modulation (PWM) output	PWM output
	5		Digital input	Configurable
	1		Relay output	GAM3.2 status
	4		Relay output	Configurable

### GAM3.2 technical specifications

Category	Specification
<b>Auxiliary power supply</b> 	Input voltage: 12 or 24 V DC nominal (8 to 36 V DC continuously) UL/cUL Listed: 10 to 32.5 V DC 0 V DC for 50 ms when coming from at least 8 V DC (cranking dropout) Consumption: Typical 3 W, maximum 5 W Voltage measurement accuracy: $\pm 0.1$ V (measurement range 8 to 36 V DC) Internally protection: 12 A fuse (not replaceable) (fuse size determined by load dump requirements) Voltage withstand: $\pm 36$ V DC Load dump protected by TVS diodes  <b>Start current</b> <ul style="list-style-type: none"> <li>• Power supply current limiter               <ul style="list-style-type: none"> <li>◦ 24 V: 0.6 A minimum</li> <li>◦ 12 V: 1.2 A minimum</li> </ul> </li> <li>• Battery: No limit</li> </ul>
<b>Analogue multi-functional outputs</b> 	<b>Current output</b> <ul style="list-style-type: none"> <li>• Any custom range between -25 and 25 mA</li> <li>• Accuracy: 1 % of the selected range (minimum range: 5 mA)</li> </ul>



Category	Specification
	<ul style="list-style-type: none"> <li>16-bit resolution</li> <li>Active output (internal supply)</li> <li>Maximum load: 400 Ω</li> </ul> <b>Voltage output (DC)</b> <ul style="list-style-type: none"> <li>Any custom range between -10 and 10 V</li> <li>Accuracy: 1 % of the selected range (minimum range: 1 V)</li> <li>16-bit resolution</li> <li>Minimum load: 600 Ω. Voltage output internal resistance: &lt; 1 Ω.</li> </ul> Voltage withstand: ±36 V DC Controller power off: Internal resistance > 10 MΩ
<b>Pulse width modulation (PWM) output</b> ↔	Frequency: 500 Hz ±50 Hz Resolution: 43,200 levels Voltage: <ul style="list-style-type: none"> <li>Low level: &lt; 0.5 V</li> <li>High level: &gt; 5.5 V</li> <li>Maximum: 6.85 V</li> </ul> Output impedance: 100 Ω Nominal temperature range: -40 to 70 °C (-40 to 158 °F) Reference temperature range: 15 to 30 °C (59 to 86 °F) Duty cycle accuracy (5 to 95 %): 0.25 % within reference temperature range 0.2 % of full scale additional error per 10 °C (18 °F) outside the reference range Example: At 70 °C (158 °F) the accuracy of the PWM output is 0.25 % + 4 × 0.2 % = 1.05 % Voltage withstand: ±30 V DC
<b>Digital inputs</b> ↔	Bipolar inputs <ul style="list-style-type: none"> <li>ON: -36 to -8 V DC, and 8 to 36 V DC</li> <li>OFF: -2 to 2 V DC</li> </ul> Minimum pulse length: 50 ms Impedance: 4.7 kΩ Voltage withstand: ±36 V DC
<b>Relay output</b> (GAM3.2 status) ↔	Relay type: Solid state Electrical rating and UL/cUL Listed: 30 V DC and 1 A, resistive Voltage withstand: ±36 V DC
<b>Relay outputs</b> ↔	Relay type: Electromechanical Electrical rating and UL/cUL Listed: 250 V AC or 30 V DC, and 6 A, resistive; B300, pilot duty (B300 is a power limit specification for inductive loads) Altitude derating from 2,000 to 4,000 m (6,562 to 13,123 ft): Maximum 150 V AC phase-to-phase Voltage withstand: 250 V AC
<b>Terminal connections</b>	<b>Frame ground and power supply</b> <ul style="list-style-type: none"> <li>Terminals: Standard 45° plug, 2.5 mm<sup>2</sup></li> <li>Wiring: 1.5 to 2.5 mm<sup>2</sup> (16 to 12 AWG), multi-stranded</li> </ul> <b>Analogue inputs, PWM, digital inputs and the status relay</b> <ul style="list-style-type: none"> <li>Terminals: Standard 45° plug, 1.5 mm<sup>2</sup></li> <li>Wiring: 0.5 to 1.5 mm<sup>2</sup> (28 to 16 AWG), multi-stranded</li> </ul> <b>Relay outputs</b> <ul style="list-style-type: none"> <li>Terminals: Standard 45° plug, 2.5 mm<sup>2</sup></li> <li>Wiring: 0.5 to 2.5 mm<sup>2</sup> (22 to 12 AWG), multi-stranded</li> </ul>
<b>Torques and terminals</b>	Module faceplate screws: 0.5 N·m (4.4 lb-in) Connection of wiring to frame ground and power supply terminals: 0.5 N·m (4.4 lb-in) Connection of wiring to analogue inputs, PWM, digital inputs, and the status relay terminals: 0.25 N·m (2.2 lb-in)

Category	Specification
	Connection of wiring to relay output terminals: 0.5 N·m (4.4 lb-in) UL/cUL Listed: Wiring must be minimum 90 °C (194 °F) copper conductors only
<b>Galvanic isolation</b>	Between power supply and other I/Os: 600 V, 50 Hz for 60 s Between analogue inputs, PWM, digital inputs, and the status relay, and other I/Os: 600 V, 50 Hz for 60 s The analogue output on terminals 5 and 6 is galvanically connected to the PWM output (terminals 6 and 7) Between relay groups and other I/Os: 2210 V, 50 Hz for 60 s
<b>Ingress protection</b>	Unmounted: No protection rating Mounted in rack: IP20 according to IEC/EN 60529
<b>Dimensions</b>	L×H×D: 28 × 162 × 150 mm (1.1 × 6.4 × 5.9 in)
<b>Weight</b>	246 g (0.5 lb)

## 2.4.8 Input/output module IOM3.1

The input output module has 4 changeover relay outputs, and 10 digital inputs. These I/Os are all configurable.

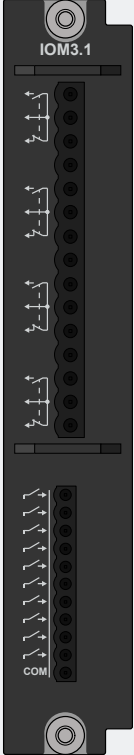
### IOM3.1 terminals

Module	Count	Symbol	Type	Name
	4		Relay output	Configurable
	10		Digital input	Configurable

### IOM3.1 technical specifications

Category	Specification
<b>Relay outputs</b> 	Relay type: Electromechanical Electrical rating and UL/cUL Listed: 250 V AC or 30 V DC, and 6 A, resistive; B300, pilot duty (B300 is a power limit specification for inductive loads) Altitude derating from 3,000 to 4,000 m (9,842 to 13,123 ft): Maximum 150 V AC phase-to-phase Voltage withstand: 250 V AC
<b>Digital inputs</b>	Bipolar inputs







Category	Specification
	<ul style="list-style-type: none"> <li>ON: -36 to -8 V DC, and 8 to 36 V DC</li> <li>OFF: -2 to 2 V DC</li> </ul> Minimum pulse length: 50 ms Impedance: 4.7 kΩ Voltage withstand: ±36 V DC
<b>Terminal connections</b>	<b>Relay outputs:</b> Terminals: Standard 45° plug, 2.5 mm <sup>2</sup> Wiring: 0.5 to 2.5 mm <sup>2</sup> (22 to 12 AWG), multi-stranded <b>Digital inputs:</b> Terminals: Standard 45° plug, 1.5 mm <sup>2</sup> Wiring: 0.1 to 1.5 mm <sup>2</sup> (28 to 16 AWG), multi-stranded
<b>Torques and terminals</b>	Module faceplate screws: 0.5 N·m (4.4 lb-in) Connection of wiring to relay output terminals: 0.5 N·m (4.4 lb-in) Connection of wiring to digital input terminals: 0.25 N·m (2.2 lb-in) UL/cUL Listed: Wiring must be minimum 90 °C (194 °F) copper conductors only
<b>Galvanic isolation</b>	Between relay groups and other I/Os: 2210 V, 50 Hz for 60 s Between digital input groups and other I/Os: 600 V, 50 Hz for 60 s
<b>Ingress protection</b>	Unmounted: No protection rating Mounted in rack: IP20 according to IEC/EN 60529
<b>Dimensions</b>	L×H×D: 28 × 162 × 150 mm (1.1 × 6.4 × 5.9 in)
<b>Weight</b>	196 g (0.4 lb)

## 2.4.9 Input/output module IOM3.2

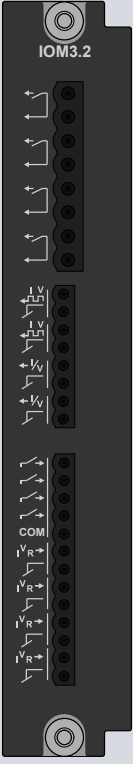



The input output module has 4 relay outputs, 4 analogue multifunctional outputs (including 2 pulse width modulation PWM outputs), 4 digital inputs, and 4 analogue multifunctional inputs. These I/Os are all configurable.

Internal cold junction compensation is not available on IOM3.2

### IOM3.2 terminals

Module	Count	Symbol	Type	Name
	4		Relay output	Configurable
	2		Analogue multifunctional output (mA, V DC, PWM)	Configurable
	2		Analogue multifunctional output (mA, V DC)	Configurable
	4		Digital input	Configurable
	4		Analogue multifunctional input (mA, V DC, RMI)	Configurable

## IOM3.2 technical specifications

Category	Specification
<b>Relay outputs</b> 	Relay type: Solidstate relay Electrical rating and UL/cUL Listed: 30 V DC, and 6 A, resistive; B300, pilot duty (B300 is a power limit specification for inductive loads) Voltage withstand: $\pm 36$ V DC
<b>Analogue multifunctional outputs</b> 	<b>Current output:</b> <ul style="list-style-type: none"> <li>• Range: Any custom range between -25 to 25 mA DC</li> <li>• Accuracy: 1 % of range</li> <li>• Resolution: 16 bits (<math>&lt; 2</math> uA / bit)</li> <li>• Type: Active output (internal supply)</li> <li>• Load: Maximum <math>\pm 25</math> mA <math>\rightarrow</math> 400 <math>\Omega</math></li> </ul> <b>Voltage output:</b> <ul style="list-style-type: none"> <li>• Range: Any custom range between -10 to 10 V DC</li> <li>• Accuracy: 1 % of range</li> <li>• Resolution: 16 bits (<math>&lt; 0,7</math> mV / bit)</li> <li>• Load: Minimum <math>\pm 10</math>V <math>\rightarrow</math> 600 <math>\Omega</math></li> <li>• Internal resistance, power ON: <math>&lt; 1</math> <math>\Omega</math></li> <li>• Internal resistance, power OFF: <math>&gt; 10</math> M<math>\Omega</math></li> </ul> <b>General information for all outputs:</b> <ul style="list-style-type: none"> <li>• Refresh rate (max): 50ms (input to output)</li> <li>• Voltage withstand: <math>\pm 36</math> V DC</li> </ul>
<b>Analogue multifunctional PWM outputs</b> 	<b>PWM output:</b> <ul style="list-style-type: none"> <li>• Frequency range: 1 to 2500 Hz <math>\pm 5</math> Hz</li> <li>• Duty cycle accuracy (5 to 95 %): 0.5 % within reference temperature range</li> <li>• Resolution: 12 bits (4096 steps)</li> <li>• Voltage: Low level: <math>&lt; 0.5</math> V. High level: <math>&gt;</math> adjustable 1 to 10 V. Maximum: 10.2 V</li> <li>• Output impedance: 25 <math>\Omega</math></li> </ul> <b>General information for all outputs:</b> <ul style="list-style-type: none"> <li>• Refresh rate (max): 50 ms (input to output)</li> <li>• Voltage withstand: <math>\pm 36</math> V DC</li> </ul>
<b>Digital inputs</b> 	<b>Negative or positive trigger inputs:</b> <ul style="list-style-type: none"> <li>• ON: -36 to -8 V DC, and 8 to 36 V DC</li> <li>• OFF: -2 to 2 V DC</li> </ul> Minimum pulse length: 50 ms Impedance: 3.9 k $\Omega$ Voltage withstand: $\pm 36$ V DC
<b>Analogue multifunctional inputs</b> 	<b>Digital inputs with wire break detection:</b> <ul style="list-style-type: none"> <li>• Dry contact inputs, 3 V DC internal supply</li> <li>• Wire-break detection with maximum resistance for ON detection: 100 <math>\Omega</math> to 400 <math>\Omega</math></li> </ul> <b>Current inputs:</b> <ul style="list-style-type: none"> <li>• From active transmitter: 0 to 20 mA, or 4 to 20 mA</li> <li>• Accuracy: <math>\pm 10</math> uA <math>\pm 0.25</math> % of actual reading</li> </ul> <b>Voltage inputs (DC):</b> <ul style="list-style-type: none"> <li>• Range: <math>\pm 10</math> V DC / 0 to 10 V DC</li> <li>• Accuracy: <math>\pm 10</math> mV <math>\pm 0.25</math> % of actual reading</li> </ul> <b>Resistance measurement inputs, 2 wire (RMI):</b> <ul style="list-style-type: none"> <li>• Resistance measurement: 0 to 4.5 k<math>\Omega</math></li> <li>• Accuracy: <math>\pm 1</math> <math>\Omega</math> <math>\pm 0.25</math> % of actual reading</li> </ul>

Category	Specification
	<p><b>Resistance measurement inputs, 1 wire (RMI):</b></p> <ul style="list-style-type: none"> <li>Resistance measurement: 0 to 4.5 k<math>\Omega</math></li> <li>Accuracy: <math>\pm 2 \Omega \pm 0.25 \%</math> of actual reading</li> </ul> <p><b>Pt100:</b></p> <ul style="list-style-type: none"> <li>Range: -200 to 850 <math>^{\circ}\text{C}</math></li> <li>Accuracy: <math>\pm 1 \text{ }^{\circ}\text{C} \pm 0.25 \%</math> of actual reading</li> </ul> <p><b>Pt1000:</b></p> <ul style="list-style-type: none"> <li>Range: -200 to 850 <math>^{\circ}\text{C}</math></li> <li>Accuracy: <math>\pm 0.5 \text{ }^{\circ}\text{C} \pm 0.25 \%</math> of actual reading</li> </ul> <p><b>Thermocouple type, range and accuracy:</b></p> <ul style="list-style-type: none"> <li>E: -200 to 1000 <math>^{\circ}\text{C}</math> ( <math>\pm 2 \text{ }^{\circ}\text{C} \pm 0.25 \%</math> of actual reading)</li> <li>J: -210 to 1200 <math>^{\circ}\text{C}</math> ( <math>\pm 2 \text{ }^{\circ}\text{C} \pm 0.25 \%</math> of actual reading)</li> <li>K: -200 to 1372 <math>^{\circ}\text{C}</math> ( <math>\pm 2 \text{ }^{\circ}\text{C} \pm 0.25 \%</math> of actual reading)</li> <li>N: -200 to 1300 <math>^{\circ}\text{C}</math> ( <math>\pm 2 \text{ }^{\circ}\text{C} \pm 0.25 \%</math> of actual reading)</li> <li>R: -50 to 1768 <math>^{\circ}\text{C}</math> ( <math>\pm 2 \text{ }^{\circ}\text{C} \pm 0.25 \%</math> of actual reading)</li> <li>S: -50 to 1768 <math>^{\circ}\text{C}</math> ( <math>\pm 2 \text{ }^{\circ}\text{C} \pm 0.25 \%</math> of actual reading)</li> <li>T: -200 to 400 <math>^{\circ}\text{C}</math> ( <math>\pm 2 \text{ }^{\circ}\text{C} \pm 0.25 \%</math> of actual reading)</li> </ul> <p><b>Note:</b> Twisted pair and shielded cable is recommended to achieve specification and optimisation of noise immunity.</p> <p><b>General information for all outputs:</b></p> <ul style="list-style-type: none"> <li>Refresh rate (max): 50 ms (input to output)</li> <li>Voltage withstand: <math>\pm 36 \text{ V DC}</math></li> <li>All analogue multi-functional inputs have a common ground</li> </ul>
<b>Terminal connections</b>	<p><b>Relay outputs:</b> Terminals: Standard 45<math>^{\circ}</math> plug, 2.5 mm<sup>2</sup> Wiring: 0.5 to 2.5 mm<sup>2</sup> (22 to 14 AWG), multi-stranded</p> <p><b>Other inputs:</b> Terminals: Standard 45<math>^{\circ}</math> plug, 1.5 mm<sup>2</sup> Wiring: 0.1 to 1.5 mm<sup>2</sup> (28 to 16 AWG), multi-stranded</p>
<b>Torques and terminals</b>	<p>Module faceplate screws: 0.5 N·m (4.4 lb-in) Connection of wiring to relay output terminals: 0.5 N·m (4.4 lb-in) Connection of wiring to digital input terminals: 0.25 N·m (2.2 lb-in) UL/cUL Listed: Wiring must be minimum 90 <math>^{\circ}\text{C}</math> (194 <math>^{\circ}\text{F}</math>) copper conductors only</p>
<b>Galvanic isolation</b>	<p>Between relay groups and other I/Os: 2210 V, 50 Hz for 60 s Between other input groups and other I/Os: 600 V, 50 Hz for 60 s</p>
<b>Ingress protection</b>	<p>Unmounted: No protection rating Mounted in rack: IP20 according to IEC/EN 60529</p>
<b>Dimensions</b>	L×H×D: 28 × 162 × 150 mm (1.1 × 6.4 × 5.9 in)
<b>Weight</b>	188 g (0.4 lb)

### 2.4.10 Input/output module IOM3.3

The input output module has 10 analogue multifunctional inputs. These I/Os are all configurable.

### IOM3.3 terminals

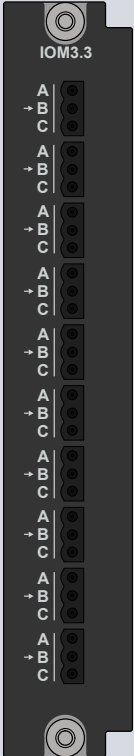
Module	Count	Symbol	Type	Name
	10	<b>A</b> <b>→ B</b> <b>C</b>	Analogue multifunctional inputs (mA, V DC, RMI)	Configurable

### IOM3.3 technical specifications



Category	Specification
<b>Analogue multifunctional inputs</b> <b>A</b> <b>→ B</b> <b>C</b>	<p><b>Digital inputs with wire break detection:</b></p> <ul style="list-style-type: none"> <li>• Dry contact inputs, 3 V DC internal supply</li> <li>• Wire-break detection with maximum resistance for ON detection: 100 Ω to 400 Ω</li> </ul> <p><b>Current inputs:</b></p> <ul style="list-style-type: none"> <li>• From active transmitter: 0 to 20 mA, or 4 to 20 mA</li> <li>• Accuracy: ±10 uA ±0.25 % of actual reading</li> </ul> <p><b>Voltage inputs (DC):</b></p> <ul style="list-style-type: none"> <li>• Range: ±10 V DC / 0 to 10 V DC</li> <li>• Accuracy: ±10 mA ±0.25 % of actual reading</li> </ul> <p><b>Resistance measurement inputs, 2 or 3 wire (RMI):</b></p> <ul style="list-style-type: none"> <li>• Resistance measurement: 0 to 4.5 kΩ</li> <li>• Accuracy: ±1 Ω ±0.25 % of actual reading</li> </ul> <p><b>Resistance measurement inputs, 1 wire (RMI):</b></p> <ul style="list-style-type: none"> <li>• Resistance measurement: 0 to 4.5 kΩ</li> <li>• Accuracy: ±2 Ω ±0.25 % of actual reading</li> </ul> <p><b>Pt100:</b></p> <ul style="list-style-type: none"> <li>• Range: -200 to 850 °C</li> <li>• Accuracy: ±1 °C ±0.25 % of actual reading</li> </ul> <p><b>Pt1000:</b></p> <ul style="list-style-type: none"> <li>• Range: -200 to 850 °C</li> <li>• Accuracy: ±0.5 °C ±0.25 % of actual reading</li> </ul> <p><b>Thermocouple type, range and accuracy:</b></p> <ul style="list-style-type: none"> <li>• E: -200 to 1000 °C ( ±2 °C ±0.25 % of actual reading)</li> <li>• J: -210 to 1200 °C ( ±2 °C ±0.25 % of actual reading)</li> </ul>

Category	Specification
	<ul style="list-style-type: none"> <li>• K: -200 to 1372 °C ( ±2 °C ±0.25 % of actual reading)</li> <li>• N: -200 to 1300 °C ( ±2 °C ±0.25 % of actual reading)</li> <li>• R: -50 to 1768 °C ( ±2 °C ±0.25 % of actual reading)</li> <li>• S: -50 to 1768 °C ( ±2 °C ±0.25 % of actual reading)</li> <li>• T: -200 to 400 °C ( ±2 °C ±0.25 % of actual reading)</li> </ul> <p><b>Note:</b> Twisted pair and shielded cable is recommended to achieve specification and optimisation of noise immunity.</p> <p><b>General information for all inputs:</b></p> <ul style="list-style-type: none"> <li>• Voltage withstand: ±36 V DC</li> </ul>
<b>Internal cold junction compensation (CJC)</b>	<p><b>Internal temperature sensor:</b></p> <ul style="list-style-type: none"> <li>• Range: 0 to 70 °C <ul style="list-style-type: none"> <li>◦ Accuracy: ±1.0 °C</li> </ul> </li> <li>• Range: -40 to 0 °C <ul style="list-style-type: none"> <li>◦ Accuracy: ±2.0 °C</li> </ul> </li> </ul> <p><b>Mathematical compensation:</b></p> <ul style="list-style-type: none"> <li>• If non channels are configured as 4-20 mA <ul style="list-style-type: none"> <li>◦ Accuracy: ±1.0 °C</li> </ul> </li> <li>• If any channels are configured as 4-20 mA <ul style="list-style-type: none"> <li>◦ Accuracy: ±1.5 °C</li> </ul> </li> </ul> <p>If it is needed to have 4-20 mA channels on the same card, it is recommended to use the top channels for 4-20 mA and the lower channels for TC's</p> <p><b>Internal cold junction accuracy:</b></p> <ul style="list-style-type: none"> <li>• Heat dissipated by nearby heat sources can cause errors in thermocouple measurements by heating the IOM3.3 terminals to a different temperature than the cold-junction compensation sensor. Thermal gradient across the terminals can cause the terminals of different IOM3.3 channels to be at different temperatures, which creates accuracy errors and affects the relative accuracy between channels.</li> <li>• The temperature measurement accuracy specifications include errors caused by the thermal gradient across the IOM3.3 terminals for configurations with the IOM3.3 terminals facing forward or upward.</li> </ul>
<b>Terminal connections</b>	<p>Terminals: Standard 45° plug, 1.5 mm<sup>2</sup></p> <p>Wiring: 0.1 to 1.5 mm<sup>2</sup> (28 to 16 AWG), multi-stranded</p>
<b>Torques and terminals</b>	<p>Module faceplate screws: 0.5 N·m (4.4 lb-in)</p> <p>Connection of wiring to relay output terminals: 0.5 N·m (4.4 lb-in)</p> <p>Connection of wiring to input terminals: 0.25 N·m (2.2 lb-in)</p> <p>UL/cUL Listed: Wiring must be minimum 90 °C (194 °F) copper conductors only</p>
<b>Galvanic isolation</b>	<p>All 10 multi inputs have a common ground</p> <p>Galvanic isolation from rack: 600 V, 50 Hz for 60 s</p>
<b>Dimensions</b>	L×H×D: 28 × 162 × 150 mm (1.1 × 6.4 × 5.9 in)
<b>Weight</b>	164 g (0.4 lb)

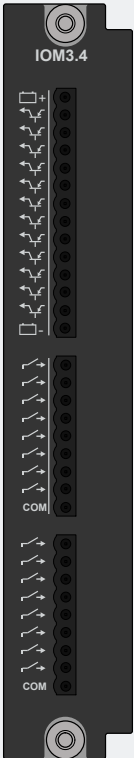

### 2.4.11 Input/output module IOM3.4

The input output module has 12 digital outputs, and 16 digital inputs. These I/Os are all configurable.

### IOM3.4 terminals

Module	Count	Symbol	Type	Name
	12		Digital output	Configurable
	16		Digital input	Configurable

### IOM3.4 technical specifications

Category	Specification
<b>Digital outputs</b> 	Transistor type: PNP Supply voltage: 12 or 24 V DC nominal, maximum 36 V DC (relative to common) Maximum current (per output): < 55 °C: 250 mA; > 55 °C: 200 mA Leak current: Typical 1 µA, maximum 100 µA (temperature-dependent) Saturation voltage: Maximum 0.5 V Non-replaceable 4 A fuse Voltage withstand: ±36 V DC Load dump protected by TVS diodes Short circuit protection Reverse polarity protection Internal freewheeling diode
<b>Digital inputs</b> 	Bipolar inputs <ul style="list-style-type: none"> <li>ON: -36 to -8 V DC, and 8 to 36 V DC</li> <li>OFF: -2 to 2 V DC</li> </ul> Minimum pulse length: 50 ms Impedance: 4.7 kΩ Voltage withstand: ±36 V DC
<b>Terminal connections</b>	Terminals: Standard 45° plug, 1.5 mm <sup>2</sup> Wiring: 0.1 to 1.5 mm <sup>2</sup> (28 to 16 AWG), multi-stranded
<b>Torques and terminals</b>	Module faceplate screws: 0.5 N·m (4.4 lb-in) Connection of wiring to terminals: 0.25 N·m (2.2 lb-in) UL/cUL Listed: Wiring must be minimum 90 °C (194 °F) copper conductors only
<b>Galvanic isolation</b>	Between groups: 600 V, 50 Hz for 60 s
<b>Ingress protection</b>	Unmounted: No protection rating Mounted in rack: IP20 according to IEC/EN 60529

Category	Specification
Dimensions	L×H×D: 28 × 162 × 150 mm (1.1 × 6.4 × 5.9 in)
Weight	175 g (0.4 lb)

## 2.4.12 Processor and communication module PCM3.3

The processor and communication module has the controller's main microprocessor, which contains and runs the controller application software. It includes the Ethernet switch to manage the controller Ethernet connections. It has a *Self-check OK*

LED. PCM3.3 has 4 x CAN ports and 1 x RS-232/485 port and 1 x RS-485 port for serial bus connectivity. It has DisplayPort and USB (Type A) ports for connection and control with a display.

By default the module is provided with screw terminals.

### PCM3.3 terminals

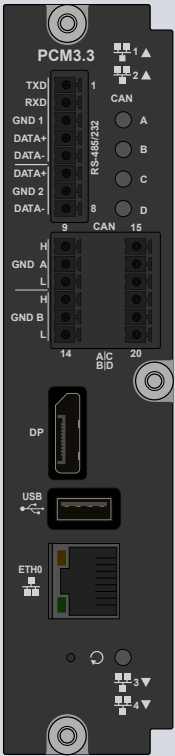
Module	Count	Symbol	LED	Type	Name
	5	ETH0 1 to 4	<ul style="list-style-type: none"> <li>Off : No communication</li> <li>Green : Communication connected</li> <li>Green flash : Active communication</li> </ul>	Ethernet (RJ45)	Two connections at the top of the hardware module, one on the front, and two at the bottom.
	1	Self-check OK	<ul style="list-style-type: none"> <li>Off : Self-check not OK</li> <li>Green : Self-check OK</li> <li>Red : All alarms acknowledged</li> <li>Red flash : Unacknowledged alarms</li> </ul>		
	1	USB		USB host (Type-A)	
	1	DP		DisplayPort (DP full size)	
	4	H, GND A to D, L	<ul style="list-style-type: none"> <li>Off : No communication</li> <li>Green : CAN connected</li> </ul>	CAN port	CAN bus
	1	COM 1		RS-232/485 port	
	1	COM 2		RS-485 port	

### PCM3.3 technical specifications

Power supply and backplane	
Power supply	From backplane via PSM3.x module.

Interfaces	
Ethernet	1 x Ethernet (ETH 0). 4 x Ethernet, Managed Switch (ETH 1 to 4)
CAN	4 x CAN (CAN 1 to 4)
UART	<b>COM 1 and COM 2:</b> 2(1) x RS-485 (COM 1, COM 2) <b>COM 1 only:</b> 1 x RS-232 (COM 1)
DisplayPort	1 x DisplayPort(DP) 1.3 1080p (Full-size connector).

Interfaces	
USB Host	1x USB 3.0 ( Type-A connector )
LED	See terminals.
Pin-hole switch	Factory Reset

CPU	
Processor	1.6 GHz Quad-core.
Real-Time Clock (RTC) battery	Real time clock with replaceable coin-cell battery.
Other features	CPU junction temperature measurement. Software reset on high CPU temperature.

Other	
Dimensions	L×H×D: 36.8 × 162 × 142 mm (1.44 × 6.37 × 5.59 in)
Weight	~ 226 g (0.49 lb)
Power consumption	~ 16 W, hereof 5.6 W reserved for USB3.0 host
Torques and terminals	Module faceplate screws: 0.5 N·m (4.4 lb-in). Connection of wiring to terminals: 0.5 N·m (4.4 lb-in). UL/ULC Listed: Wiring must be minimum 90 °C (194 °F) copper conductors only.
Ingress protection	<b>Unmounted:</b> No protection rating <b>Mounted in rack:</b> IP20 according to IEC/EN 60529

### 2.4.13 Blind module

A blind module must be used to close off each empty slot in the rack.

#### Blind module technical specifications

Category	Specification
Tightening torque	Module faceplate screws: 0.5 N·m (4.4 lb-in)
Dimensions	L×H×D: 28 × 162 × 18 mm (1.1 × 6.4 × 0.7 in)
Weight	44 g (0.1 lb)

### 2.4.14 Small blind module

A small blind module is required for extension racks.

#### Small blind module technical specifications

Category	Specification
Tightening torque	Module faceplate screws: 0.5 N·m (4.4 lb-in)
Size	L×H×D: 14 × 162 × 18 mm (0.5 × 6.4 × 0.7 in)
Weight	12 g (0.03 lb)

## 2.5 Controller or extension racks

### 2.5.1 Rack R4.1

Category	Specification
Ingress protection	IP20 (all slots must have modules or blind modules mounted) according to IEC/EN 60529
UL/cUL Listed	Type Complete Device, Open Type 1
Material	Rack frame: Aluminium
Mounting	Base mount, using four M6 bolts with self-locking washers (or self-locking screws). The bolts and self-locking washers (or self-locking screws) are not included with the rack. UL/cUL Listed: For use on a flat surface of a type 1 enclosure UL/cUL Listed: To be installed in accordance with the NEC (US) or the CEC (Canada)
Tightening torque	Mounting bolts: 4 N·m (35 lb-in)

### 2.5.2 Rack R7.1

Category	Specification
Ingress protection	IP20 (all slots must have modules or blind modules mounted) according to IEC/EN 60529
UL/cUL Listed	Type Complete Device, Open Type 1
Material	Rack frame: Aluminium
Mounting	Base mount, using four M6 bolts with self-locking washers (or self-locking screws). The bolts and self-locking washers (or self-locking screws) are not included with the rack. UL/cUL Listed: For use on a flat surface of a type 1 enclosure UL/cUL Listed: To be installed in accordance with the NEC (US) or the CEC (Canada)
Tightening torque	Mounting bolts: 4 N·m (35 lb-in)

## 2.6 iE 7 display

### 2.6.1 Terminal connections

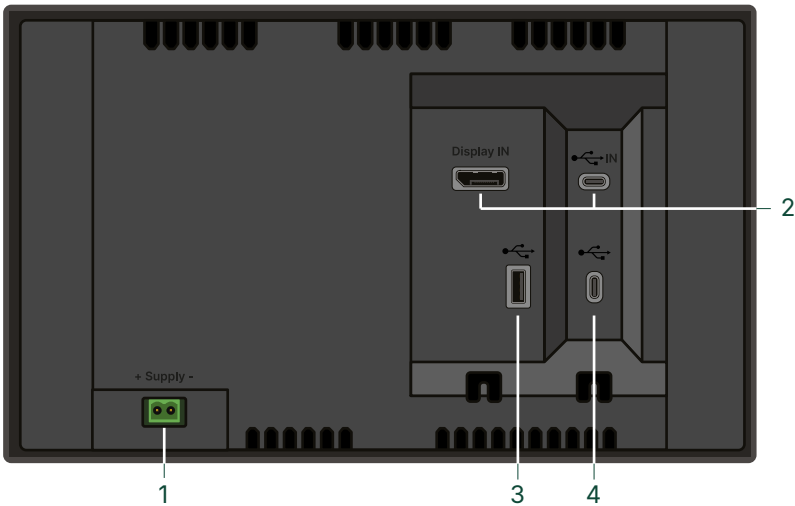

No.	Function	Notes
1	Power supply	1 Power supply (DC+/-)
2	DisplayPort USB IN	Connection to base-mounted controller. USB 2.0 host (type C)
3	USB	USB 2.0 host (type A)
4	USB	USB 2.0 host (type C)

### 2.6.2 Electrical specifications

Power supply	
Input voltage	Nominal voltage: 12 V DC or 24 V DC (Operation range: 6.5 to 36 V DC) Power up at 8 V Operation down to 6.5 V at 15 W Operation down to 6.9 V at 28 W
Voltage withstand	Reverse polarity
Power supply drop-out immunity	0 V DC for 50 ms (coming from more than 6.5 V DC) at 15 W
Power supply load dump protection	Load dump protected according to ISO16750-2 test A
Power consumption	15 W typical 28 W maximum

Battery voltage measurement	
Accuracy	$\pm 0.8$ V within 8 to 32 V DC, $\pm 0.5$ V within 8 to 32 V DC @ 20 °C

### 2.6.3 Communication specifications

Communication specifications	
DisplayPort *	Connection to base-mounted controller.
USB IN *	Connection to base-mounted controller. USB 2.0 (type C).

**Communication specifications**

<b>USB hub Type A</b>	For future use.
<b>USB hub Type C</b>	For future use.

**NOTE** \* Both DisplayPort and USB IN are required for communication and control to the controller.

## 2.7 Accessories

### 2.7.1 USB type A to C cable

The USB cable is necessary for control between the display and base-mounted controller.

This is supplied with the iE 7 display.

Category	Specification
Cable type	USB type A to type C cable.
USB	USB 2.0
Length	3.0 m (9.85 ft)

### 2.7.2 DisplayPort cable

The DisplayPort cable is necessary for visual HMI between the display and base-mounted controller.

This is supplied with the iE 7 display.

Category	Specification
Cable type	VESA DisplayPort compliant cable.
Length	3.0 m (9.85 ft)

### 2.7.3 Ethernet cable

The Ethernet cable from DEIF meets the technical specifications below.

Category	Specification
Cable type	Shielded patch cable SF/UTP CAT5e
Temperature	Fixed installation: -40 to 80 °C (-40 to 176 °F) Flexible installation: -20 to 80 °C (-4 to 176 °F)
Minimum bending radius (recommended)	Fixed installation: 25 mm (1 in) Flexible installation: 50 mm (2 in)
Length	2 m (6.6 ft)
Weight	~110 g (4 oz)

## 2.8 Approvals

Standards
CE
UKCA

Marine certificates	Cybersecurity IACS UR E27
ABS	Yes
BV	Yes
DNV	Yes
LR	Yes

**More information**

See Approvals/certifications for the most recent certificates [www.deif.com/documentation/ie-350-marine/](http://www.deif.com/documentation/ie-350-marine/).

## 2.9 Cybersecurity

Category	Specification
Cybersecurity	Certified to IACS UR E27 *

**NOTE** \* Connections to untrusted networks may require additional equipment or security counter-measures not included in the product.

## 3. Legal information

### 3.1 Disclaimer and copyright

#### Open source software

This product contains open source software licensed under, for example, the GNU General Public License (GNU GPL) and GNU Lesser General Public License (GNU LGPL). The source code for this software can be obtained by contacting DEIF at support@deif.com. DEIF reserves the right to charge for the cost of the service.

#### General warranty

The warranty period for the purchased product is defined in the contract and order acknowledgement. In general, DEIF's Terms and Conditions of Sale and Delivery apply.

The product continuously monitors the operating temperature and stores this information in a log file on the device. DEIF uses this information for service purpose and to validate if issues with the product are covered by the warranty.

The software packages supplied are believed to be of the highest quality. Due to the nature of the software development process, it is possible that there are hidden defects in the software which may affect its use, or the operation of any software or device developed with this software package.

DEIF does not undertake responsibility for determining whether this package is suitable for the application, nor for ensuring the correct operation of the application software and hardware.

The warranty does not cover product wear parts, such as:

- Internal flash disc
- If applicable, SD card (purchased separately)
- Replaceable coil-cell battery, used for the real-time clock (available as a spare part)

#### Trademarks

DEIF and the DEIF logo are trademarks of DEIF A/S.

BELDEN is a trademark of BELDEN INC.

Bonjour® is a registered trademark of Apple Inc. in the United States and other countries.

Adobe®, Acrobat®, and Reader® are either registered trademarks or trademarks of Adobe Systems Incorporated in the United States and/or other countries.

CANopen® is a registered community trademark of CAN in Automation e.V. (CiA).

SAE J1939® is a registered trademark of SAE International®.

CODESYS® is a trademark of CODESYS GmbH.

EtherCAT®, EtherCAT P®, Safety over EtherCAT®, are trademarks or registered trademarks, licensed by Beckhoff Automation GmbH, Germany.

VESA® and DisplayPort® are registered trademarks of Video Electronics Standards Association (VESA®) in the United States and other countries.

Modbus® is a registered trademark of Schneider Automation Inc.

Torx®, Torx Plus® are trademarks or registered trademarks of Acument Intellectual Properties, LLC in the United States or other countries.

Windows® is a registered trademark of Microsoft Corporation in the United States and other countries.

All trademarks are the properties of their respective owners.

#### Copyright

© Copyright DEIF A/S. All rights reserved.

## **Disclaimer**

DEIF A/S reserves the right to change any of the contents of this document without prior notice.

The English version of this document always contains the most recent and up-to-date information about the product. DEIF does not take responsibility for the accuracy of translations, and translations might not be updated at the same time as the English document. If there is a discrepancy, the English version prevails.