

PICUS

PC Utility software

User's manual

4189341362-1



Improve
Tomorrow



1. About the PICUS manual	
1.1 Intended users of the PICUS manual.....	6
1.2 Need more information?.....	6
1.3 Software version.....	6
1.4 Symbols and notation.....	6
1.5 Safety during operation.....	7
1.6 Broadcast settings.....	8
1.7 Legal information.....	8
2. Getting started with PICUS	
2.1 Introduction to PICUS.....	9
2.2 System requirements.....	9
2.3 Download and install.....	9
2.4 Ethernet connection.....	10
2.5 Supported DEIF products.....	11
2.6 Launch PICUS.....	12
2.7 Screen layout.....	13
2.7.1 Notifications.....	14
2.8 Command sources.....	14
3. Connect	
3.1 Connect page.....	15
3.1.1 Open offline project file.....	16
3.1.2 Convert.....	16
3.1.3 Connect host.....	17
3.1.4 Initial download (Initial DL).....	17
3.2 Versions page.....	18
3.2.1 Differences.....	19
4. Live data	
4.1 Live data page.....	20
5. Application	
5.1 About Application.....	21
5.2 Supervision page.....	22
5.2.1 Default theme colours.....	22
5.2.2 Change mode.....	23
5.2.3 Start or stop equipment.....	23
5.2.4 Close or open the breaker.....	23
5.2.5 Input/output information.....	24
5.3 Emulation page.....	25
5.3.1 Default theme colours.....	25
5.3.2 Change mode.....	26
5.3.3 Start or stop equipment.....	26
5.3.4 Close or open the breaker.....	26
5.3.5 Input/output information.....	27
5.3.6 Simulate events.....	28
5.4 Configuration page.....	29
5.4.1 Add or remove equipment.....	30
5.4.2 Add or remove connections.....	30
5.4.3 Configure equipment.....	31
5.4.4 Group or ungroup equipment.....	31

5.4.5 Add a ring busbar connection.....	32
5.4.6 Configure breaker under-voltage coil.....	33
5.4.7 Add QuickConnect (GPC 300).....	33
5.4.8 Broadcast application to controllers.....	34
5.4.9 Create or edit themes.....	35
6. Alarms	
6.1 About the alarms.....	36
6.1.1 Alarm flowchart.....	37
6.1.2 Alarm states.....	38
6.2 Alarms page.....	39
6.2.1 Alarm handling and actions.....	40
6.2.2 Latched alarms.....	41
6.2.3 Alarm tests.....	41
6.2.4 Shelved alarms.....	42
6.2.5 Remove from service.....	44
7. Log	
7.1 Log page.....	45
7.2 DM2 Log page.....	46
8. I/O status	
8.1 I/O status page.....	47
9. Tools	
9.1 Settings.....	48
9.1.1 Settings page.....	48
9.2 Permissions (iE 250/iE 350).....	49
9.2.1 About permissions.....	49
9.2.2 Role management.....	50
9.2.3 Users page.....	51
9.3 Permissions (GPU/GPC/PPU/PPM).....	52
9.3.1 About permissions.....	52
9.3.2 Groups page.....	53
9.3.3 Manage groups.....	54
9.3.4 Users page.....	55
9.3.5 Manage users.....	56
9.4 Backup.....	57
9.4.1 About backup.....	57
9.4.2 Backup page.....	58
9.4.3 Create full backup.....	59
9.4.4 Partial backup page.....	60
9.4.5 Create partial backup.....	61
9.4.6 Manage backups page.....	63
9.4.7 Delete backup.....	64
9.5 Restore configuration.....	65
9.5.1 About restore configuration.....	65
9.5.2 Restore configuration constraints.....	65
9.5.3 Restore configuration page.....	66
9.5.4 Broadcast or restore a configuration.....	67
9.6 Restore.....	68
9.6.1 About restore.....	68

9.6.2 Restore constraints.....	68
9.6.3 Restore page.....	70
9.6.4 Restore a backup.....	71
9.7 Firmware.....	72
9.7.1 About firmware.....	72
9.7.2 Firmware constraints.....	72
9.7.3 Update controller page.....	73
9.7.4 Update display page (GPU/GPC/PPU/PPM).....	74
9.7.5 Install firmware.....	75
9.8 Trending.....	76
9.8.1 Record page.....	76
9.8.2 Recordings page.....	77
9.9 Regulator status.....	78
9.9.1 Regulator status page.....	78
9.10 Report.....	79
9.10.1 Report page.....	79
9.10.2 Report preview page.....	80
10. Configure	
10.1 Parameters.....	81
10.1.1 Parameters page.....	81
10.1.2 Parameter curve page.....	83
10.1.3 Review changes.....	84
10.1.4 Write changes or all.....	84
10.1.5 Reset counter.....	85
10.1.6 Alarm test.....	85
10.2 Input/output.....	86
10.2.1 About input or output channels.....	86
10.2.2 I/O configuration.....	87
10.3 Display designer.....	88
10.3.1 About Display designer.....	88
10.3.2 Display designer.....	89
10.3.3 Header designer.....	90
10.3.4 Indicator widget.....	91
10.4 CustomLogic.....	92
10.4.1 About CustomLogic.....	92
10.4.2 CustomLogic constraints.....	93
10.4.3 Project overview page.....	94
10.4.4 Element setup page.....	95
10.4.5 Monitor page.....	96
10.4.6 Elements and functions.....	97
10.4.7 Function blocks.....	99
10.4.8 Configure a CustomLogic project.....	100
10.4.9 Logic gate examples.....	102
10.5 Modbus.....	105
10.5.1 Protocols page.....	105
10.5.2 Create, edit, or export a protocol.....	106
10.5.3 Conversions page.....	109
10.5.4 Create or edit a conversion.....	110
10.5.5 Servers page.....	111

10.5.6 Create or edit a server.....	112
10.6 Counters.....	113
10.6.1 About Counters.....	113
10.6.2 Counters page.....	114
10.7 Fieldbus configuration.....	115
10.7.1 About Fieldbus.....	115
10.7.2 Fieldbus configuration page.....	116
10.7.3 Detect setup.....	117
10.7.4 Add extension racks.....	117
10.7.5 Add an ECU.....	117
10.7.6 Add a DVAR.....	118
10.7.7 Configure fieldbus.....	118
10.8 Fieldbus supervision.....	120
10.8.1 Fieldbus supervision page.....	120
10.8.2 Identify hardware.....	120
10.9 Time settings.....	121
10.9.1 About Time settings.....	121
10.9.2 Time settings page.....	122
10.10 Communication.....	123
10.10.1 About communication.....	123
10.10.2 Communication - Ethernet settings.....	124
10.10.3 Communication - Port settings.....	125
10.10.4 Identify controller.....	126
10.10.5 Configure communication settings.....	126
11. Information	
11.1 About page.....	128
12. Troubleshooting	
12.1 Troubleshooting.....	129

1. About the PICUS manual

1.1 Intended users of the PICUS manual

The PICUS manual is intended for designers and operators who need to configure or supervise the system.

1.2 Need more information?

Get direct access to the resources you need by using the links below.



Official DEIF homepage.

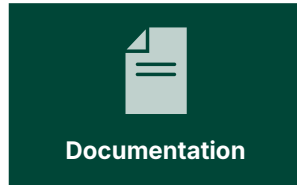

See all the related documentation.



Self-help resources and how to contact DEIF for assistance.



Download the latest software.



PICUS page.

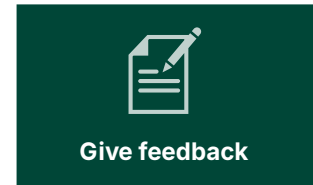

Let us have your feedback on our documentation.

1.3 Software version

The information in this document relates to software version 1.0.26.x.

Not all features shown in this document are supported on all products.

1.4 Symbols and notation

Symbols for general notes

NOTE This shows general information.



More information

This shows where you can find more information.



Example

This shows an example.



How to ...

This shows a link to a video for help and guidance.

Symbols for hazard statements



DANGER!



This shows dangerous situations.

If the guidelines are not followed, these situations will result in death, serious personal injury, and equipment damage or destruction.



WARNING



This shows potentially dangerous situations.

If the guidelines are not followed, these situations could result in death, serious personal injury, and equipment damage or destruction.



CAUTION



This shows low level risk situation.

If the guidelines are not followed, these situations could result in minor or moderate injury.

NOTICE



This shows an important notice

Make sure to read this information.

1.5 Safety during operation

PICUS is a tool used to design, emulate, commission, and service the controller system.

NOTICE



Change of configuration during operation

Configuration changes during operation may not be permitted by some Maritime classification societies. PICUS does not include all the safeguards required by the Maritime class societies.

It is possible to connect several PCs running PICUS to the system at the same time. Make sure that a controller does not receive conflicting information from PICUS and/or the display units at the same time, especially when you commission and service the system.

Concurrent configurations

If two concurrent configuration changes are made from PICUS and the display at the same time, only the **last** change the controller receives is implemented. The controller does not give a message about the change it ignores.

Concurrent commands

If two concurrent commands are sent from two different computers at the same time, only the **first** command the controller receives is effective. The controller gives a message about the command it does not execute.

1.6 Broadcast settings

Some settings can be broadcasted () to other controllers in the system:

- Application
- Restore configuration

NOTICE



Broadcast with override status

The broadcast from PICUS can override the controller status if required by the user. In this case, PICUS will NOT check that they are ready for commissioning. It is the customer's responsibility to ensure that all of the controllers are not operating any connected equipment, such as a genset, when broadcasting information that could change the configuration.

1.7 Legal information

Disclaimer

DEIF takes no responsibility for the installation or operation of the **genset**. Contact the **genset company** if you have any doubt about how to install or operate the genset.

DEIF A/S reserves the right to change any of the contents of this document without prior notice.

The English version of this document always contains the most recent and up-to-date information about the product. DEIF does not take responsibility for the accuracy of translations, and translations might not be updated at the same time as the English document. If there is a discrepancy, the English version prevails.

Open source software

This product contains open source software licensed under, for example, the GNU General Public License (GNU GPL) and GNU Lesser General Public License (GNU LGPL). Contact DEIF at support@deif.com if you need the source code for this software. DEIF reserves the right to charge for the cost of the service.

Trademarks

DEIF and the DEIF logo are trademarks of DEIF A/S.

Bonjour[®] is a registered trademark of Apple Inc. in the United States and other countries.

CANopen[®] is a registered community trademark of CAN in Automation e.V. (CiA).

CODESYS[®] is a trademark of 3S-Smart Software Solutions GmbH.

EtherCAT[®], *EtherCAT P*[®], *Safety over EtherCAT*[®], are trademarks or registered trademarks, licensed by Beckhoff Automation GmbH, Germany.

Modbus[®] is a registered trademark of Schneider Automation Inc.

Windows[®] is a registered trademark of Microsoft Corporation in the United States and other countries.

All trademarks are the properties of their respective owners.

Copyright

© Copyright DEIF A/S. All rights reserved.

2. Getting started with PICUS

2.1 Introduction to PICUS



PICUS is the PC utility software to configure, commission, and supervise DEIF controllers.



More information

See <https://www.deif.com/products/picus/> for the latest information and software downloads.

Regional settings

PICUS uses your computer's regional settings for both display and entry of numeric and character values. All default values are using the English (UK) regional setting.

Your local settings may be different. To avoid configuration errors, check your regional settings before configuring any values.

Some special characters may not be supported by PICUS.

Sleep mode

If your computer switches to **Sleep mode** while running PICUS, you might lose connection to the controllers.

2.2 System requirements

PICUS requirements

Component	Requirements	Notes
Operation system	Windows version 7, 8.1 Professional or 10	Service pack 1 or above
Free disk space	<ul style="list-style-type: none">2 GB or more of free disk space	
Memory	Minimum 2 GB RAM	On complex systems additionally memory is recommended
Network interface	Network adaptor with 1 free Ethernet port	To connect your computer to the controller
Screen resolution	Minimum 1024 x 768 pixels	
Browser	<ul style="list-style-type: none">EdgeMozilla Firefox 10.x or laterApple Safari 5Google Chrome 17.x	
PDF reader	Acrobat Reader 8.0 or higher	To read PDF report

NOTE Due to the way that Windows allows access to network files and folders, it may not be possible to access these with PICUS. Open the files and save them locally on your computer. This applies for firmware updates and backup files.

2.3 Download and install

Download

You can download PICUS for free directly from the DEIF homepage:

<https://www.deif.com/software/?product=28998>

Install PICUS

Close all other applications before you install PICUS. Close any active version, before you reinstall PICUS.

1. Launch the PICUS installer from your computer:

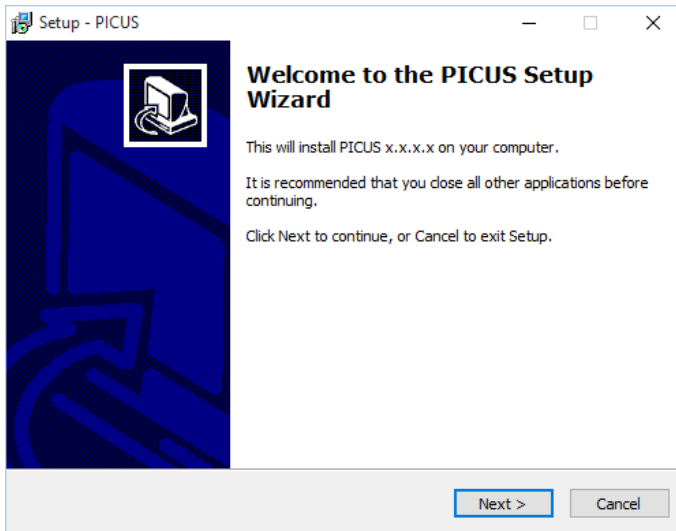

-
- 2. To continue the installation, select `Next >` .
- 3. Confirm the installation location, select `Next >` .
 - You can change the default installed location if required.
- 4. Confirm the shortcut location, select `Next >` .
- 5. Confirm adding a desktop shortcut, select `Next >` .
- 6. To start the installation, select `Install`.

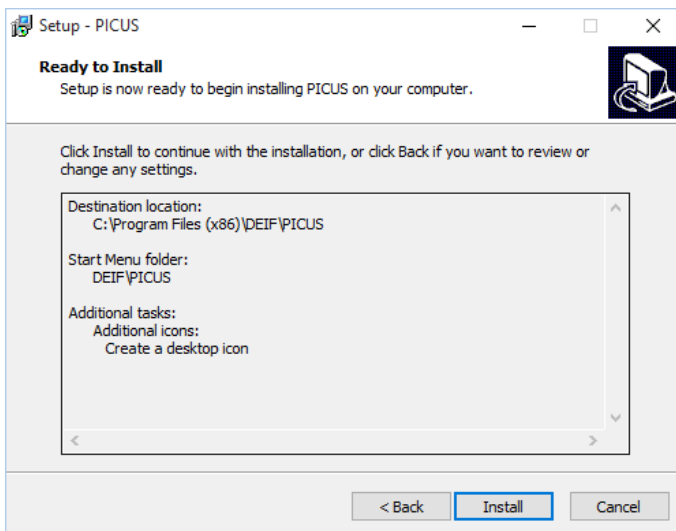

-
- 7. After PICUS is installed, select `Finish` to complete the installation.

2.4 Ethernet connection

PICUS connects to the controllers with an Ethernet connection.

You can connect PICUS with either:

- A direct Ethernet cable to the controller port (recommended).
- An in-direct Ethernet connection over the same Ethernet network.

We recommend a direct connection from your computer to the controller service port. The port on the controller must be configured as either **Automatic** or **External network/PICUS**.

For iE 250

Controller

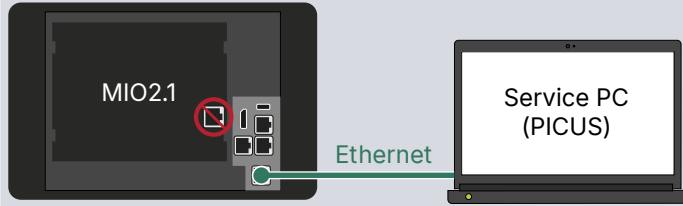

Connect an Ethernet cable to the service PC port on the controller.

Do **not** use the EtherCAT port on the MIO2.1 module. This is for connection to expansion racks and is **not** to connect your computer.

For Multi-line 300 (GPU/GPC/PPU/PPM)

Controller

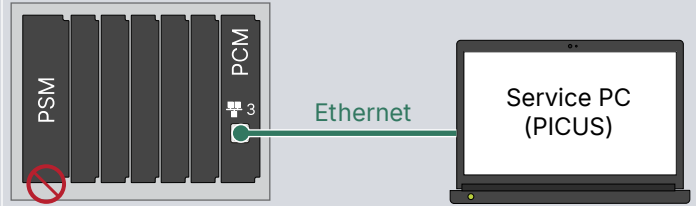

Connect an Ethernet cable to the PCM module in the controller rack. We recommend that you use port 3, as this is easy to access.

Do **not** use the red internal communication (EtherCAT) ports on the PSM module. These are for connection to expansion racks and are **not** to connect your computer.

All controllers in the same system communicate with each other over the **DEIF Ethernet network**. You only need to connect your Ethernet cable to any one of the controllers, so that you can log on to any controller.



More information

See [Communication](#) for how to configure the communication settings in PICUS.



More information

If you cannot see any controllers on the Connect page, see [Troubleshooting](#) for assistance.

2.5 Supported DEIF products

PICUS is compatible with the following DEIF controllers:

- [iE 250](#)
- [iE 250 Marine](#)
- [iE 350](#)
- [iE 350 Marine](#)
- [GPU 300](#)
- [GPC 300](#)
- [PPU 300](#)
- [PPM 300](#)

Not all features shown in this manual are supported on all products.

2.6 Launch PICUS

Launch PICUS from the installed folder or from the desktop icon .

You can launch one or more PICUS applications at the same time on the same computer, if you need to work or supervise different controllers at the same time.

Windows security alert

You may need to confirm a Windows security alert, if your computer security level requires it. When you install PICUS for the first time, you may also need to confirm your access rights to the PICUS web socket server:

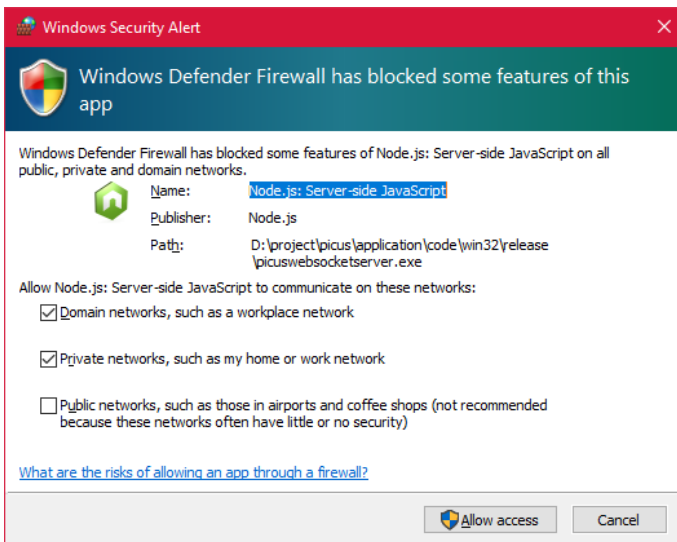

Select  **Allow access.**

2.7 Screen layout

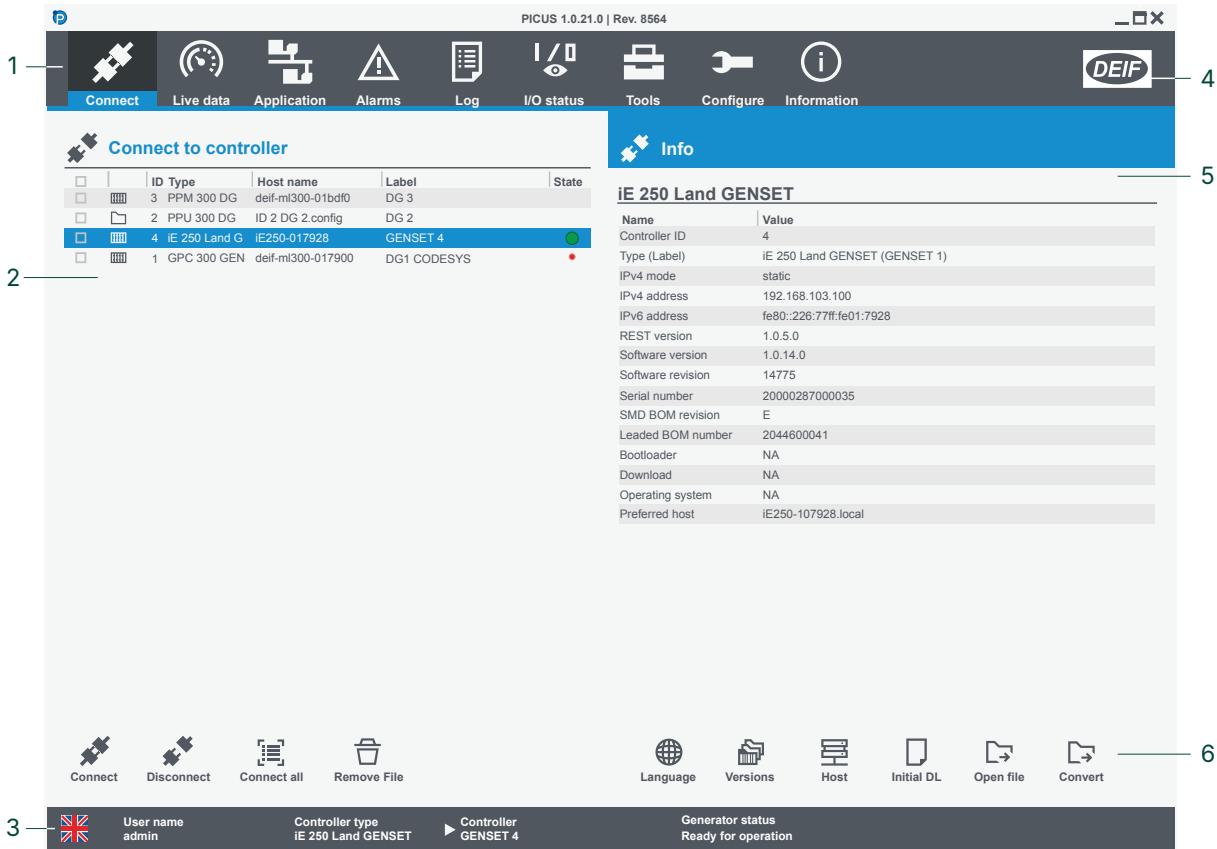

No.	Item	Notes
1	Page menu *	Selects a page to display.
2	Page content	Content for the selected page.
3	Status bar	System information for the connected controller and user.
4	 About information	Information about PICUS and the controller software.
5	Additional page content	Additional information for the selected page.
6	Actions	Actions and additional features for the selected page.

NOTE * These pages can be restricted by [User permissions](#).

2.7.1 Notifications

You are advised about events as they occur with notification windows.

Quick notifications

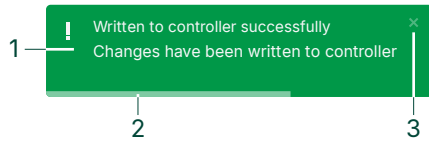

1. Quick notification details.
2. Delay timer before automatic closure.
3. Close the notification window.

Information notifications

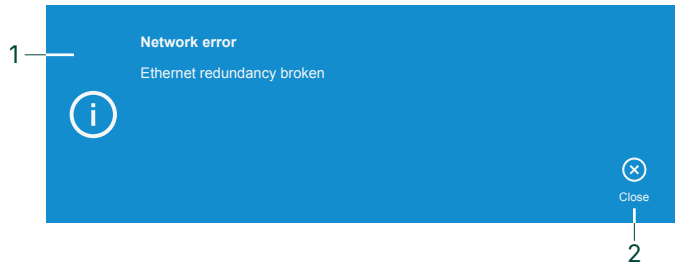

1. Information details.
2. Close (x) the notification window.

Alarm notifications

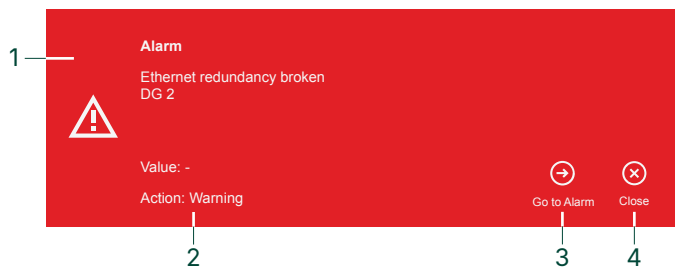

1. Description of the alarm.
2. Value and action for the alarm.
3. Go to alarm (→) page to view the alarm(s).
4. Close (x) the notification window.

Message notifications

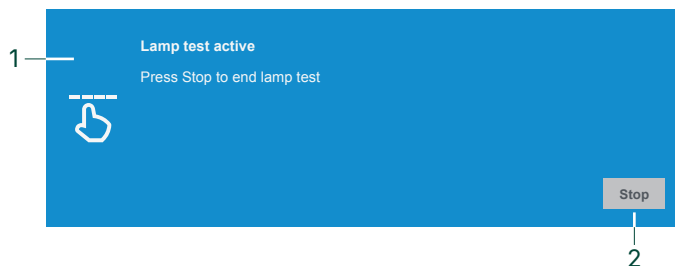

1. Message details.
2. Example, press **Stop** to end the action and close the message window.

2.8 Command sources

Certain command sources can be restricted from use. For example, you could restrict the Supervision function for start/stop of the engine. Check with the designer of the system.



More information

See **Command sources** in the **Designer's handbook** for how to configure these settings.

3. Connect

3.1 Connect page

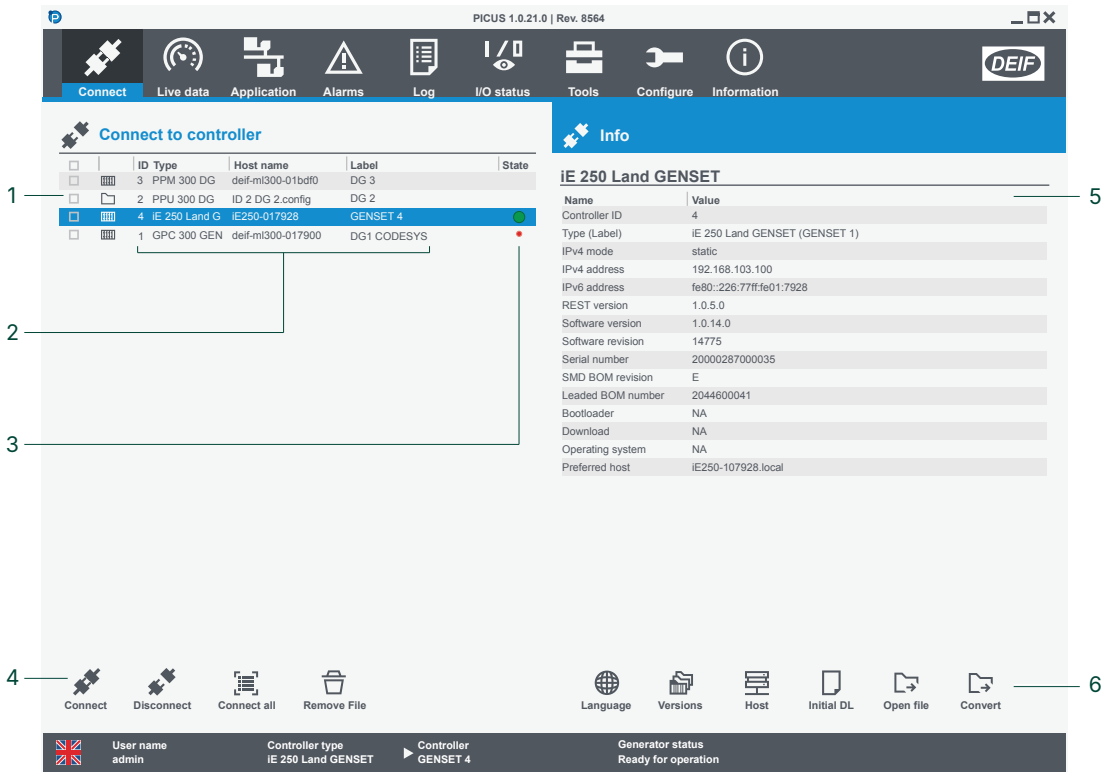

No.	Item	Notes
1	Controller list	List of available controllers or previously opened local files.
2	Controller information	Controller ID, Type, Host name, and Label
3	Connection state	Blank Controller available, not connected. Small green dot • Logged on. Large green dot • Logged on and connected. Red dot • Not available or in Service mode.
4	Connection options	Connect to selected controllers. Disconnect from selected controllers. Log on to All controllers. Remove file from list.
5	Controller information	Summary information for the selected controller in the list.
6	Actions	Change Language . View Versions information. Connect directly to a known Host . Start Initial DL of firmware to controllers. Open a backup or configuration, or folder. Convert a file: <ul style="list-style-type: none"> • Backup file to configuration file or folder. • Folder to configuration file.

3.1.1 Open offline project file

Offline projects can be stored as a:

- backup file (.backup):
 - Read only access, information cannot be saved.
- configuration file (.config)
- folder

To open an offline project:

1. Select **Open** .
2. Locate where the file or folder is stored.
3. Highlight the file or folder and select **Open**.
 - The backup, configuration, or folder is added to the **Connect page** as a folder in the controller list.



	ID Type	Host name	Label	State
<input type="checkbox"/>	9 PPM 300 DG	ID 9 DG 1.backup	DG 1	

4. Highlight the folder from the list and select **Connect** .



More information

See [Backup](#) for more information about how to create a backup (.backup) file.

3.1.2 Convert

Use this option to convert project files.

- Convert Backup (.backup) files created with PICUS 1.0.8.x or later to Configuration (.config) files or new folders.
- Convert Backup folders created with PICUS 1.0.10.x or later to Configuration (.config) files. Older backup folders cannot be converted.

Multiple backup files can be converted to a selected format.

To convert a file:

1. Select **Convert** .
2. Locate where the file is stored.
3. Highlight the file and press **Open**.
4. Select the **Save as** type and location.

The file is now converted and added to the controller list.

3.1.3 Connect host

To connect to a known or previously connected host:

1. Select **Host** .

 - A prompt is shown on screen:

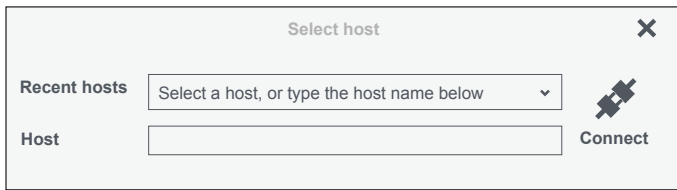

2. Enter the host name or IPv4 address, or you can select a previously connected host from the available list.
3. Select **Connect**  to connect to the host.
 - PICUS attempts to log on with the same user name and password.

3.1.4 Initial download (Initial DL)



Controllers supplied by DEIF are pre-installed with the necessary application software. **Initial DL** does not update on systems running in application mode.

NOTICE

Use for Initial download

The Initial DL option is ONLY to be used where the firmware update has NOT been applied correctly. In all other situations the [Firmware](#) page should be used to apply new software.

For Multi-line 300 (PPM, PPU, GPC, GPU)

If a firmware update has failed, the System status LED  on the PCM3.1 and the Internal communication status LED  on the PSM3.1 flash for more than one minute.

In this situation, use **Initial DL** to apply the software to the controller.

Apply an initial download to one controller at a time:

1. Select the required controller from the list.
2. Select **Initial DL** .
3. Select the required controller and the firmware package to apply.



More information

See [Firmware](#) for more information about how to apply a new software upgrade.

If you experience any problems with **Initial DL**, contact DEIF support.

3.2 Versions page

The versions page can be useful if you need to contact [DEIF support](#) for assistance.

The screenshot shows the DEIF software interface. At the top, there is a navigation bar with icons for Connect, Live data, Application, Alarms, Log, I/O status, Tools, Configure, and Information. The main content area is titled 'Versions' and displays a list of controllers and their associated modules (BSP, PSM3.1, ACM3.1, IOM3.1, EIM3.1, GAM3.1). A left sidebar shows 'Controllers' with a filter for 'Connected units' and 'HYBRID 1'. A bottom status bar shows user information and generator status.

No.	Item	Notes
1	Controller or filter	View by controllers or by filter: Controllers : Shows version information based on connected units. Filter : Shows version information based on filter selection.
2	List controls	Expand all : Expands all items in the list. Collapse all : Collapses all items in the list.
3	More options	Include or exclude extra information: <ul style="list-style-type: none"> • Revision • Modules • Path • Differences
4	Collapse item	Collapses the specific item box.
5	Version information	Shows the version information for the item.

3.2.1 Differences

You can highlight any differences between connected controllers. For example, the difference in controller software version.

Show differences

1. Connected and log on to the different controllers.
 - Example: GENSET 1 and GENSET 2.
2. Select **More options** and select **Show differences**.
3. Any differences are now shown highlighted:

The screenshot displays the PICUS 1.0.21.0 | Rev. 8654 interface. The top navigation bar includes icons for Connect, Live data, Application, Alarms, Log, I/O status, Tools, Configure, and Information. The 'Versions' section is active, showing a list of controllers on the left and detailed information on the right. The 'Controllers' list shows 'Connected units' with 'GENSET 1' and 'GENSET 2' selected. The 'Controller' table shows the following data:

Device label	REST	Application
GENSET 1	1.0.5.0 (NA)	1.0.16.0 (3301)
GENSET 2	1.0.5.0 (NA)	1.0.25.0 (15902)

The 'BSP' table shows the following data:

Device label	Bootloader	Download	Operating system
GENSET 1	3.0.1.0 (gd824b40)	3.0.1.0 (gd824b40)	3.0.1.0 (gd824b40)
GENSET 2	3.0.1.0 (gd824b40)	3.0.1.0 (gd824b40)	3.0.1.0 (gd824b40)

- GENSET 1 is running application 1.0.16.0 and GENSET 2 is running 1.0.25.0.

4. Live data

4.1 Live data page

The information shown depends on the type of product and controller connected.

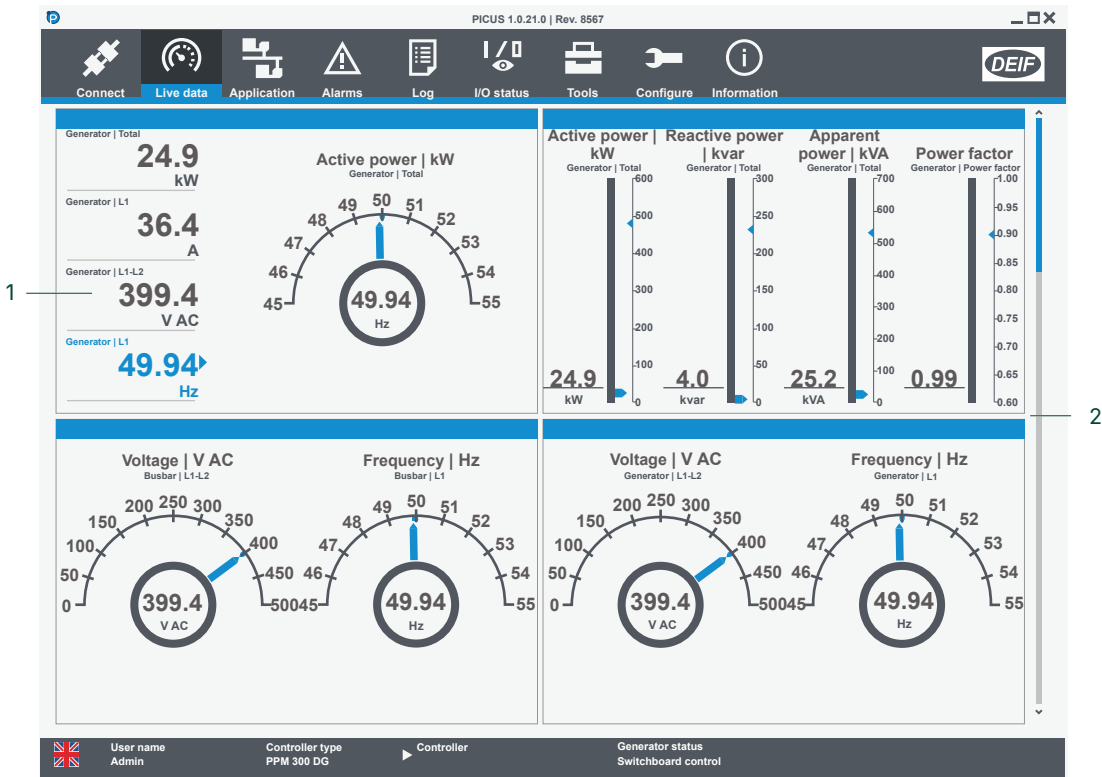



No.	Item	Notes
1.	Changeable display information	Some information displays can be changed.
2.	Scrollable list of live data information	Shows various operating information.

5. Application

5.1 About Application

Use Application to supervise or emulate the system, and also configure the Application drawing.

-  **Supervision** Allows you to supervise the asset or system.
See the operational state and I/O status, and use operator commands.

-  **Emulation *** Allows you to emulate the operation of the asset and system.
See the operational state and I/O status, and use operator commands.
You can also simulate events or I/O channels, and apply emulated loads.

-  **Configuration** Allows you to configure the Application diagram.
Drag and drop controllers and elements, and define how they are connected.

NOTE * Emulation must be enabled in Parameters to use this feature.



We would love to hear from you.







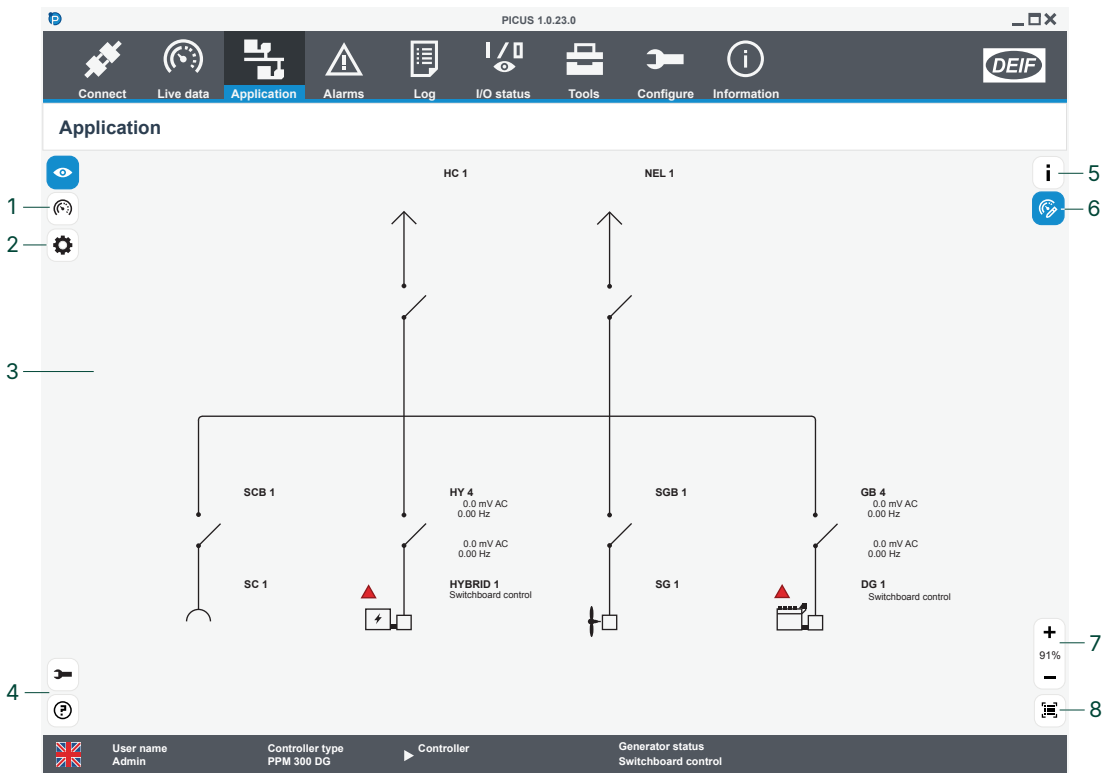

Help us improve our documentation by giving us feedback.

[Click here](#)



5.2 Supervision page

Select and zoom in on a controller to control it, or select and use the  **Controls** option at the right.

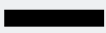
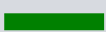

No.	Item	Notes
1	Emulation	Use  Emulation to emulate and test operation.
2	Configuration	Use  Configuration to add equipment to the diagram.
3	Single-line diagram	Shows the equipment, connections, and current operation state for the application.
4	Application settings	 Settings : Shows settings for this page.  User guide : Shows keyboard short-cuts.
5	Information	 Information : Shows the information about the selected element.
6	Controls	 Controls : For a selected controller, controls the equipment and views input/output status.
7	Zoom control	 Zoom in : Increases magnification.  Zoom out : Decreases magnification.
8	Fit to page	 Zoom to fit : Automatically zooms the diagram to fit the page.

5.2.1 Default theme colours

Line	Colour	Notes
	Black	Dead busbar (voltage < 10 % of nominal voltage).
	Green	Live busbar.
	Yellow	Unknown state.
	Orange	Voltage present but is not within acceptable range.



5.2.2 Change mode

You can change controller mode similar to the display buttons.

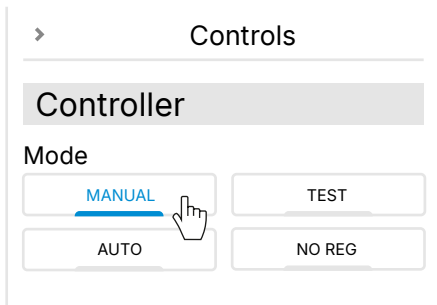
1. Select the controller on the application.
2. The **Controls**  opens automatically.
3. Change the controller mode as necessary:



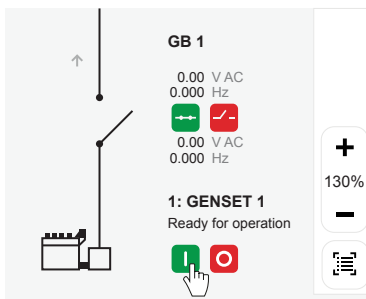

5.2.3 Start or stop equipment

1. Zoom in on the equipment to control.
2. Select  **Start** or  **Stop** as necessary:



5.2.4 Close or open the breaker

1. Use zoom controls to zoom in on the equipment to control.
2. Select  **Close breaker** or  **Open breaker** as necessary:

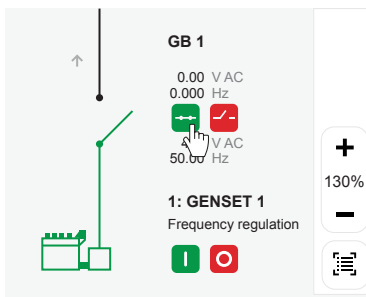

5.2.5 Input/output information

In Supervision you can view the input and output values.

1. Select the controller on the application.
2. The **Controls**  opens automatically.
3. Select **I/O**:



4. The *Card configuration* is shown.

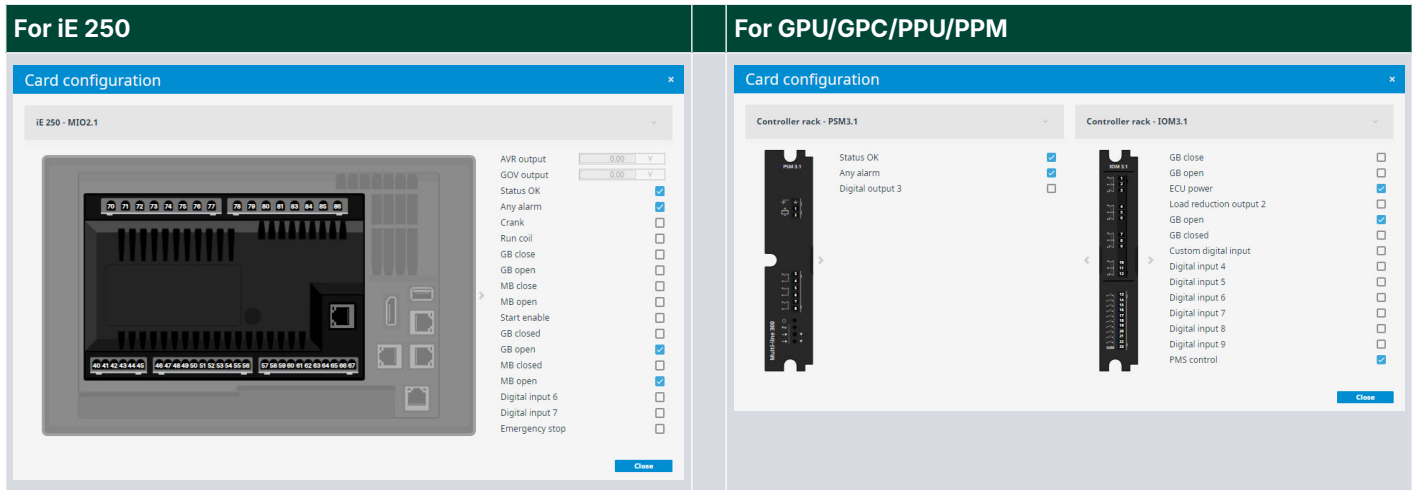

The state of the digital inputs or outputs are shown:

- : Not activate
- : Active

The state of the analogue inputs or outputs are shown with their value:

-

Use the navigation options,  left or  right to change the hardware module:



Select hardware







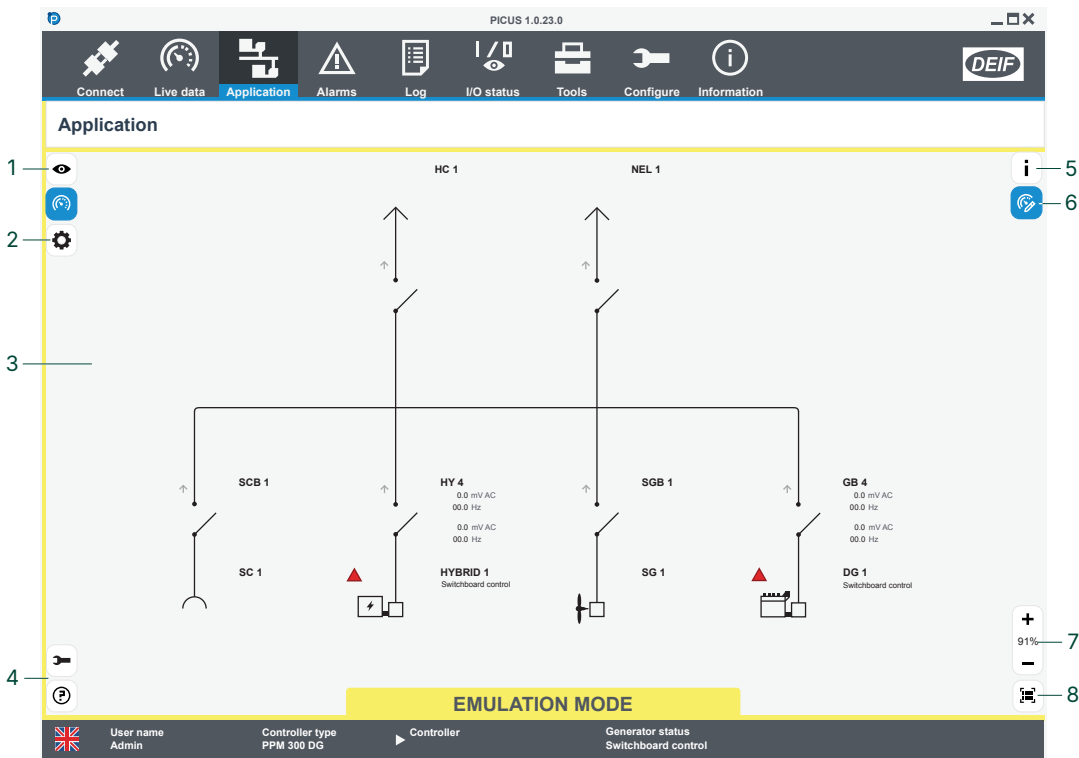

You can select the hardware or module by using  :







5.3 Emulation page

Select and zoom in on a controller to control it, or select and use the  **Controls** option at the right.



No.	Item	Notes
1	Supervision	Use  Supervision to change to the Supervision page.
2	Configuration	Use  Configuration to add equipment to the diagram.
3	Single-line diagram	Shows the equipment, connections, and current operation state for the application.
4	Application settings	 Settings : Shows settings for this page.  User guide : Shows keyboard short-cuts.
5	Information	 Information : Shows the information about the selected element.
6	Controls	 Controls : For a selected controller, controls the equipment and simulates input/output values.
7	Zoom control	 Zoom in : Increases magnification.  Zoom out : Decreases magnification.
8	Fit to page	 Zoom to fit : Automatically zooms the diagram to fit the page.

5.3.1 Default theme colours

Line	Colour	Notes
	Black	Dead busbar (voltage < 10 % of nominal voltage).
	Green	Live busbar.
	Yellow	Unknown state.
	Orange	Voltage present but is not within acceptable range.



5.3.2 Change mode

You can change controller mode similar to the display buttons.

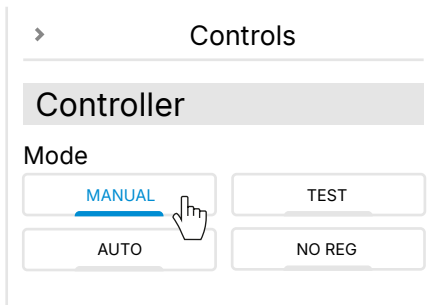
1. Select the controller on the application.
2. The **Controls**  opens automatically.
3. Change the controller mode as necessary:



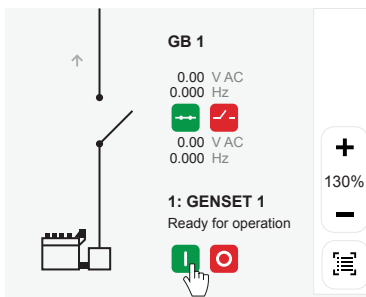

5.3.3 Start or stop equipment

1. Zoom in on the equipment to control.
2. Select  **Start** or  **Stop** as necessary:



5.3.4 Close or open the breaker

1. Use zoom controls to zoom in on the equipment to control.
2. Select  **Close breaker** or  **Open breaker** as necessary:

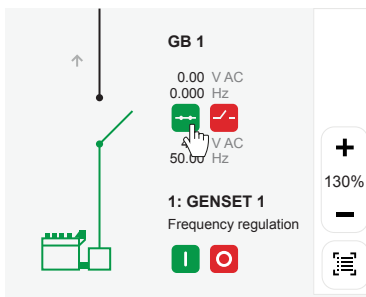

5.3.5 Input/output information

In Emulation you can both view and simulate the input and output values.

1. Select the controller on the application.
2. The **Controls**  opens automatically.
3. Select **I/O**:



4. The *Card configuration* is shown.

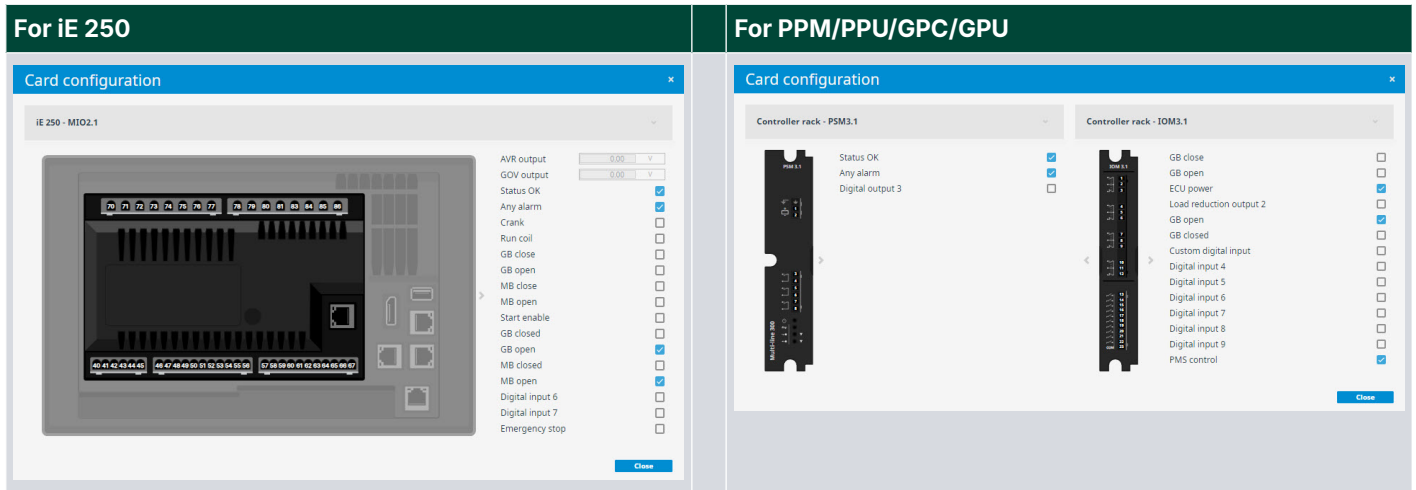

Change digital input or output state:

The state of the digital inputs or outputs can be simulated:

- : Not active
- : Active

Change analogue input or output state:

The state of the analogue inputs or outputs can be edited with a new value:

-

Use the navigation options,  left or  right to change the hardware module:



Select hardware

You can select the hardware or module by using  :

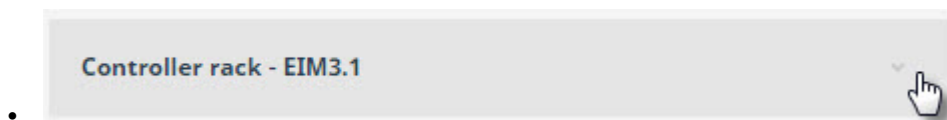

5.3.6 Simulate events

In Emulation you can simulate the occurrence of events, for example a Start failure.

1. Select the controller on the application.
2. The **Controls**  opens automatically.
3. Select **Emulator**:



4. You can simulate different events or values:

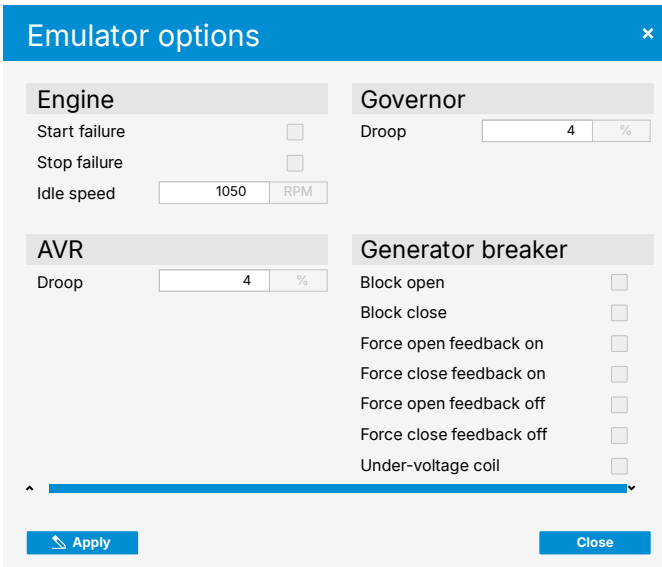

5.4 Configuration page

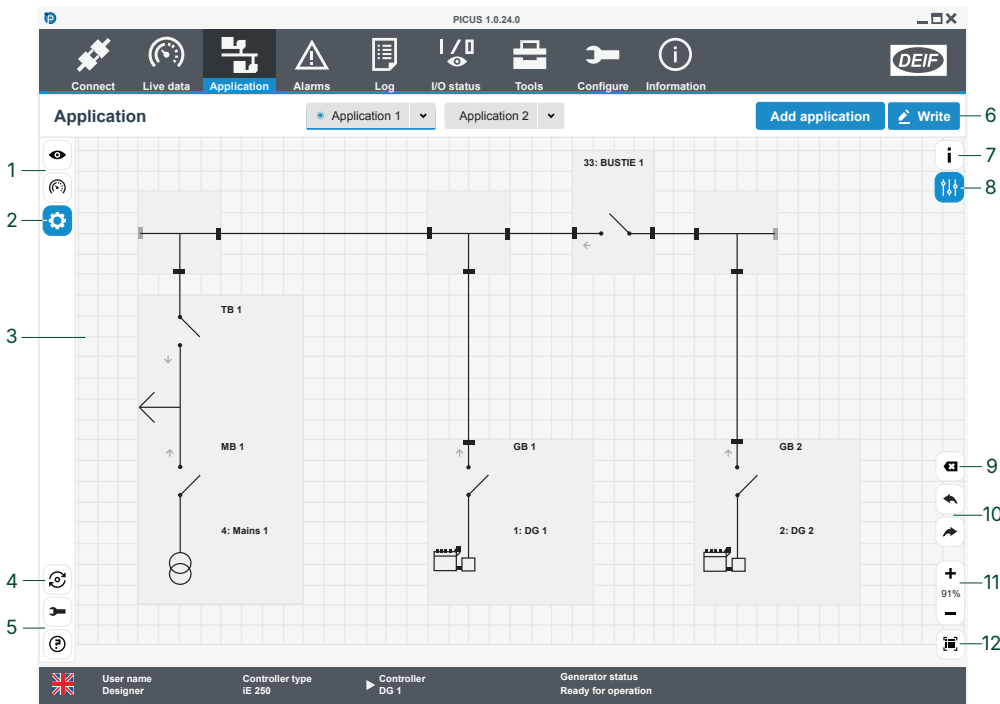

No.	Item	Notes
1	Supervision or Emulation	Supervision : Change to Supervision . Emulation : Change to Emulation .
2	Configuration	Use Configuration to add equipment .
3	Canvas	Shows the equipment and connections for the application.
4	Reload	Reloads the application from the controller.
5	Application settings	Settings : Shows settings for this page. User guide : Shows keyboard short-cuts.
6	Application	Add, remove or activate application. Write the application and broadcast to other controllers.
7	Information	Information : Shows the information about the selected element.
8	Element configuration	Configuration : Configures the selected element.
9	Clear plant	Clear plant : Clears the application diagram.
10	Undo and redo	Undo : Removes last action. Redo : Restores last action.
11	Zoom control	Zoom in : Increases magnification. Zoom out : Decreases magnification.
12	Zoom to fit	Zoom to fit : Automatically zooms the application to fit the page.

All controllers must have a controller ID assigned before you can configure an application diagram. An alarm occurs if the application does not match the connected equipment.

5.4.1 Add or remove equipment

Add equipment

1. Open  **Configuration**.
2. Select **Equipment**.

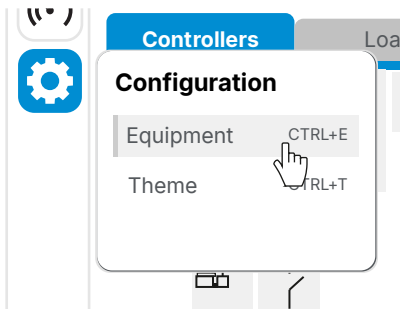

3. Select the type of equipment you want to add:

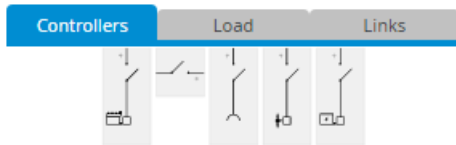

4. Select and drag the equipment on to the canvas:

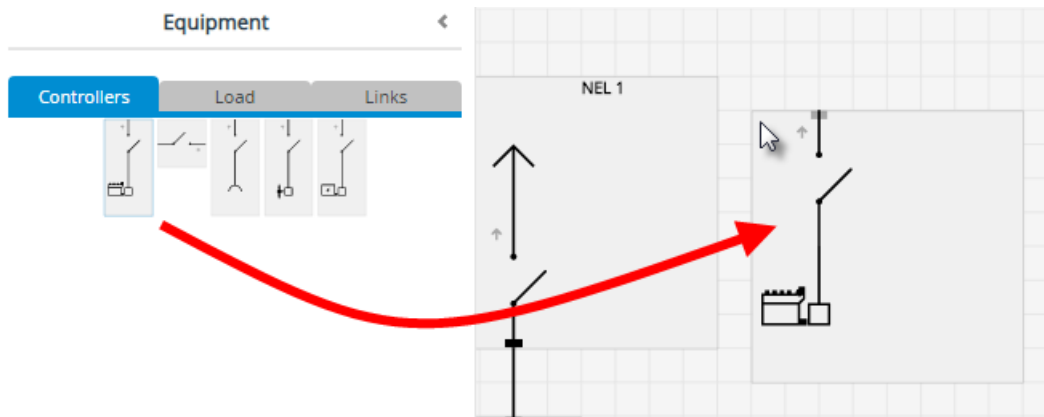

- You can add multiple equipment of the same type at the same time by double-clicking in different places on the canvas.

NOTE You can also use the short-cut **CTRL+E** to open the equipment selection.

Remove equipment

1. Select the equipment (or group) on the canvas.
 - Selection is shown as a blue box around the equipment or group.
2. Press delete.

5.4.2 Add or remove connections

Connect equipment

1. Select the grey connection point  on the equipment:

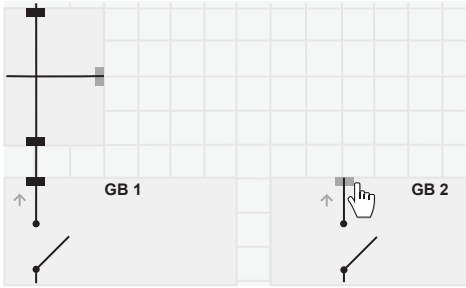

2. Drag to the connection point on the other equipment:

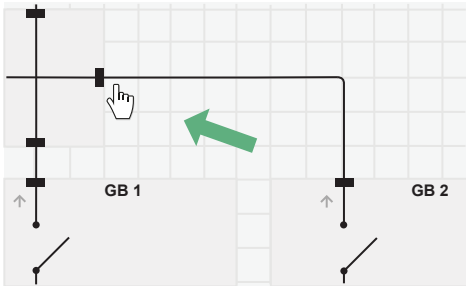

3. A connection is made between the equipment.

- The connection point changes from grey to black to indicate it is connected.

Remove a connection

1. Select connection:

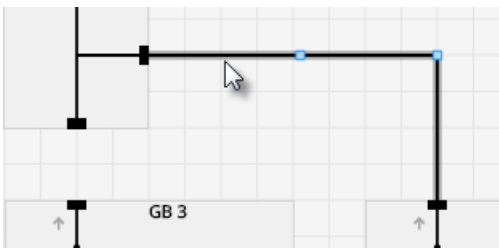

2. Press delete.

5.4.3 Configure equipment

1. Select the equipment on the canvas which opens the  **Equipment configuration**.
2. You can configure the settings for the equipment, including breaker and controller settings.
 - This includes the breaker feedback and breaker measurement settings.
3. You can rotate the equipment by selecting the direction option:



NOTE You can also use the short-cut **CTRL+C** to open the equipment configuration.

5.4.4 Group or ungroup equipment

Group equipment

1. Select all the equipment on the application that you want to group together by using left click + shift.
2. Use right click and select **Create group**.

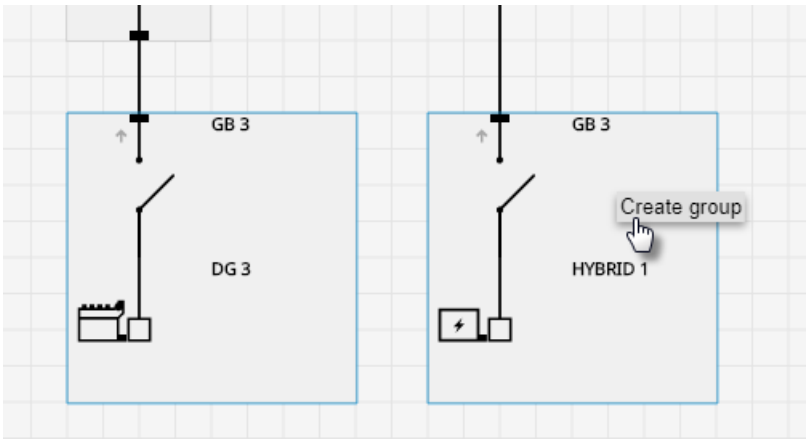

3. You can also give the group a name by double-clicking the group name:

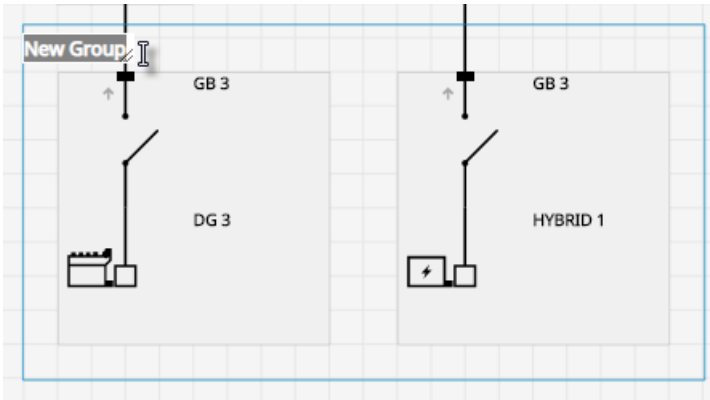

Ungroup equipment

1. Select the equipment group on the application that you want to ungroup.
2. Use right click and select **Ungroup**.

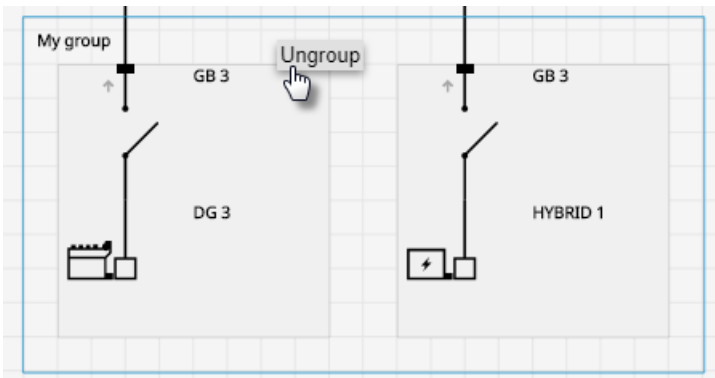

5.4.5 Add a ring busbar connection

1. Make sure to have two free connection points on the application, add links if required.
2. Select one of the grey connection points  and drag to the other end:

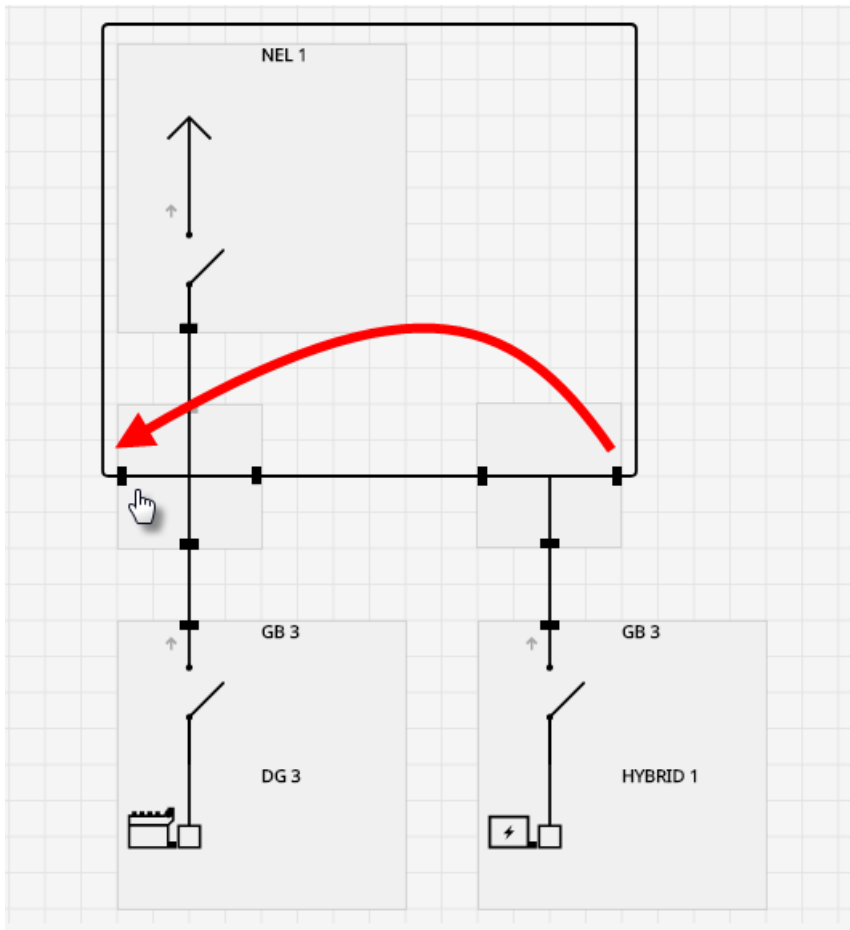

- The connection point changes from grey to black to indicate it is connected.

5.4.6 Configure breaker under-voltage coil

1. Open  **Configuration**.
2. Select the controller which controls the breaker.
3. Under **Breaker** you can select **Under-voltage coil**.

- The breaker shows the symbol:

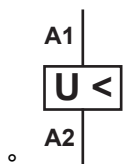

4. Use **Broadcast** to write settings to the controllers in the system.

5.4.7 Add QuickConnect (GPC 300)

QuickConnect allows you to add any unit (or group) to the system even if they are not part of the application.

Each unit (or group) must have one **QuickConnect** point in the application.

The application updates to show all connected units (or groups), allowing you to supervise the whole system.

1. Open  **Configuration**.
2. Select **QuickConnect**.

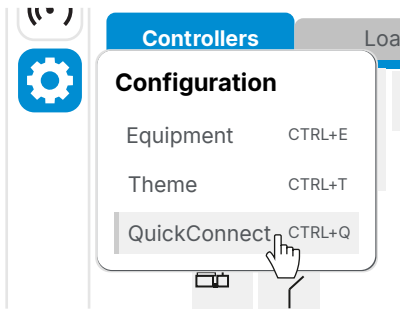

3. Select **Enable** to add **QuickConnect** to the application.
4. Enter a unique **ID**, **Label**, and initial the initial orientation either above or below.
 - You can also rotate this later as needed with the rotation tool.
5. Connect the **QuickConnect** to the required connection point(s) on the application.

NOTE The application must be the same in the different units (or groups).

Remove QuickConnect

1. Select **QuickConnect** on the application.
 - Selection is shown as a blue box around the equipment or group.
2. Press delete.

5.4.8 Broadcast application to controllers

You must broadcast any changes to the application to the controllers to take effect. Only controllers connected and logged on are shown.

1. Select .
2. Select the controller(s):

Select controller(s)

<input checked="" type="checkbox"/>	ID	Type	Host name	Label	Status
<input checked="" type="checkbox"/>	3	GENSET	192.168.18.250	GENSET 1	Ready
<input checked="" type="checkbox"/>	2	MAINS	192.168.18.240	MAINS 1	Ready

Select application to activate Application 1 ▾

Broadcast to CAN controllers

Cancel
Write

- If there is more than 1 application, you can select the application to activate.
- If there are CAN controllers you can also broadcast to these.
- Any controllers that are not ready, can be overridden with a confirmation.

 **CAUTION**



Manual override action

PICUS allows you to broadcast to controllers, even if they are not safe for commissioning. You must confirm this override action manually.

3. Select  to broadcast to the selected controllers.

5.4.9 Create or edit themes

You can configure the busbar colours shown on Supervision and Emulation. You can select between different themes or create a new theme with your own custom colours.

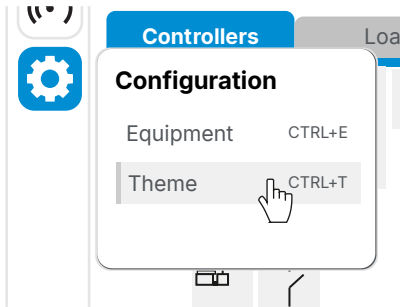

1. Open  **Configuration**.

2. Select **Theme**.

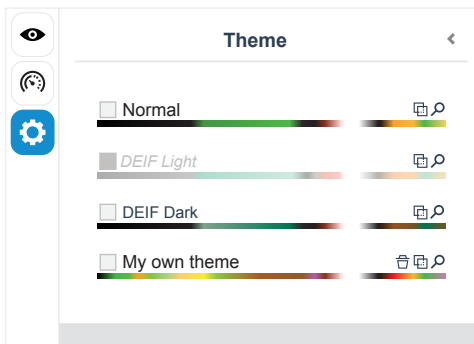

3. The themes available are shown:



-  View or edit the theme colours. *
-  Copy and create a new theme.
-  Deletes a custom theme.

4. Select a theme to make it the activate theme.

NOTE * You cannot edit the default DEIF themes.

6. Alarms

6.1 About the alarms

The controller alarms prevent unwanted, damaging, or dangerous situations from occurring. The Operator must review all activated alarms for cause and suitable action.

Each alarm has an *Alarm condition* which determines if the alarm is activated. When the *Alarm condition* is detected (typically, the operating value reaches the *Set point*), the controller starts the *Time delay* (t_{delay}).

During the *Time delay* the controller checks whether the *Alarm condition* remains active:

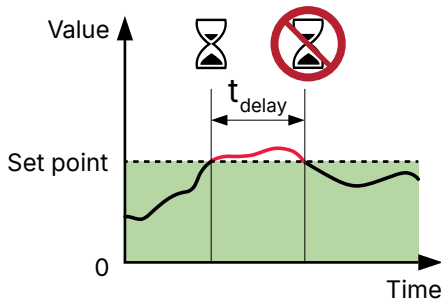

If the *Alarm condition* is no longer active, the *Time delay* is reset and the alarm is not activated.

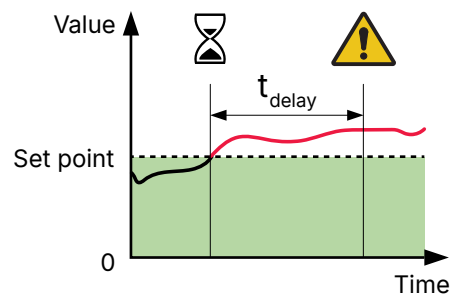

If the *Alarm condition* continues and the *Time delay* expires, then the *Alarm action* is activated.

Some alarms do not have a *Time delay* (t_{delay}) and these activate immediately.

The alarm results in both a visual, and an optional acoustic (or audible) indication. Some alarms can be configured to be automatically acknowledged. *Auto acknowledge* can be useful during commissioning and troubleshooting.

During operation the system continues to monitor for *Alarm condition(s)* and moves alarms between different [Alarm states](#) as necessary. Operators can also move the alarm(s) to other states:

Alarms that are activated in a system must be reviewed for cause and action to resolve them.

Activated alarms require Acknowledgement and then action to resolve the *Alarm condition*. For most alarms, once the *Alarm condition* has been resolved, the *Alarm action* is no longer active. Some alarms may be configured with an additional step before the *Alarm action* can be removed. This step requires the operator to clear the *Alarm latch* before the *Alarm action* becomes inactive.

Operators can also move the alarm(s) to other states:





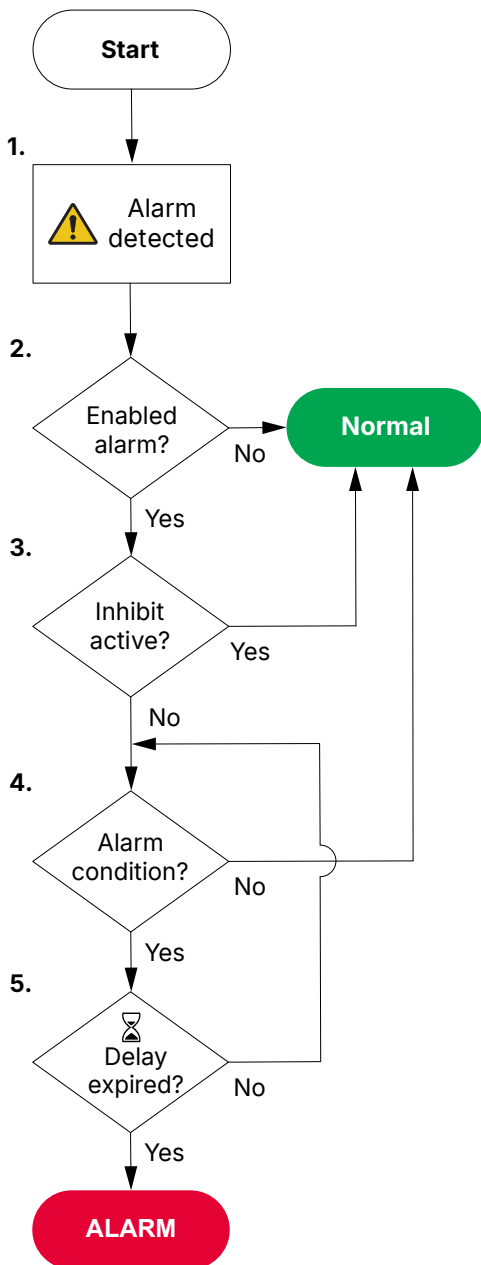











- Out of service
- Shelved

6.1.1 Alarm flowchart



1. The controller detects an *Alarm condition*.
2. The controller checks if the alarm is enabled:
 - If the alarm is not enabled the controller ignores the alarm.
3. The controller checks if the alarm has an active inhibit.
 - If the alarm has an active inhibit the controller ignores the alarm.
4. The controller checks if the *Alarm condition* is still active:
 - If the *Alarm condition* is no longer active the controller ignores the alarm.
5. While the *Alarm condition* is active, the controller checks if the *Time delay* has expired:
 - If the *Alarm condition* is no longer active before the *Time delay* expires, the controller ignores the alarm.
 - If the *Alarm condition* continues and the *Time delay* expires, the controller activates the alarm and the *Alarm action*.

6.1.2 Alarm states

Symbol	Alarm condition *	Alarm action **	Acknowledge	Notes
 or 	Active	Active	Unacknowledged	<ul style="list-style-type: none"> An alarm condition occurred. An alarm action is active. An alarm requires acknowledgement. An alarm requires action to clear the alarm condition.
 or 	Active	Active	Acknowledged	<ul style="list-style-type: none"> An alarm condition occurred. An alarm action is active. An alarm is acknowledged. An alarm requires action to clear the alarm condition.
 or 	Inactive	Active	Unacknowledged	<ul style="list-style-type: none"> An alarm condition has cleared. An alarm action is active. An alarm requires acknowledgement. An alarm latch requires reset.
 or 	Inactive	Active	Acknowledged	<ul style="list-style-type: none"> An alarm condition has cleared. An alarm action is active. An alarm is acknowledged. An alarm latch requires reset.
 or 	Inactive	Inactive	Unacknowledged	<ul style="list-style-type: none"> An alarm condition occurred, but was cleared. An alarm action is inactive. An alarm requires acknowledgement.
 or 	Active or Inactive	Inactive	-	<ul style="list-style-type: none"> An alarm is shelved for a period of time. An alarm returns automatically after the period has expired.
 or 	Active or Inactive	Inactive	-	<ul style="list-style-type: none"> An alarm is marked <i>out of service</i> for an indefinite period. An alarm does not return automatically and must be returned to service manually.
 or 	Active or inactive	Inactive	-	An alarm is inhibited to occur.

NOTE * *Alarm condition* is usually where the *Set point* is exceeded.

** *Alarm action* (the protection) is the configured action taken to protect the situation. When active, the controller activates the action.

6.2 Alarms page

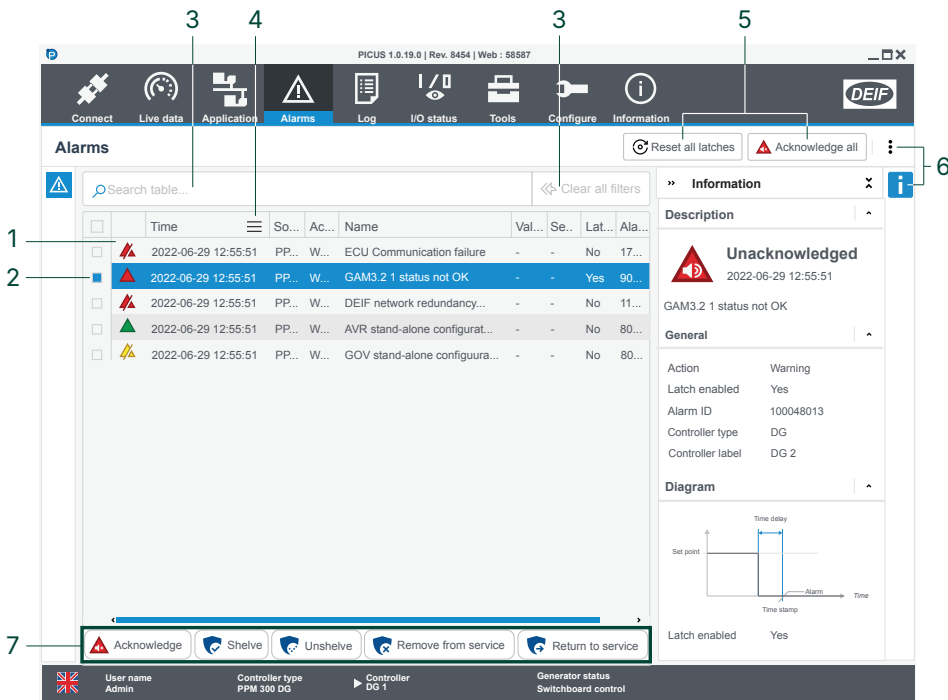

No.	Item	Notes	
1	List of alarms	Unacknowledged alarm.	Acknowledged alarm.
		Unacknowledged latched alarm.	Acknowledged latched alarm.
		Unacknowledged cleared alarm.	Acknowledged cleared alarm.
		Shelved alarm.	Out of service alarm.
		Inhibited alarm.	
2	Alarm selection	<input type="checkbox"/> Not selected. <input checked="" type="checkbox"/> Selected.	
3	Search text	Enter a search term to filter the list. Clear all filters.	
4	Sort or filter	Use to sort or filter column values.	
5	Global actions	Reset all latches. Acknowledge all alarms.	
6	More options	Shows more actions. Shows more information about the alarm.	
7	Alarm actions	Acknowledge an unacknowledged alarm.	
		Shelve the alarm for the selected period. Unshelve a previously shelved alarm.	
		Remove from service the alarm. Return to service the alarm.	

6.2.1 Alarm handling and actions

When alarms are activated in the system, they appear on the [Alarms page](#) and the [Notification centre](#). The [Notification centre](#) provides quick access for some alarm handling. For more comprehensive alarm actions use the [Alarms page](#).

When alarms are activated in the system, they appear on the [Alarms page](#).

Sort of filter for alarms

You can sort or filter the list of alarms by using the  Filter.

Alarm information

Further information about each alarm can be displayed by using  Info.

This includes further details on the alarm, the controller, and on some alarms how the alarm was triggered.

Alarm information

Further information about each alarm can be displayed by using  Information.

This includes further details on the alarm, the controller, and on some alarms how the alarm was triggered.

Acknowledge

You must acknowledge alarms that are activated in the system.

Select the alarm (or alarms) to acknowledge and use **Acknowledge**.

Reset latches

Latched alarms can only be reset if the alarm is both acknowledged and the *Alarm condition* has cleared.

Select the alarm or alarms to reset the latch, and use **More > Reset all latches**.

Select the alarm or alarms to reset the latch, and use **Reset all latches**.

NOTICE



Shelve or Out of service alarms

Shelved or Out of service alarms are not recommended for normal operation and could cause dangerous situations.

Only use Shelve or Out of service during commissioning or troubleshooting situations.

Shelve

Some types of alarm can be shelved, that is, they can be temporarily suspended. When an alarm is shelved, a period of time must be given for how long the alarm remains in the shelve state. While shelved the *Alarm action* is not active. When the period of time has expired, the system automatically rechecks the *Alarm condition*, and if it is still active, the alarm triggers.

Shelving alarms is only recommended during commissioning or troubleshooting, and not during normal operation.

Select the alarm or alarms to shelve, and use **More > Shelve**. Enter the period of time for the shelve and confirm.

Select the alarm or alarms to shelve, and use **Shelve**. Enter the period of time for the shelve and confirm.

You can also manually unshelve a shelved alarm, by using **More > Unshelve**.

You can also manually unshelve a shelved alarm, by using **Unshelve**.

Remove from service

Some types of alarm can be removed from service, that is, they can be suspended. When an alarm is out of service, the *Alarm action* is not active. The Operator must return the alarm back to service. It does not automatically reinstate.

Select the alarm or alarms to mark as *Out of service*, and use **More > Remove from service**.

Select the alarm or alarms to mark as *Out of service*, and use **Remove from service**.

Return to service

Out of service alarms do not automatically reinstate. The Operator must return the alarm back to service.

Select the alarm or alarms to return to service, and use **More > Return to service**.

Select the alarm or alarms to return to service, and use **Return to service**.

6.2.2 Latched alarms

Alarms that have a latch enabled remain active even after they are acknowledged. This adds an additional layer of protection to the system.

How to reset latched alarms:

1. Acknowledge the alarm.
2. Clear the alarm condition.
3. Select  **Reset all latches**.

All acknowledged and latched alarms are now reset, and the actions (protections) become inactive.

6.2.3 Alarm tests



CAUTION



Alarm tests activate alarm actions (protections)

Activating an alarm test also activates the alarm actions. Only test alarms if it is safe.

To start an alarm test:

1. Select  **More options** at the top of the page.
2. Select either:
 - **Test enabled alarms**
 - **Test all alarms**
3. A confirmation message opens.
4. If it is safe to start the alarm test, select **Start test**.

The alarms remain active for as long as the alarm test is running. Stop the alarm test and acknowledge the alarms, to change the state of the alarms to inactive.

To stop an alarm test:

1. Select  **More options** at the top of the page.

2. Select **Stop test**.
3. Select **Stop test** to stop all active alarm tests.
 - It can take a moment for PICUS to stop the alarm test.

6.2.4 Shelved alarms

Only certain types of alarms can be shelved. Shelved alarms are not active, and become automatically unshelved after the shelf period expires. You can also unshelve alarms manually.

Shelve alarms

1. Mark the alarm or alarms to shelve.

<input type="checkbox"/>		Time	So...	Ac...	Name	Val...	Se..	Lat...	Ala...
<input type="checkbox"/>		2022-06-29 12:55:51	PP...	W...	ECU Communication failure	-	-	No	17...
<input checked="" type="checkbox"/>		2022-06-29 12:55:51	PP...	W...	GAM3.2 1 status not OK	-	-	Yes	90...
<input checked="" type="checkbox"/>		2022-06-29 12:55:51	PP...	W...	DEIF network redundancy...	-	-	No	11...
<input type="checkbox"/>		2022-06-29 12:55:51	PP...	W...	AVR stand-alone configurat...	-	-	No	80...
<input type="checkbox"/>		2022-06-29 12:55:51	PP...	W...	GOV stand-alone configura...	-	-	No	80...

2. Select **Shelve**.
3. You must select the shelf period:

Shelve until ×

Current date **2022-06-30**

Current time **14:30:36**

Date

Time

4. Enter the required shelf period.
5. Select **Set** to shelve the alarm or alarms.

- The alarm is marked as shelved in the alarm list.
- The alarm action (protection) is inactive until the alarm is unshelved.

<input type="checkbox"/>		Time	So...	Ac...	Name	Val...	Se..	Lat...	Ala...
<input type="checkbox"/>		2022-06-29 12:55:51	PP...	W...	ECU Communication failure	-	-	No	17...
<input checked="" type="checkbox"/>		2022-06-29 12:55:51	PP...	W...	GAM3.2 1 status not OK	-	-	Yes	90...
<input checked="" type="checkbox"/>		2022-06-29 12:55:51	PP...	W...	DEIF network redundancy...	-	-	No	11...
<input type="checkbox"/>		2022-06-29 12:55:51	PP...	W...	AVR stand-alone configurat...	-	-	No	80...
<input type="checkbox"/>		2022-06-29 12:55:51	PP...	W...	GOV stand-alone configura...	-	-	No	80...

Unshelve an alarm

1. Mark the alarm or alarms to unshelve.

<input type="checkbox"/>		Time	≡	So...	Ac...	Name	Val...	Se..	Lat...	Ala...
<input type="checkbox"/>		2022-06-29 12:55:51		PP...	W...	ECU Communication failure	-	-	No	17...
<input checked="" type="checkbox"/>		2022-06-29 12:55:51		PP...	W...	GAM3.2 1 status not OK	-	-	Yes	90...
<input checked="" type="checkbox"/>		2022-06-29 12:55:51		PP...	W...	DEIF network redundancy...	-	-	No	11...
<input type="checkbox"/>		2022-06-29 12:55:51		PP...	W...	AVR stand-alone configurat...	-	-	No	80...
<input type="checkbox"/>		2022-06-29 12:55:51		PP...	W...	GOV stand-alone configura...	-	-	No	80...

2. Select **Unshelve** to unshelve the alarm or alarms.

- The alarms are rechecked by the system.
- If the alarm condition is still present in the system, the alarm is activated again.

<input type="checkbox"/>		Time	≡	So...	Ac...	Name	Val...	Se..	Lat...	Ala...
<input type="checkbox"/>		2022-06-29 12:55:51		PP...	W...	ECU Communication failure	-	-	No	17...
<input type="checkbox"/>		2022-06-29 12:55:51		PP...	W...	GAM3.2 1 status not OK	-	-	Yes	90...
<input type="checkbox"/>		2022-06-29 12:55:51		PP...	W...	DEIF network redundancy...	-	-	No	11...
<input type="checkbox"/>		2022-06-29 12:55:51		PP...	W...	AVR stand-alone configurat...	-	-	No	80...
<input type="checkbox"/>		2022-06-29 12:55:51		PP...	W...	GOV stand-alone configura...	-	-	No	80...

6.2.5 Remove from service

When alarms are removed from service, they are no longer active.



Inactive alarm action (protection)

The alarm action (protection) becomes inactive while the alarm is out of service.

Remove alarms from service

1. Mark the alarm or alarms to remove from service.

<input type="checkbox"/>		Time	≡	So...	Ac...	Name	Val...	Se..	Lat...	Ala...
<input type="checkbox"/>		2022-06-29 12:55:51		PP...	W...	ECU Communication failure	-	-	No	17...
<input checked="" type="checkbox"/>		2022-06-29 12:55:51		PP...	W...	GAM3.2 1 status not OK	-	-	Yes	90...
<input checked="" type="checkbox"/>		2022-06-29 12:55:51		PP...	W...	DEIF network redundancy...	-	-	No	11...
<input type="checkbox"/>		2022-06-29 12:55:51		PP...	W...	AVR stand-alone configurat...	-	-	No	80...
<input type="checkbox"/>		2022-06-29 12:55:51		PP...	W...	GOV stand-alone configuura...	-	-	No	80...

2. Select **Remove from service**.

- The alarm is marked as out of service in the alarm list.

<input type="checkbox"/>		Time	≡	So...	Ac...	Name	Val...	Se..	Lat...	Ala...
<input type="checkbox"/>		2022-06-29 12:55:51		PP...	W...	ECU Communication failure	-	-	No	17...
<input checked="" type="checkbox"/>		2022-06-29 12:55:51		PP...	W...	GAM3.2 1 status not OK	-	-	Yes	90...
<input checked="" type="checkbox"/>		2022-06-29 12:55:51		PP...	W...	DEIF network redundancy...	-	-	No	11...
<input type="checkbox"/>		2022-06-29 12:55:51		PP...	W...	AVR stand-alone configurat...	-	-	No	80...
<input type="checkbox"/>		2022-06-29 12:55:51		PP...	W...	GOV stand-alone configuura...	-	-	No	80...

Return alarms to service

1. Mark the alarm or alarms to return to service.

<input type="checkbox"/>		Time	≡	So...	Ac...	Name	Val...	Se..	Lat...	Ala...
<input type="checkbox"/>		2022-06-29 12:55:51		PP...	W...	ECU Communication failure	-	-	No	17...
<input checked="" type="checkbox"/>		2022-06-29 12:55:51		PP...	W...	GAM3.2 1 status not OK	-	-	Yes	90...
<input checked="" type="checkbox"/>		2022-06-29 12:55:51		PP...	W...	DEIF network redundancy...	-	-	No	11...
<input type="checkbox"/>		2022-06-29 12:55:51		PP...	W...	AVR stand-alone configurat...	-	-	No	80...
<input type="checkbox"/>		2022-06-29 12:55:51		PP...	W...	GOV stand-alone configuura...	-	-	No	80...

2. Select **Return to service**.

- The alarms are rechecked by the system.
- If the alarm condition is still present in the system, the alarms activate again.

<input type="checkbox"/>		Time	≡	So...	Ac...	Name	Val...	Se..	Lat...	Ala...
<input type="checkbox"/>		2022-06-29 12:55:51		PP...	W...	ECU Communication failure	-	-	No	17...
<input checked="" type="checkbox"/>		2022-06-29 12:55:51		PP...	W...	GAM3.2 1 status not OK	-	-	Yes	90...
<input type="checkbox"/>		2022-06-29 12:55:51		PP...	W...	DEIF network redundancy...	-	-	No	11...
<input type="checkbox"/>		2022-06-29 12:55:51		PP...	W...	AVR stand-alone configurat...	-	-	No	80...
<input type="checkbox"/>		2022-06-29 12:55:51		PP...	W...	GOV stand-alone configuura...	-	-	No	80...

7. Log

7.1 Log page

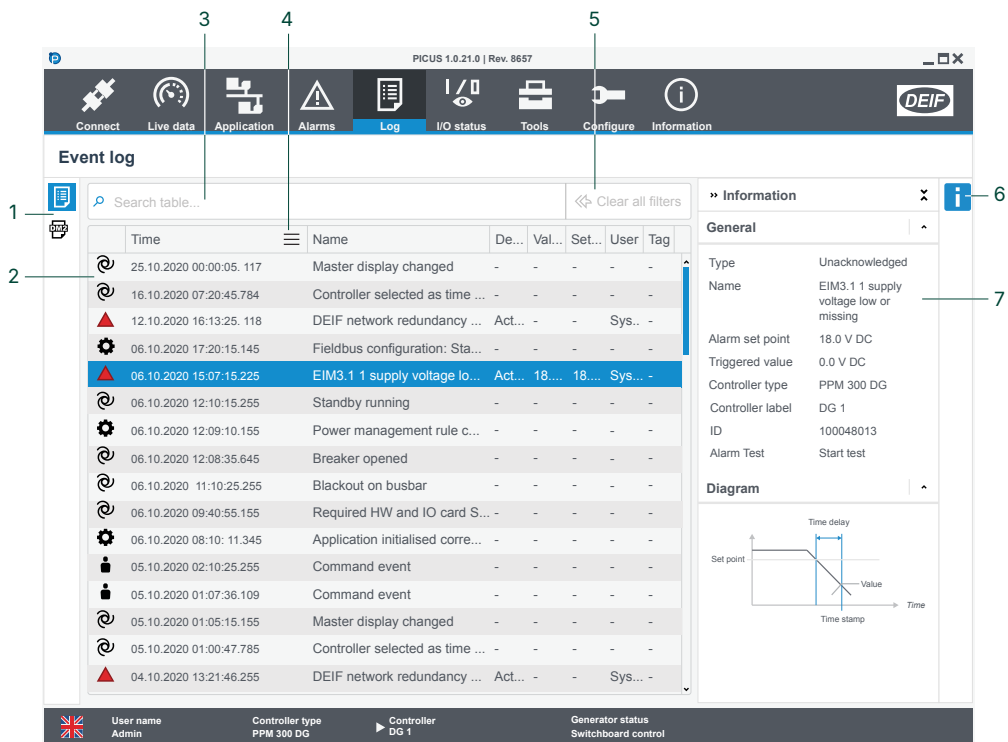

No.	Item	Notes
1	Change view	View Logs View DM2 logs.
2	Log of events	AUTO event. Manual event.
		System event. Button action.
		Parameter changes. Test.
		Unacknowledged alarm. Acknowledged alarm.
		Unacknowledged latched alarm. Acknowledged latched alarm.
		Unacknowledged cleared alarm. Acknowledged cleared alarm.
		Shelved alarm. Out of service alarm.
	Inhibited alarm.	
3	Search text	Enter a search term to filter the list.
4	Sort or filter	Use to sort or filter column values.
5	Clear search/filters	Clear all filters.
6	View information	Shows more information about the event.
7	Event information	Shows more information about the event.

7.2 DM2 Log page

No.	Item	Notes
1	Change view	View Logs View DM2 logs.
2	Log of DM2 events	Shows the list of DM2 log events.
3	Search text	Enter a search term to filter the list.
4	Sort or filter	Use to sort or filter column values.
5	Clear search/filters	Clear all filters.
6	Refresh log	Refresh log : Reloads the log list.
7	Clear DM2	Clear DM2 log : Removes all log entries only if the ECU supports this feature.

8. I/O status

8.1 I/O status page

No.	Item	Notes
1	Hardware selection	Select the hardware to include in the input / output status. <ul style="list-style-type: none"> • Controller • Extension rack • ECU • DAVR
2	Physical values	Include or exclude showing physical values for the inputs or outputs.
3	Analogue values	See the analogue inputs or analogue outputs values.
4	Reset sorting	Returns to the default sorting view for all lists.
5	Digital values	See digital inputs or digital outputs values.
		True : input or output is active. False : input or output is not active.

9. Tools

9.1 Settings

9.1.1 Settings page

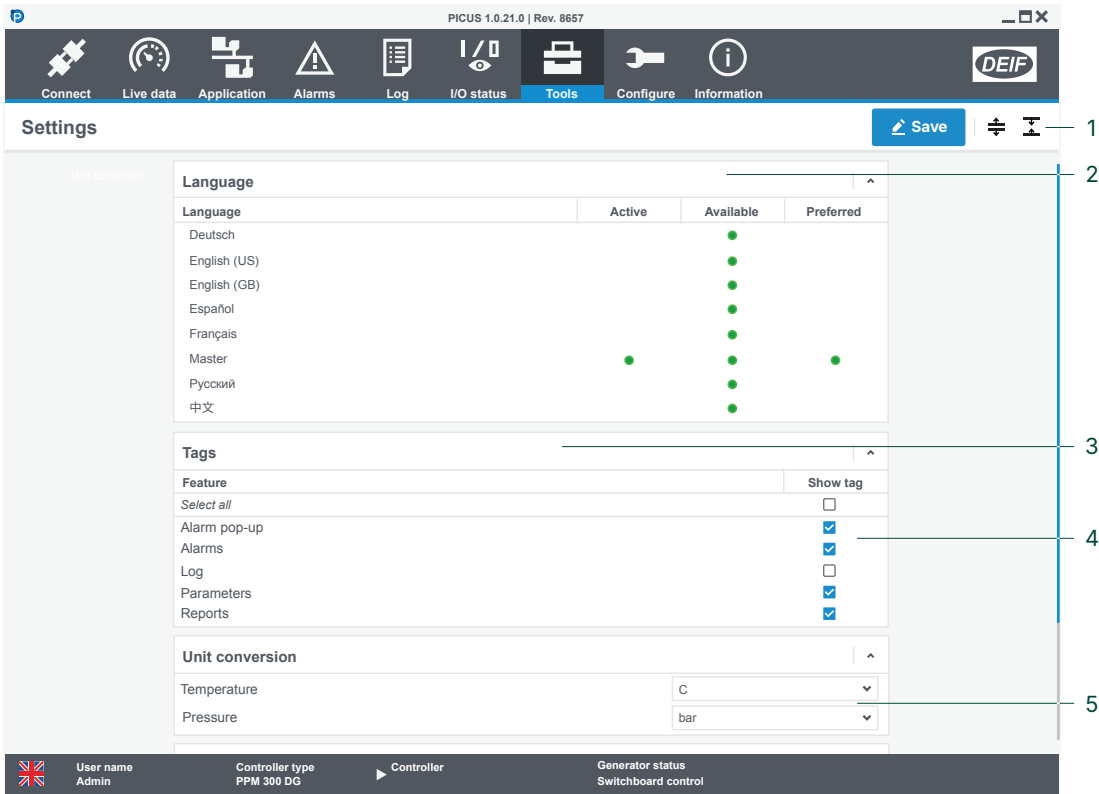

No.	Item	Notes
1	Controls	Save settings. Expand all settings. Collapse all settings.
2	PICUS language settings	Shows available languages for controller texts shown in PICUS.
	Active	Shows the active language for the controller texts in PICUS.
	Available	Shows the available languages.
	Preferred *	Shows the preferred language for controller texts in PICUS.
3	Tags settings	Shows where tags can be visible or hidden.
4	Show or hide tags	<input type="checkbox"/> Hide tag. <input checked="" type="checkbox"/> Show tag.
5	Unit conversion settings	Unit of measure for temperature or pressure.

NOTE * If you are not logged on to a controller, you can only see the language PICUS prefers to read from controllers. If the text for the preferred language is not available, the text is displayed in the **Master** language.

The **Master** language for the controller is **UK English**. It is not possible to view or configure custom texts when the **Master** language is active.

9.2 Permissions (iE 250/iE 350)

9.2.1 About permissions

Access to the controller's configuration and functionality is protected with user permissions. You can use PICUS to manage these permissions for your system.



More information

See **Permissions** in the **Designer's handbook** for how permissions work on the controller.

Always remember to use **Write** the update the controller.

9.2.2 Role management

No.	Item	Notes
1	Search	Search the list of roles.
2	Roles	List of roles and number of associated users.
3	Create new role	Creates a new role.
4	Actions	⌵ Expand all : Expands all items in the list. ⌶ Collapse all : Collapses all items in the list.
	⋮ More options	Only in Edit mode: <ul style="list-style-type: none"> • Duplicate role • Delete role
5	Edit	Edits the selected role.
6	Role information	Shows the selected role name and information.
7	Role permissions	Shows the feature permissions for the selected role.

9.2.3 Users page

The screenshot displays the 'User management' interface. On the left, a 'Filter' table lists users and their associated roles. The main area shows the 'User information' form for the selected user 'admin'. The form includes fields for 'User name', 'Organisation', 'Contact details' (Mobile no., Direct no., Email), and 'User role' (admin, provisioner). A 'Create new user' button is located at the bottom left, and an 'Edit' button is at the top right. Numbered callouts 1-8 indicate specific UI elements: 1 (Search), 2 (Users list), 3 (Create new user), 4 (Edit button), 5 (More settings), 6 (User information), 7 (Role permissions), and 8 (Change password).

No.	Item	Notes
1	Search	Search the list of roles.
2	Users	List of users and number of associated roles.
3	Create new user	Create or duplicate a new user.
4	Actions	⌵ Expand all : Expands all items in the list. ⌵ Collapse all : Collapses all items in the list.
4	⋮ More : Additional settings.	Only in Edit mode: <ul style="list-style-type: none"> • Duplicate user • Delete user
5	Edit	Edits the selected user.
6	User information	Shows the selected user.
7	Role permissions	Shows the permissions for the selected user.
8	Password	Change password for selected user.

9.3 Permissions (GPU/GPC/PPU/PPM)

9.3.1 About permissions

Access to the controller's configuration and functionality is protected with user permissions. You can use PICUS to manage these permissions for your system.



More information

See **Permissions** in the **Designer's handbook** for how permissions work on the controller.





Always remember to use **Write** to update the controller.

9.3.2 Groups page

No.	Item	Notes								
1	Group list and selection	Shows a list of permission groups and number of users assigned to that group. <ul style="list-style-type: none"> Green dot shows the group for the currently logged on user. 								
2	Group permissions	Permissions access for the different areas of the controller software and/or PICUS features.								
3	Group information	Details about the selected group.								
4	Options	<table border="0"> <tr> <td> Create a new group.</td> <td> Copy a group to a new group.</td> </tr> <tr> <td> Edit the selected group.</td> <td> Delete the selected group.</td> </tr> <tr> <td> Save the changes locally.</td> <td> Cancel the edit of a group.</td> </tr> <tr> <td> Refresh the permissions.</td> <td> Write the permissions to the controller.</td> </tr> </table>	Create a new group.	Copy a group to a new group.	Edit the selected group.	Delete the selected group.	Save the changes locally.	Cancel the edit of a group.	Refresh the permissions.	Write the permissions to the controller.
Create a new group.	Copy a group to a new group.									
Edit the selected group.	Delete the selected group.									
Save the changes locally.	Cancel the edit of a group.									
Refresh the permissions.	Write the permissions to the controller.									



9.3.3 Manage groups

Create a group

1. Select  **Create** for a new group, or use  **Copy** to duplicate a group.
2. Enter the Name and optional Owner and Notes for the group.
3. Select  **Save** to save the new group settings locally.
4. Select  **Write** to write the permissions to the controller.

The new group is created with read access permissions by default.

Edit a group

1. Select the group.
2. Select  **Edit**.
3. Edit the Name and optional Owner and Notes for the group.
4. To change the group permissions, select the permission from the list (details are shown on the right).
5. Select the Access permission.
6. Select  **Save** to save the new group settings locally.
7. Select  **Write** to write the permissions to the controller.

Delete a group

If you delete a group you also delete all the assigned users of that group. The groups Administrators and Display cannot be deleted.

1. Select the group to delete from the list.
2. Select  **Delete**. You are prompted to confirm the deletion.
 - Any users assigned to the group are listed.
3. Select **Yes** to delete the group with any assigned users.

9.3.4 Users page

Users

User	Group	Created	Last logon
Operator 1	Operators	21-05-2014 07:15:20	12-02-2020 09:37:45
Operator 2	Operators	21-05-2014 07:24:11	11-12-2018 11:45:18
Service	Service engineers	21-05-2014 07:27:16	07-01-2019 07:15:20
Service 2	Service engineers	19-09-2018 12:34:08	12-10-2020 12:40:21
Designer	Designers	21-05-2014 07:08:10	11-02-2018 19:46:30
Admin	Administrators	21-05-2014 07:03:17	13-10-2020 16:25:19
Admin BK	Administrators	21-05-2014 07:04:36	12-10-2020 09:57:51

User settings

Operators

Name: Operator 1
 Organisation: DEIF A/S
 Group: Operators

Contact information

Mobile no.: +45 9614 9614
 Direct no.: +45 9614 9614
 Email (primary): support@deif.com
 Email (secondary):

Notes





Create Copy Edit Delete Save Cancel Read Write

User name: Admin Controller type: PPM 300 DG Controller: Generator status: Switchboard control



No.	Item	Notes
1	User list and selection	Shows a list of permission users and last log on date and time. <ul style="list-style-type: none"> Green dot shows the user is currently logged on.
3	User information	Details about the selected user.
4	Options	Create a new user.
		Copy a user to a new user.
		Edit the selected user.
		Delete the selected user.
		Save the changes locally.
		Cancel the edit of a user.
		Refresh the permissions.
		Write the permissions to the controller.

9.3.5 Manage users

Create a user

1. Select  **Create** for a new user, or use  **Copy** to duplicate a user.
2. Enter the Name and optional Organisation for the user.
3. Select the group to assign to this user from the available list.
4. Enter the optional Mobile number, Direct number, Email (primary), Email (secondary) and Notes for the user.
5. Enter and confirm the Password for the user (minimum eight characters).
6. Select  **Save** to save the new user settings locally.
7. Select  **Write** to write the permissions to the controller.

Edit a user

1. Select the user.
2. Select  **Edit**.
3. Enter the user Password under Old password.
 - Use the **TAB** key on the keyboard or select outside of the password entry.
 - Enter a new password to edit the user information or change the password.
4. Select  **Save** to save the new group settings locally.
5. Select  **Write** to write the permissions to the controller.

Delete a user

A user who is a member of the Administrators group cannot be deleted.

1. Select the user to delete from the list.
2. Select  **Delete** . You are prompted to confirm the deletion.
3. Select **Yes** to delete the user.

9.4 Backup

9.4.1 About backup

You can create either a full or partial backup of the controller.

Full controller backup

Controller backups are saved as .backup files and contain all information from the controller.

- Backup files can be stored on the controller, an SD card * or locally on your computer.
- Backup files can be restored to a controller, or opened as a local file (Offline project).

NOTE * SD card is only available on ML 300 products.

Partial controller backup

Partial backups, where you can select the features to include, are saved as either .config (Configuration) files or folders.

- Partial backup files are only stored on your computer and include only the features that you want to include.

You can view and delete backups from the **Manage backups** page.

Constraints

- You can store up to 20 backup files on the controller.
- Partial backup files are only .config or folders and not .backup files.
- Partial backup files or folders can only be stored locally on your computer.
- The SD card (ML 300) must be formatted as a FAT32 file system.
- The default backup file name is *ID [Controller ID] [Controller label] (#)*, where # is a number starting at 1 from the first duplicate name.
- Deleted backup files cannot be recovered.
- The time it takes to create a backup depends on the location where the backup is saved.

9.4.2 Backup page

The screenshot shows the 'Restoring to multiple controllers' page in the DEIF PICUS 1.0.210 software. The interface includes a top navigation bar with icons for Connect, Live data, Application, Alarms, Log, I/O status, Tools (selected), Configure, and Information. The main content area is divided into two sections. The left section, titled 'Configuration', contains radio buttons for selecting the backup destination: 'Backup to controller' (selected), 'Backup to controller SD card', 'Backup to computer', and 'Partial backup'. Below these is a 'Select the backup location:' dropdown menu with the path 'C:\My documents\My ML 300 backups'. The right section, titled 'Select which controller(s) to back up:', displays a table with columns for ID, Label, Controller type, SD card, and Manage files. A single controller is listed: ID 9, Label DG 1, Controller type PPM 300 DG, and SD card Not available. A 'Manage files' icon is present next to the controller entry. At the bottom left of the configuration area is a 'Create backup' button. The bottom status bar shows the user name 'Admin', controller type 'PPM 300 DG', controller name, and generator status 'Switchboard control'.

No.	Item	Notes
1	Backup location *	<p>Select where to save a full backup.</p> <ul style="list-style-type: none"> • Backup to controller • Backup to controller SD card • Backup to computer <p>Or create a partial backup on your computer. *</p>
2	Folder location	<p> Folder location where to save the backup on your computer. Use the selection list to open a previously used location.</p>
3	Information	Additional information about the page.
4	Actions	<p> Create backup file in your selected location.</p>
5	Manage files	<p> Manage backups to open the Manage backups page. The page shows you all backups saved on the controller or SD card. You can delete backups from this page.</p>
6	Controller list	Shows all connected and logged on controllers.

NOTE * For the partial backup option, see the [Partial backup](#) page.

9.4.3 Create full backup

This information is only for creating a full backup to either controller or SD card, or your computer. For partial backup, see [Create partial backup](#).

1. Select a location to store the backup file:

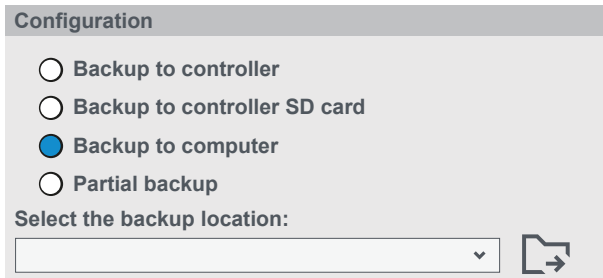

- If you select Backup to computer, then you must select a folder with either:
 - The selection list to open a previously used location.
 - **Folder** to select a location for the backup.
2. Select controllers from the controller list.



- If you select Backup to SD card, the list only shows controllers with an available SD card.
3. Select **Create backup** .
 4. Enter the Backup filename.
 5. The controller creates the backup file in the selected location.
 6. If you create backups for multiple controllers, you can stop the backup process with **Cancel**. The ongoing backup file is finished, and the controller returns to the backup page.
 7. A confirmation is shown after the backup has been created:

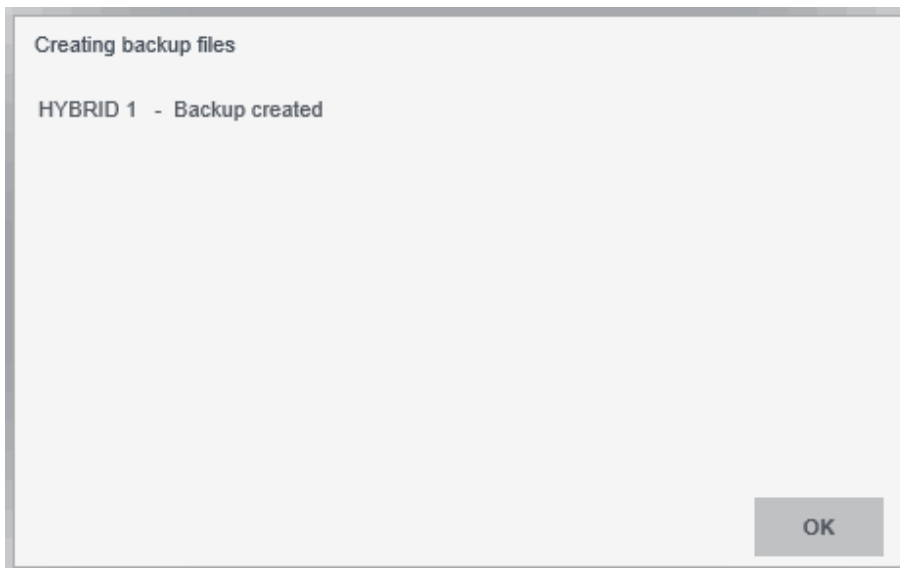

9.4.4 Partial backup page

The screenshot shows the 'Restoring to multiple controllers' page in the DEIF PICUS 1.0.21.0 software. The interface includes a top navigation bar with icons for Connect, Live data, Application, Alarms, Log, I/O status, Tools, Configure, and Information. The main content area is divided into three sections:

- Configuration:** Contains radio buttons for 'Backup to controller', 'Backup to controller SD card', 'Backup to computer', and 'Partial backup' (selected). Below this is a 'Select the backup location:' section with a folder path dropdown (C:\My documents\My ML 300 backups) and a file type dropdown (.config).
- Information:** Provides instructions on how to add controllers and select features for backup. It states: 'Remember, if you add more controllers to the partial backup, make sure to only select the required features on each add controller that you want to backup.'
- Actions:** Contains a 'Create backup' button.

Two tables are present:

Select which controller(s) to back up:				
ID	Label	Controller type	SD card	Manage files
<input checked="" type="checkbox"/>	9	DG 1	PPM 300 DG	Not available
<input checked="" type="checkbox"/>	4	DG 1	PPM 300 DG	Not available

Select feature to backup	
<input checked="" type="checkbox"/>	Permissions
<input checked="" type="checkbox"/>	Communication (Controller ID, port, and network settings)
<input type="checkbox"/>	Single-line
<input type="checkbox"/>	Input/Output
<input type="checkbox"/>	Parameters
<input checked="" type="checkbox"/>	Date and Time
<input type="checkbox"/>	View Design
<input type="checkbox"/>	CustomLogic
<input type="checkbox"/>	Modbus

At the bottom, a status bar shows: User name: Admin; Controller type: PPM 300 DG; Controller: [selected]; Generator status: Switchboard control.

No.	Item	Notes
1	Partial backup	Select this for only a partial backup.
2	Folder location	Folder location where to save the backup on your computer. Use the selection list to open a previously used location.
3	Type of partial backup	Select either: <ul style="list-style-type: none"> .config (Configuration file) Folder
4	Actions	Create backup file in your selected location.
5	Manage files	Manage backups to open the Manage backups page. The page shows you all backups saved on the controller or SD card. You can delete backups from this page.
6	Controller list	Shows all connected and logged on controllers.
7	Partial backup features	Select the features you want to include in the partial backup. *

NOTE * If you add more controllers to the partial backup, make sure to only select the required features on each add controller that you want to backup. If you select some features on one controller and then add another controller without selecting features, the backup contains a combination of selected features and all features from the other controller.

9.4.5 Create partial backup

This information is only for creating a partial backup to your computer. For a full backup to either controller or SD card, or your computer, see Create full backup.

1. Select partial backup:

The Configuration dialog box shows four radio button options: Backup to controller, Backup to controller SD card, Backup to computer, and Partial backup. The Partial backup option is selected. Below the options, there is a section titled 'Select the backup location:' with a text box containing 'C:\My documents\My ML 300 backups' and a folder icon button. Below that is a dropdown menu showing '.config'.

2. Select the backup location on your computer with either:

- The selection list to open a previously used location.
- **Folder** to select a location for the backup.

3. Select the type of partial backup:

- .config for a configuration file
- Folder for a folder

4. Select controllers from the controller list.

Select which controller(s) to back up:

<input type="checkbox"/>	ID	Label	Controller type	SD card	Manage files
<input checked="" type="checkbox"/>	9	DG 1	PPM 300 DG	Available	

5. Select the features you want to include in the partial backup:

The Select feature to backup dialog box has a title bar and a list of features with checkboxes. The 'Permissions' feature is selected and highlighted in blue. Other features include Communication (Controller ID, port, and network settings), Single-line, Input/Output, Parameters, Date and Time, View Design, CustomLogic, and Modbus.

6. Select **Create backup** .

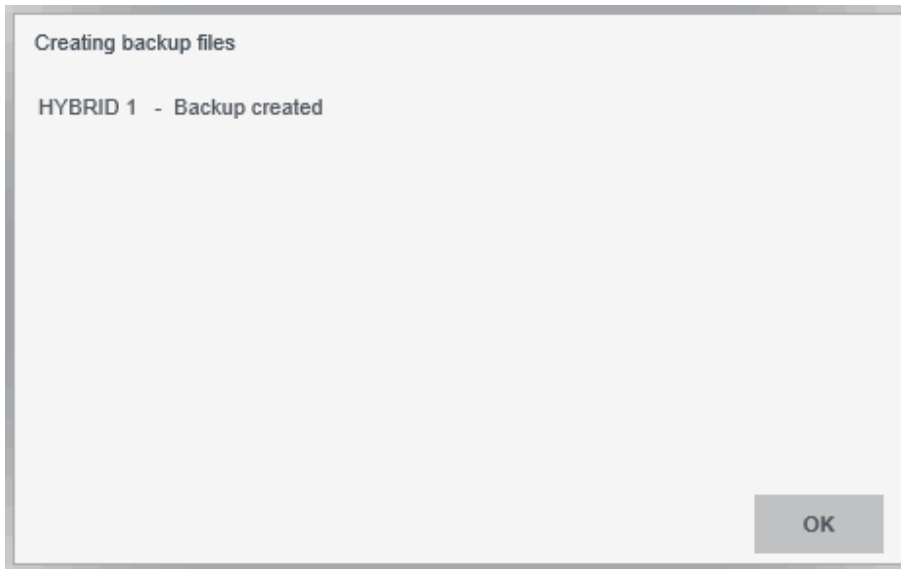

-
- The controller creates the partial backup file in the selected location.
- If you create backups for multiple controllers, you can stop the backup process with **Cancel**. The ongoing backup file is finished, and the controller returns to the backup page.

9.4.6 Manage backups page

Manage backup files

Information

The screen shows all the backup files that are stored on the controller and the controller's SD card.

To permanently delete one or more backup files, select the files that you want to delete and then select Delete.

Warning! Deleted backup files cannot be recovered.

Select Back to return to the Backup page.

Files on the controller : ID 9 DG 1

<input type="checkbox"/>	Name	Controller type	Software version	Creation date	Location
<input checked="" type="checkbox"/>	ID 9 DG 1 backup	PPM 300 DG	1.0.12.0	2020-01-01 22:53:35	BU
<input type="checkbox"/>	ID 9 DG 1 (1) backup	PPM 300 DG	1.0.12.0	2020-01-01 23:25:16	SD_CARD

Actions

Delete file Back

User name: Admin Controller type: PPM 300 DG Controller: Generator status: Switchboard control

No.	Item	Notes
1	Information	Additional information about the page.
2	Actions	<input type="checkbox"/> Delete file the selected files. <input type="checkbox"/> Back to the Backup page.
3	Backup list	Shows backups that are stored on the controller or SD card.

9.4.7 Delete backup

Deleted backup files cannot be recovered.

1. Select the backup files to delete.

Files on the controller : ID 9 DG 1

<input type="checkbox"/>	Name	Controller type	Software version	Creation date	Location
<input type="checkbox"/>	ID 9 DG 1.backup	DG	1.0.8.0-dev	2018-08-30 15:08:54.000	BU
<input type="checkbox"/>	ID 9 DG 1 (1).backup	DG	1.0.8.0-dev	2018-08-31 14:51:25.000	BU
<input checked="" type="checkbox"/>	ID 9 DG 1.backup	DG	1.0.8.0-dev	2018-08-29 10:06:18.000	SD_CARD
<input checked="" type="checkbox"/>	ID 9 DG 1 (2).backup	DG	1.0.8.0-dev	2018-09-04 11:56:28.000	SD_CARD
<input type="checkbox"/>	ID 9 DG 1 (3).backup	DG	1.0.8.0-dev	2018-09-05 08:59:44.000	SD_CARD
<input type="checkbox"/>	ID 9 DG 1 (4).backup	DG	1.0.8.0-dev	2018-09-05 09:00:55.000	SD_CARD

2. Select  **Delete file** .

- You are prompted to confirm that you want to delete the selected files.

Confirmation

Are you sure you want to delete backup file?

- Select **Yes** to delete the files.
- Select **No** to cancel.

9.5 Restore configuration

9.5.1 About restore configuration

You can restore configuration files (.config) or folders to one or more controllers.

When you restore or broadcast a configuration, the data on the controllers is replaced by the configuration data.

9.5.2 Restore configuration constraints

Controller prerequisites

Before you can restore or broadcast a configuration (file or folder), the controller must meet certain prerequisites. If the controller is in Emulation mode, these constraints do not apply.

Breaker constraint

All controlled breaker(s) must be opened.

Equipment constraint (if controlled)

The controlled equipment must be stopped.

Mode constraint (PPM 300 or PPU 300)

The controller must be in Switchboard control.

Not compatible configuration files

Configuration files or folders might not be compatible with the current controller configuration if:

- The configuration is from a different product type.
- The configuration is from a different controller type.
- The configuration is from a different controller configuration.
- The configuration is from a controller with a different hardware configuration.
- The configuration is not supported by the current controller software.

NOTICE





Data not restored

When you restore a backup file or folder to a controller, the event log and alarms are **not** restored.

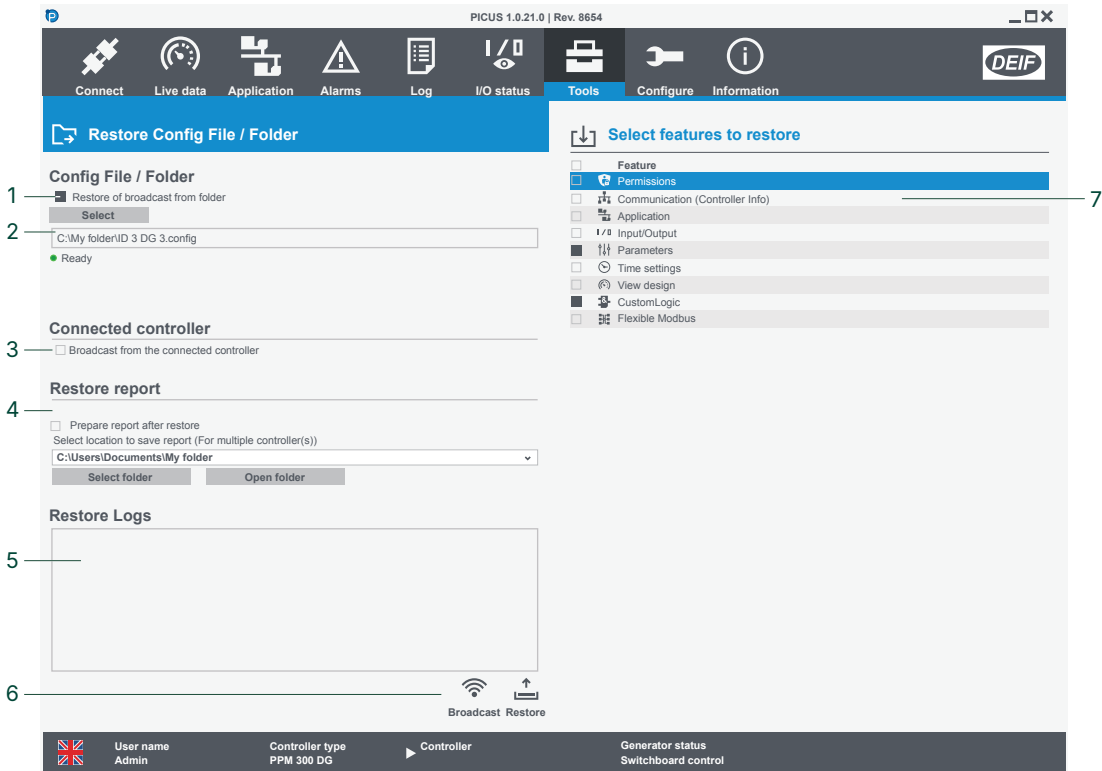
9.5.3 Restore configuration page



No.	Item	Notes
1	Restore or broadcast from folder	Restore or broadcast from a file or folder.
2	File or folder	The file or folder selected for restore or broadcast.
3	Broadcast from connected controller	Broadcast features from the connected controller.
4	Restore report	Select to create a restore report in the location selected.
5	Restore log	Log of restore actions.
6	Options	 Broadcast the features.  Restore the features.
7	Feature selection	The features you can select to restore or broadcast. *

NOTE * You cannot broadcast Flexible Modbus or CODESYS features.

9.5.4 Broadcast or restore a configuration

Before you restore or broadcast a configuration, make sure all the prerequisites are met.

Broadcast from controller

1. Select **Broadcast from the connected controller**:

Connected controller

- Broadcast from the connected controller

2. Select the features that you wish to restore: *

Select features to restore

<input type="checkbox"/>	Feature
<input checked="" type="checkbox"/>	Permissions
<input type="checkbox"/>	Single-line
<input type="checkbox"/>	Input/Output
<input type="checkbox"/>	Parameters
<input type="checkbox"/>	Date and Time
<input checked="" type="checkbox"/>	View Design
<input type="checkbox"/>	Custom Logic

3. Select  **Broadcast** and select the controllers you wish to broadcast to.

NOTE * You cannot broadcast Flexible modbus or CODESYS features.

Restore or broadcast from a configuration file or folder

1. Select **Restore or broadcast from folder**:

Config File / Folder

- Restore or broadcast from folder

2. Use **Select** to find the location of your configuration file or folder:

Select



C:\My folder\ID 3 DG 3.config

3. Select the features that you wish to restore:

Select features to restore

<input type="checkbox"/>	Feature
<input checked="" type="checkbox"/>	Permissions
<input type="checkbox"/>	Communication (Controller Info)
<input type="checkbox"/>	Single-line
<input checked="" type="checkbox"/>	Input/Output
<input checked="" type="checkbox"/>	Parameters
<input type="checkbox"/>	Date and Time
<input type="checkbox"/>	View Design
<input type="checkbox"/>	Custom Logic
<input type="checkbox"/>	Flexible Modbus

4. Select either:

-  **Broadcast** to broadcast the configuration file or folder and the selected features to the selected controllers.
-  **Restore** to restore the configuration file or folder and the selected features to the currently connected controller.

9.6 Restore

9.6.1 About restore

You can restore backup files or backup folders made before PICUS version 1.0.8.0. You can restore from the controller, an SD card, or from your computer.

Data restored

These backup data are always restored:

- Permissions
- Texts
- Date and time
- Parameters
- Input/Output
- CustomLogic
- Single-line
- Modbus

You can also select optional data to restore on the restore page.

9.6.2 Restore constraints

Controller prerequisites

Before you restore a backup to a controller, the controller must meet certain prerequisites. If the controller is in Emulation mode, these constraints do not apply.

Breaker constraint

All controlled breaker(s) must be opened.

Equipment constraint (if controlled)

The controlled equipment must be stopped.

Mode constraint (PPM 300 or PPU 300)

The controller must be in Switchboard control.

Not compatible configuration files

Configuration files or folders might not be compatible with the current controller configuration if:

- The configuration is from a different product type.
- The configuration is from a different controller type.
- The configuration is from a different controller configuration.
- The configuration is from a controller with a different hardware configuration.
- The configuration is not supported by the current controller software.

Restore network settings

If you use **Restore IP address (IPv4) and controller ID**, the controller **must** be powered off and powered on before the network settings are restored.



CAUTION



Controller part of network chain communication

If the controller the only connection point between other controllers, when the controller is powered off, the connection through the controller will be disrupted. Check that this will not affect your system before you power off the controller. This does not affect a Star connection topology.

NOTICE



Data not restored

When you restore a backup file or folder to a controller, the event log and alarms are **not** restored.

9.6.3 Restore page

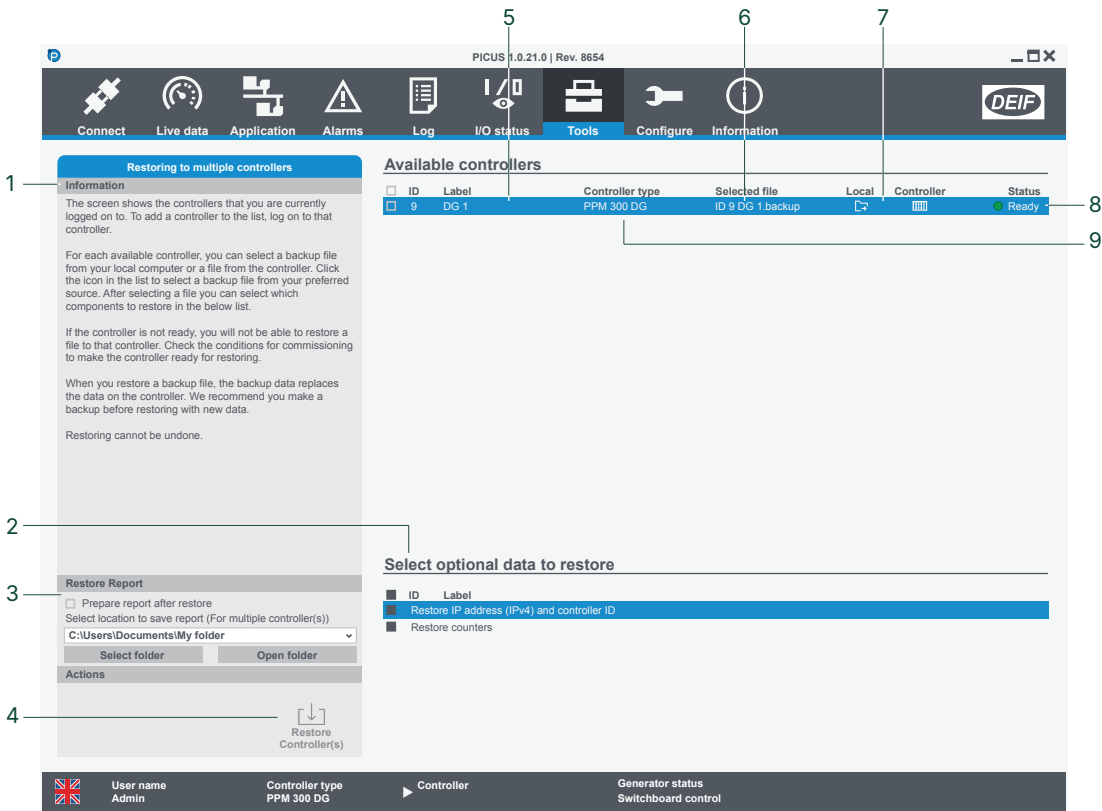

No.	Item	Notes
1	Information	Additional information about the page.
2	Data selection	Select additional data to restore (only shown after you select a backup file to restore).
3	Restore report	Select to create a restore report in the location selected.
4	Actions	Restore controller(s) to restore the data selection, to the selected controllers.
5	Controller list	Shows all connected and logged on controllers.
6	Selected file	Shows the backup that you selected to restore.
7	Backup locations	Local to select a backup file from your computer. Controller to select a backup file from the controller or SD card.
8	Status	Shows the ready status: Ready for restore. Not ready to restore. *
9	Controller list	Shows all connected and logged on controllers.

NOTE * Not ready to restore because one or more prerequisites have not been met. For example, the breaker is not in the open state.

9.6.4 Restore a backup

Before you restore a backup, you must make sure all the prerequisites are met.

Restore from your computer

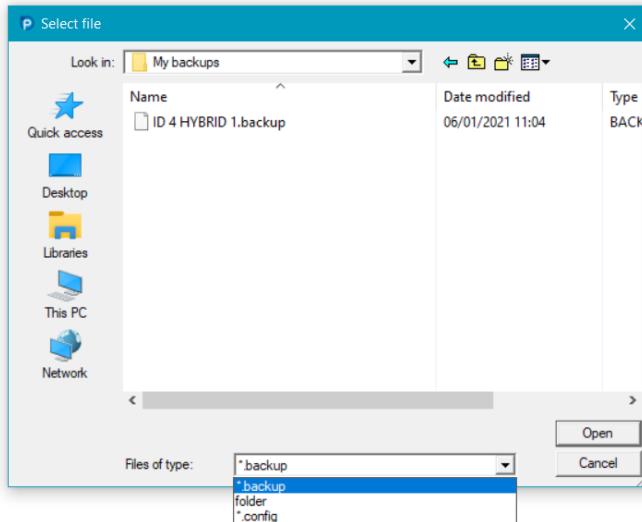

1. Select  **Local**.

- You are prompted to select the backup or backup folder:



- Use the **Files of type** drop-down list to change the type of backup file you want to restore.
 - *.config** files were converted from .backup files with PICUS version 1.0.9.0 and later.
 - *.backup** backup files were created with PICUS version 1.0.8.0 and later.
 - folder** backup folders were created with PICUS version 1.0.7.x and earlier.
2. Select the backup and select **Open**.
- The controller checks if the selected backup file is valid.
 - If the backup file is not valid, you are informed why it is not valid and you can select a different backup file.
3. Select the optional data to restore.
4. Select the controllers you want to restore (you can only select controllers that already have a backup file selected).
5. Select  **Restore controller(s)**.
- The controller restarts.
 - You are logged out of the controller when the backup file or folder is restored.
 - If you selected optional data **Restore IP address (IPv4) and controller ID**, the controller must be powered off and powered on manually before the network settings are updated.

Restore from the controller

1. Select  **Controller** to select a backup stored on the controller or SD card.
2. Select the backup you want to restore and select  **Use selected backup**.
- The controller checks if the selected backup file is valid.
 - If the backup file is not valid, you are informed why it is not valid and you can select a different backup file.
3. Select the optional data to restore.
4. Select the controllers you want to restore (you can only select controllers that already have a backup file selected).
5. Select  **Restore controller(s)**.
- The controller restarts.
 - You are logged out of the controller when the backup file or folder is restored.
 - If you selected **Restore IP address (IPv4) and controller ID**, then the controller must be powered off and powered on manually before the network settings are updated.

9.7 Firmware

9.7.1 About firmware

Use the firmware feature to update your controllers and displays. *

NOTE * Some products do not have separate displays.

Download firmware

Firmware for your product is available on www.deif.com.

iE 250 LAND: <https://www.deif.com/software/?product=17655>

iE 250 MARINE: <https://www.deif.com/software/?product=20133>

iE 350 MARINE: <https://www.deif.com/software/?product=20135>

PPM 300: <https://www.deif.com/software/?product=1293>

PPU 300: <https://www.deif.com/software/?product=1688>

GPU 300: <https://www.deif.com/software/?product=2438>

GPC 300: <https://www.deif.com/software/?product=36765>

1. Use the link for your product to download the controller firmware.
2. Follow the instructions for how to download.
3. Unzip the file to a location on your computer.

9.7.2 Firmware constraints

Controller prerequisites

Before you can apply a firmware update, the controller must meet certain prerequisites. If the controller is in Emulation mode, or has an ID of **0** (and not part of the system), these constraints do not apply.

Breaker constraint

All controlled breaker(s) must be opened.

Equipment constraint (if controlled)

The controlled equipment must be stopped.

Mode constraint (PPM 300 or PPU 300)

The controller must be in Switchboard control.

9.7.3 Update controller page

The screenshot shows the 'Update' page in the PICUS software. It features a table of controllers with columns for ID, Host name, Label, Progress, and Ready. A table below shows application versions for BL Image, OS Image, DL Image, App, and Version-Method. At the bottom, there are 'Check ready' and 'Update' buttons. The interface is annotated with numbers 1 through 9 pointing to various elements.

No.	Item	Notes		
1	Controller or display	Changes to the controller or display * update page.		
2	Controller list	Shows all the controllers available for update.		
3	Update progress	Progress bar shows how far the update has progressed.		
4	Connection state	Shows the ready status of the ML 300 controller. <table border="0" style="width: 100%;"> <tr> <td style="text-align: center;">● Ready to update.</td> <td style="text-align: center;">● Not ready to update.</td> </tr> </table>	● Ready to update.	● Not ready to update.
● Ready to update.	● Not ready to update.			
5	Update information	Shows the progress of the update.		
6	Select firmware	Select the firmware package.		
7	Firmware location	Shows the location of the selected firmware package.		
8	Application versions	Shows the version information of the controller (target) and the selected firmware package.		
9	Actions	<table border="0" style="width: 100%;"> <tr> <td style="text-align: center;">🔄 Check ready status of ML 300 the controller.</td> <td style="text-align: center;">⬇️ Update the selected controllers.</td> </tr> </table>	🔄 Check ready status of ML 300 the controller.	⬇️ Update the selected controllers.
🔄 Check ready status of ML 300 the controller.	⬇️ Update the selected controllers.			

NOTE * Display is only for ML 300 controllers.





9.7.4 Update display page (GPU/GPC/PPU/PPM)

The screenshot shows the 'Update' page in the PICUS 1.0.21.0 software. The interface is divided into several sections:

- 1**: Controller or display update page (the 'Update' tab).
- 2**: Display list (a table with columns for Host name and Progress).
- 3**: Update progress (a progress bar for the selected display).
- 4**: Update information (a large empty box for details).
- 5**: Select firmware (a dropdown menu).
- 6**: Firmware location (a text field showing the file path).
- 7**: Application versions (a table with columns for Description, Target version, Package version, and Status).
- 8**: Actions (an 'Update' button with a download icon).

No.	Item	Notes
1	Controller or display	Changes to the controller or display update page.
2	Display list	Shows all the displays available for update.
3	Update progress	Progress bar shows how far the update has progressed.
4	Update information	Shows the progress of the update.
5	Select firmware	Select the firmware package.
6	Firmware location	Shows the location of the selected firmware package.
7	Application versions	Shows the version information of the display (target) and the selected firmware package.
8	Actions	 Update the selected displays.

9.7.5 Install firmware

1. Make sure you meet the [Firmware update prerequisites](#).
2. Select Controller or Display as necessary.
3. Select the controllers (or displays) that you wish to update.
4. Use **Select** to locate the downloaded firmware update **.packet** file.
 - PICUS automatically checks the status of the firmware package and selected controllers or displays.
5. To update a controller, use  **Check ready** to check if the controller is ready to be updated:
 -  = the controller is ready.
 -  = the controller is not ready. Check if you have met the installation prerequisites.
6. Select  **Update** to start.
 - During the update the progress status is shown and also by a progress bar.
7. When a controller update is complete, PICUS may restart.

9.8 Trending

9.8.1 Record page

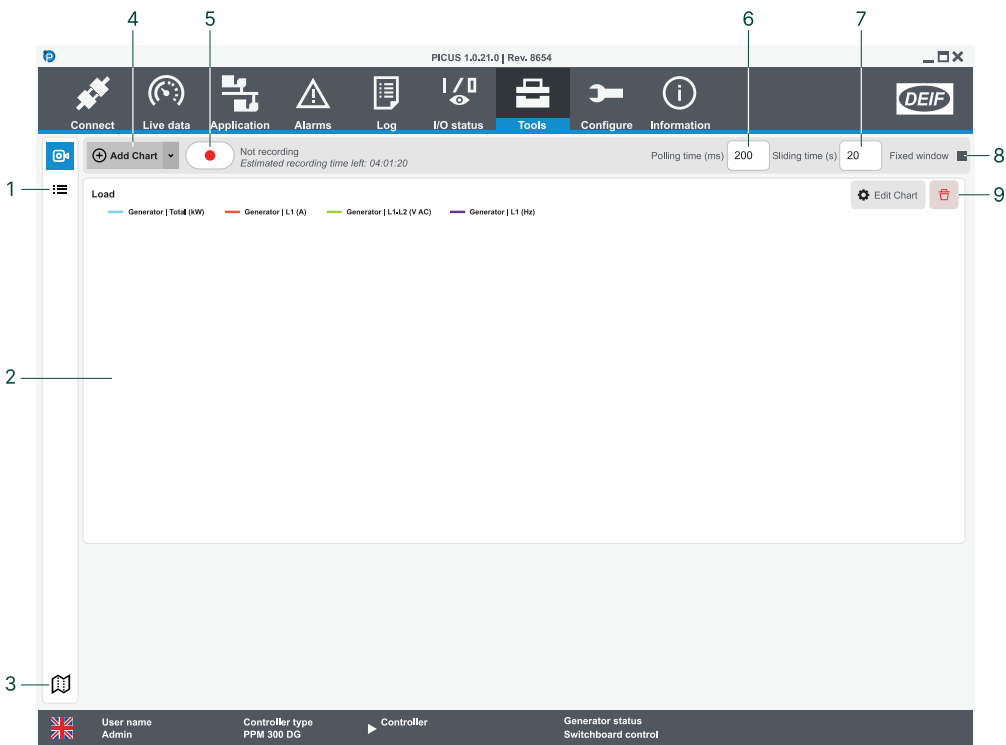

No.	Item	Notes
1	View recordings	Recordings : Shows a list of saved recordings to duplicate, edit, delete or export.
2	Charts	Shows the charts to use during the next recording.
3	Map	Map : Shows the timeline for the entire recording and allows selection of a block to zoom in.
4	Add or select chart	Add chart to select value traces for the recording. Or use to select a previously created chart.
5	Record	Record starts the recording of all the charts.
6	Polling time	The polling time to use between recording trace values.
7	Sliding time	The time range to be displayed on the page.
8	Fixed window	Whether to keep the chart within the area displayed and stored or allow the recording to scroll.
9	Chart actions	Edit chart : To configure the trace values. Delete : removes the chart from the recording.

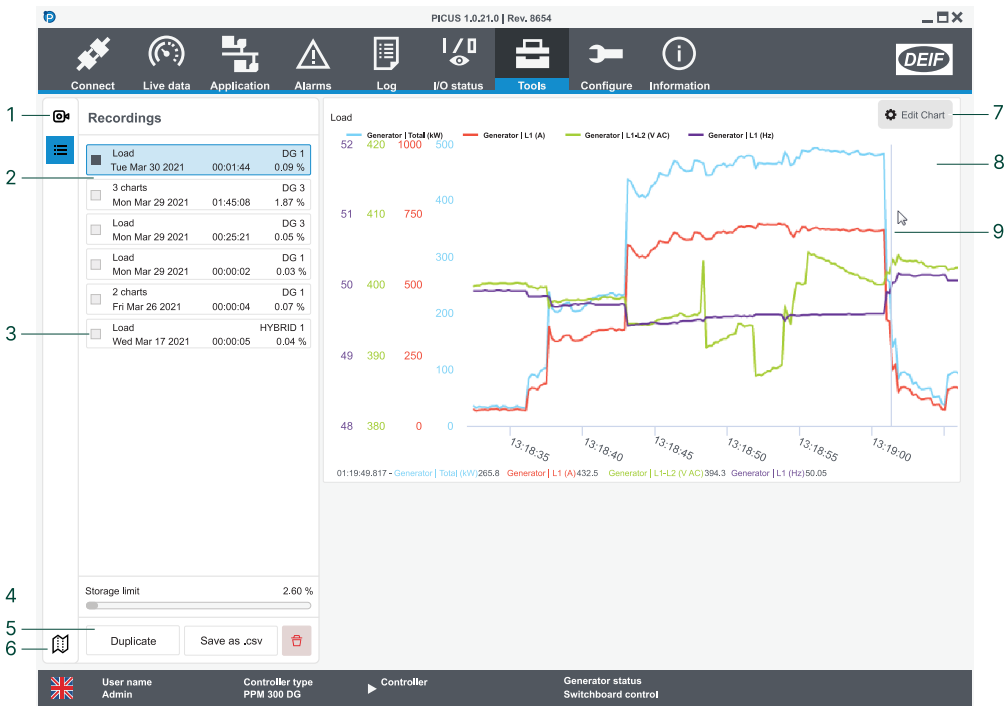

9.8.2 Recordings page



No.	Item	Notes
1	Record	Record : Shows the recording page to create a recording of trace values.
2	Previous recordings	Shows a list of previous recording sessions.
3	Selection	Selects the recording session to use with actions below.
4	Storage limit	Shows the storage amount used for all recordings.
5	Recording actions	Duplicate : Uses the recording session for a new recording.
		Delete : Removes recording.
5	Recording actions	Save as .csv : Exports the recording values in a comma separated value file.
6	Map	Map : Shows the timeline for the entire recording and allows selection of a block to zoom in.
7	Edit chart	Edit chart : To configure the trace values.
8	Recorded chart	Shows the recorded trace values for the chart.
9	Selection line	A selection line to see the trace values for the specific point in the recording.

9.9 Regulator status

9.9.1 Regulator status page

No.	Item	Notes
1	GOV status	Shows information on GOV regulation mode, set point, source, manual input, external offset, values, and output.
2	AVR status	Shows information on AVR regulation mode, set point, source, manual input, external offset, values, and output.
3	Actions	 Expand all : Expands all items in the list.  Collapse all : Collapses all items in the list.

9.10 Report

9.10.1 Report page

The screenshot shows the DEIF PICUS 1.0.21.0 software interface. The top navigation bar includes icons for Connect, Live data, Application, Alarms, Log, I/O status, Tools, Configure, and Information. The 'Tools' menu is active, displaying a 'Select content to print' dialog. This dialog has a list of content categories with checkboxes: Application (checked), Communication, I/O configuration, Parameters, Time settings, CustomLogic, Software versions, and Permissions. Below the list are 'Print' and 'Commissioning' buttons. The bottom status bar shows the user name 'Admin', controller type 'PPM 300 DG', controller 'Switchboard control', and generator status 'Switchboard control'.

No.	Item	Notes
1	Content to print	<input checked="" type="checkbox"/> Selected : includes content in report. <input type="checkbox"/> Not selected : excludes content in report.
2	Print	Produce and print a full report of the selected content.
	Commissioning	Produce and print a commissioning report of the selected content. This report only includes information about enabled alarms.

9.10.2 Report preview page

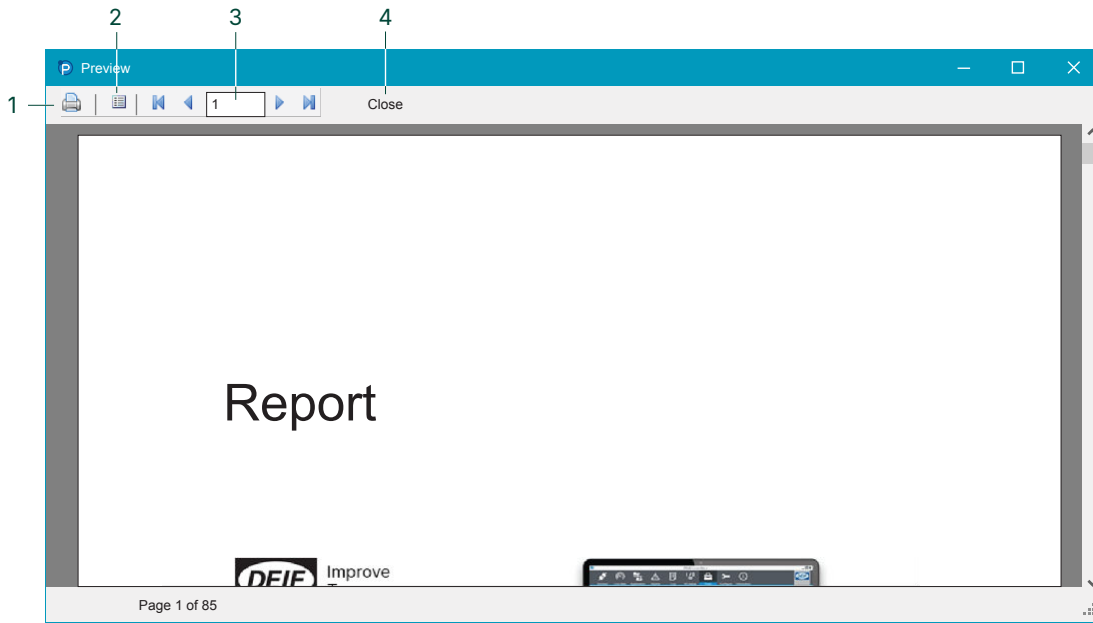

No.	Item	Notes
1	Print	Print the report.
2	Thumbnails	Toggle the view of thumbnail pages.
3	Page view	Page view options.
4	Close	Close the report preview.

10. Configure

10.1 Parameters

10.1.1 Parameters page

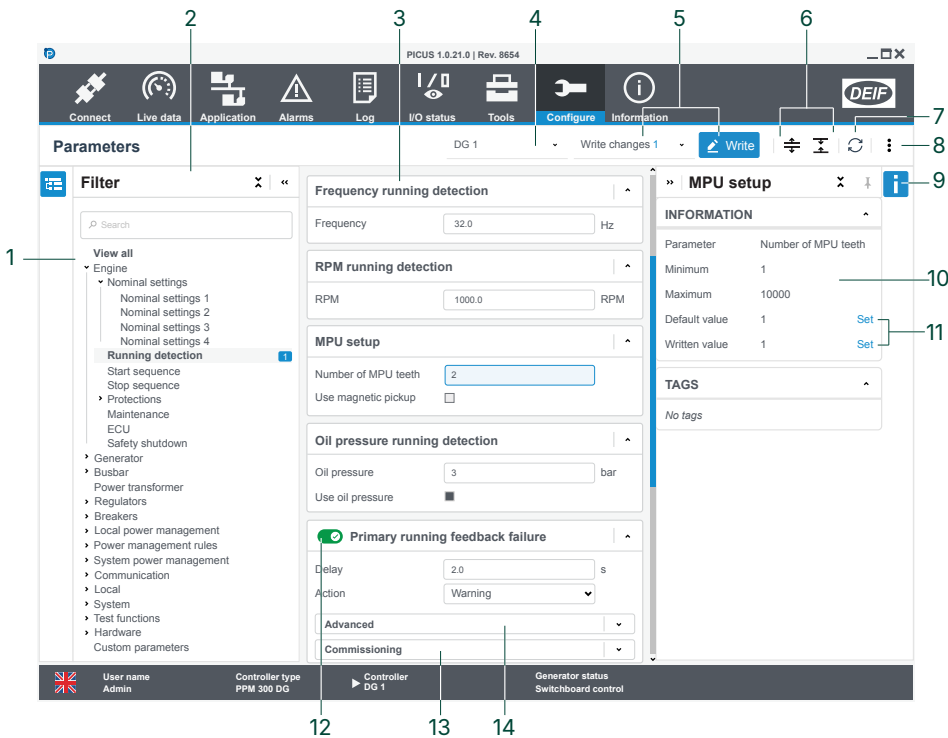

No.	Item	Notes
1	Parameter category list	Shows a list of the parameters organised by category. Highlight shows selected parameter and any unwritten changes.
2	Search filter	Keyword search on parameter name.
3	Parameter settings	The parameter settings in the category.
4	Selected controller(s)	Select one or more connected controllers. Any unsupported parameters are ignored.
5		Write selected changes or Write all changes. You can also review changes to undo them if needed.
6	Expand/Collapse	Expand all : items in the list. Collapse all : items in the list.
7	Refresh	Refresh : parameter settings.
8	More options	<ul style="list-style-type: none"> Auto refresh Show path Auto expand advanced Expand none on load Expand first on load
9		Show or hide the parameter information.
10	Parameter range	Shows Minimum, Maximum, default value, and written value.
11	Set value	Change value to either default value or last written value.
12	Enable	Enable or Not enable the parameter or alarm.

No.	Item	Notes
13	Commissioning	View value, alarm state, inhibit state, reset or view counter, and test alarm.
14	Advanced	Additional parameter configuration settings.

10.1.2 Parameter curve page

No.	Item	Notes
1	Selected parameter	Highlight shows selected parameter and any unwritten changes.
2	Curve	Shows curve settings as a graph.
3	Set value	Change value to either default value or last written value.
4	Table	Shows curve settings as a table.
5	Delete row	 Delete the table row.
6	Add row	Adds a row to the table.

NOTE Some parameter curves are only shown if the corresponding input/output function is configured. Some parameter curves must be enabled to be active.

10.1.3 Review changes

You can review all of the session changes before they are written to the controller(s). You can clear an individual change or all of the changes.

1. Select the changes number:

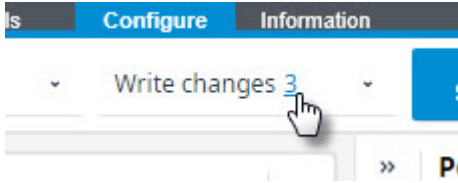

2. A summary of the changes is shown:

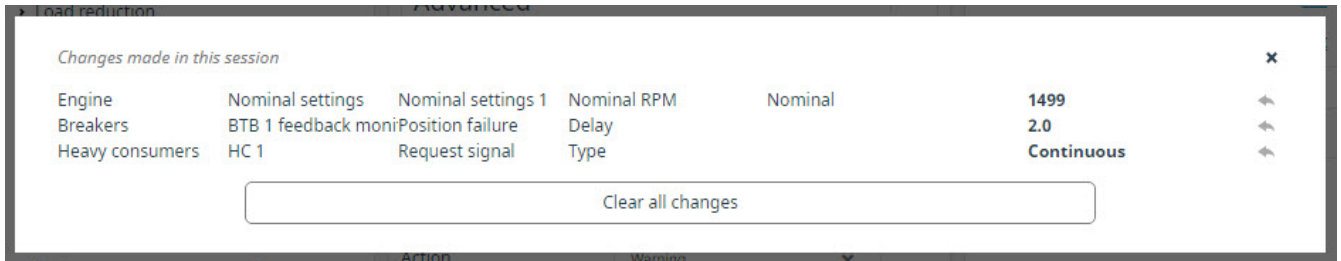

Clear an individual change

1. Select **Undo** against the parameter change to clear:

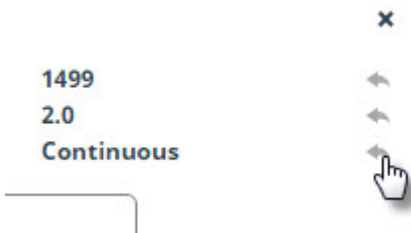

Clear all changes

1. Select **Clear all changes** to clear all of the parameter changes:

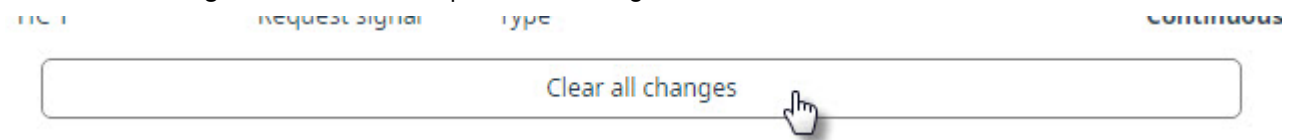

10.1.4 Write changes or all

You can choose to either write either only the changed parameters, or all parameters to the controller(s).

1. Select **Write changes**:

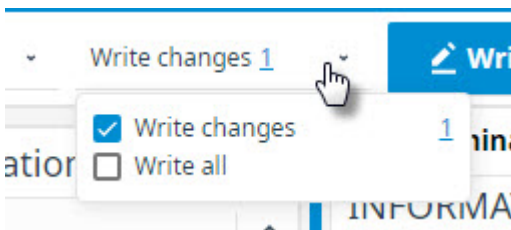

2. Select either:

- **Write changes** : to save only changed parameters.
- **Write all** : to save all parameters.

3. Select  **Write** to write the parameters to the controller(s).

10.1.5 Reset counter

1. Select the parameter from the list.
2. Open **Commissioning** in the parameter.
3. Enter the **Reset counter value**.
4. Select **Write** .

10.1.6 Alarm test



Active alarm actions (protections)

Activating an alarm test also activates the alarm actions. Only test alarms if it is safe.

The alarm remains active for as long as the alarm test is running. Stop the alarm test and acknowledge the alarm to change the state of the alarm to inactive.

1. Select the parameter from the list.
2. Open **Commissioning** in the parameter.
3. Under Alarm test, select **Start test**.
 - The **Alarm test** parameter changes to **Stop test** while an alarm test is running.
4. Select **Stop test** to stop the alarm test.

10.2 Input/output

10.2.1 About input or output channels

The controller channels are configurable but depend on the controller type, parameters, functions and alarms available. Some hardware types support bi-directional channels, where you can configure if the channel is input or output.



More information

See the **Technical specifications** in the [Data sheet](#) for the hardware specifications and terminal allocations for the controller.

Input/output constraints

Channel	Function and/or alarm	Constraints
Digital input	1 or more function 1 or more custom alarm	<ul style="list-style-type: none">You cannot use a function already assigned to another digital input (DI).You cannot use a function assigned and used in CustomLogic.
Digital output	1 function or 1 or more custom alarm(s)	<ul style="list-style-type: none">Only one function or multiple alarms are allowed to be configured.You cannot use a function assigned and used in CustomLogic.The same function can be assigned to other digital output (DO) terminals.
Analogue input	1 function 1 Above range alarm 1 Below range alarm 1 or more custom alarm(s)	<ul style="list-style-type: none">Functions must use the same unit of measure.You cannot use a function already assigned to another analogue input (AI).The selected functions type can either be:<ul style="list-style-type: none">Analogue input (Analogue functions).orDigital input (Supervised binary input).You cannot use both analogue AND digital functions on the same terminal.
Analogue output or PWM	1 function	<ul style="list-style-type: none">The function must be selected before the Output setup can be configured.The same function can be assigned to other Pulse width modulation (PWM) terminals.

10.2.2 I/O configuration

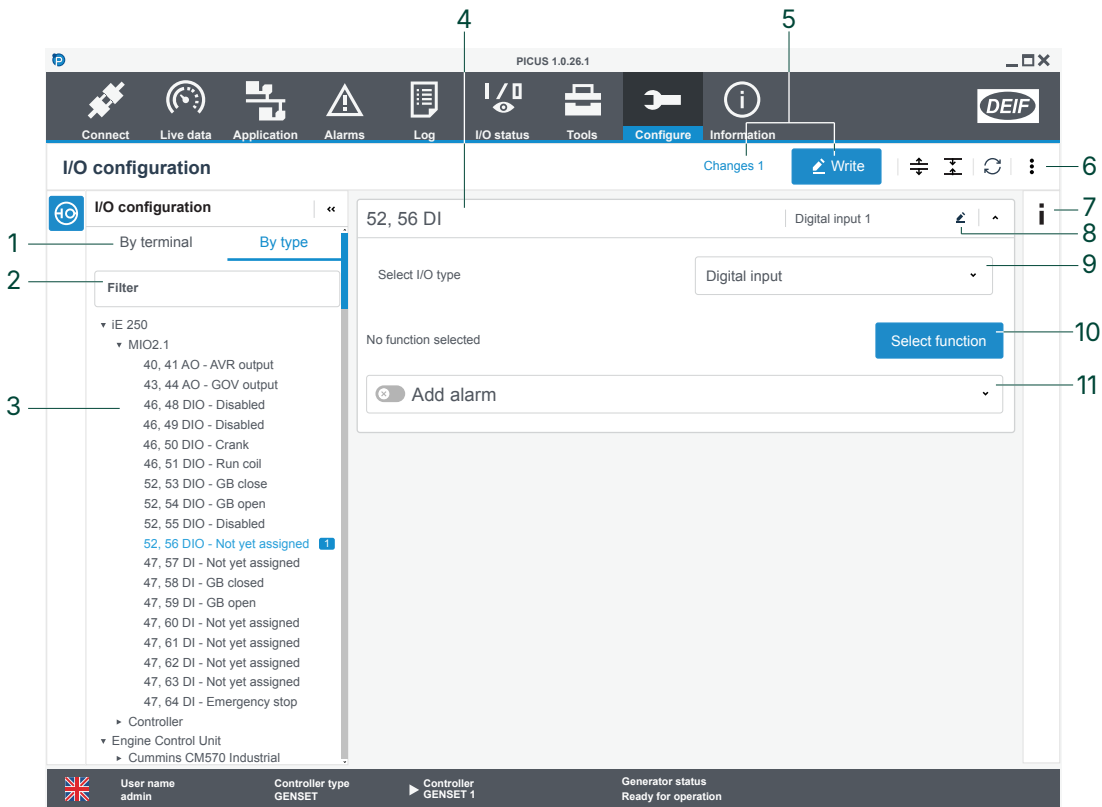

No.	Item	Notes
1	Terminal or type	Display list as by terminal or type.
2	Filter	Filter the list by a search term.
3	Hardware and list	List of channels for each hardware.
4	Channel	Selected channel settings.
5	Changes #	Shows number of changes.
	Write	Write the configuration to the controller.
6	Actions	Expand all : Expands all items in the list. Collapse all : Collapses all items in the list.
		Refresh : Reload configuration. More : Additional settings.
	More : Additional settings.	<ul style="list-style-type: none"> • Auto refresh • Show path • Auto expand advanced
7	Information	Information : Details about the terminal type.
8	Channel name	Edit the channel name.
9	Channel direction	Select either input or output.
10	Function selection	Select the function for the terminal.
11	Custom alarm	Add or edit custom alarms.

10.3 Display designer

10.3.1 About Display designer

Use the Display designer to create and edit both dashboards and the header shown on the controller display. Simply drag and drop the elements to the page.

Example display dashboard

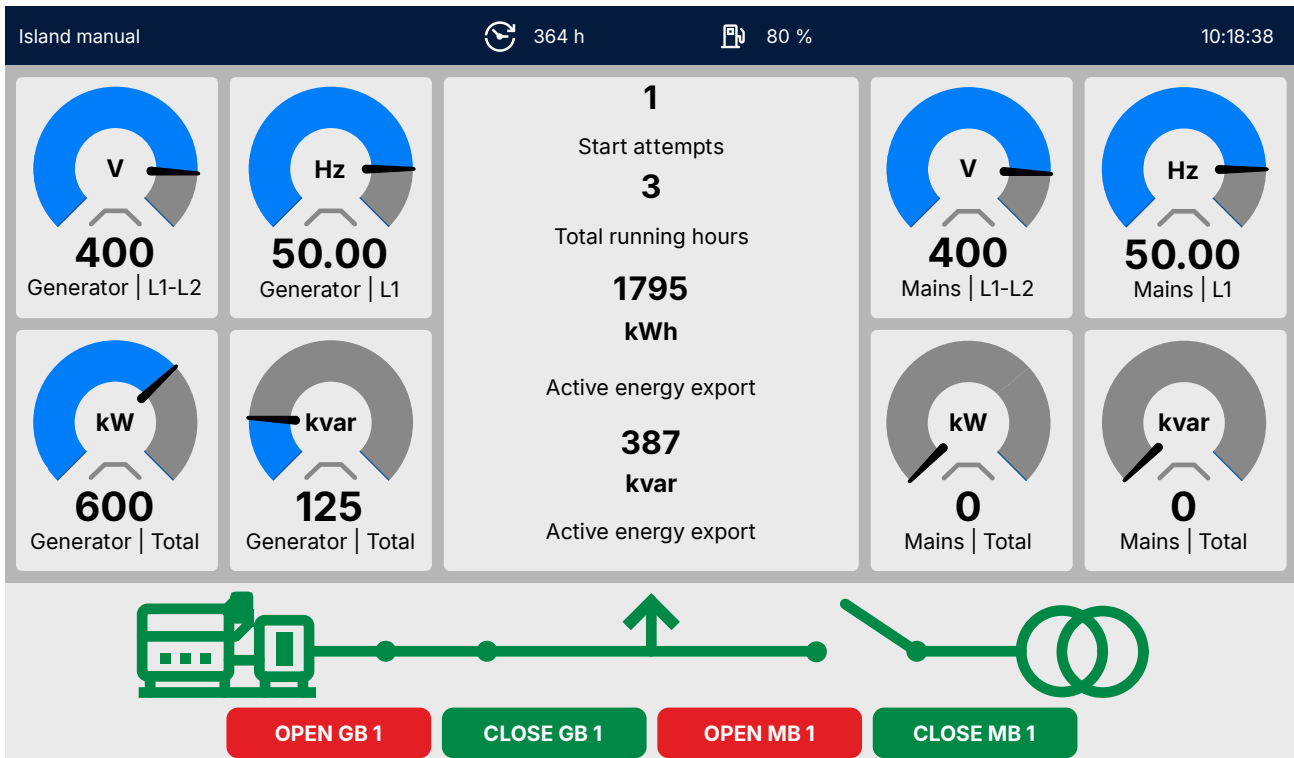

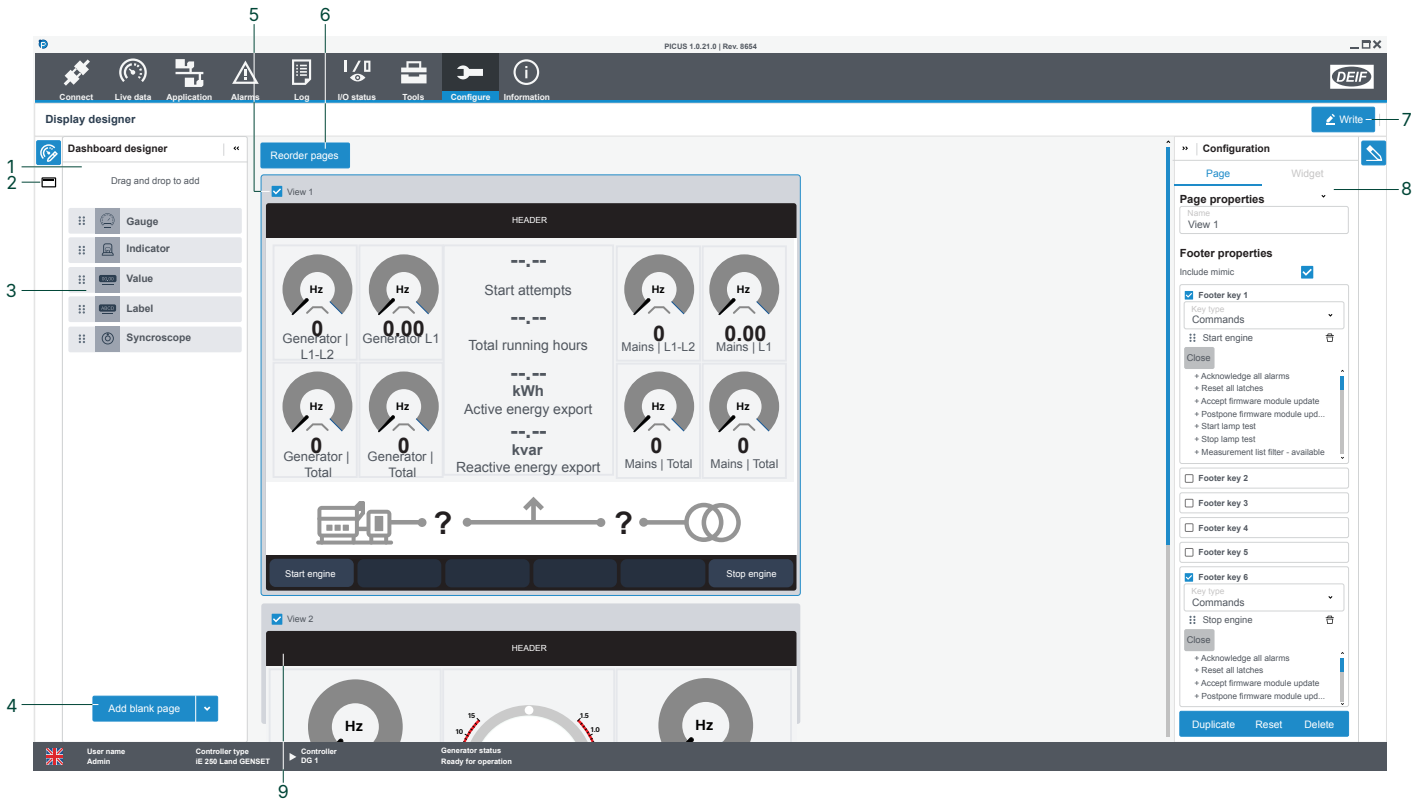

10.3.2 Display designer

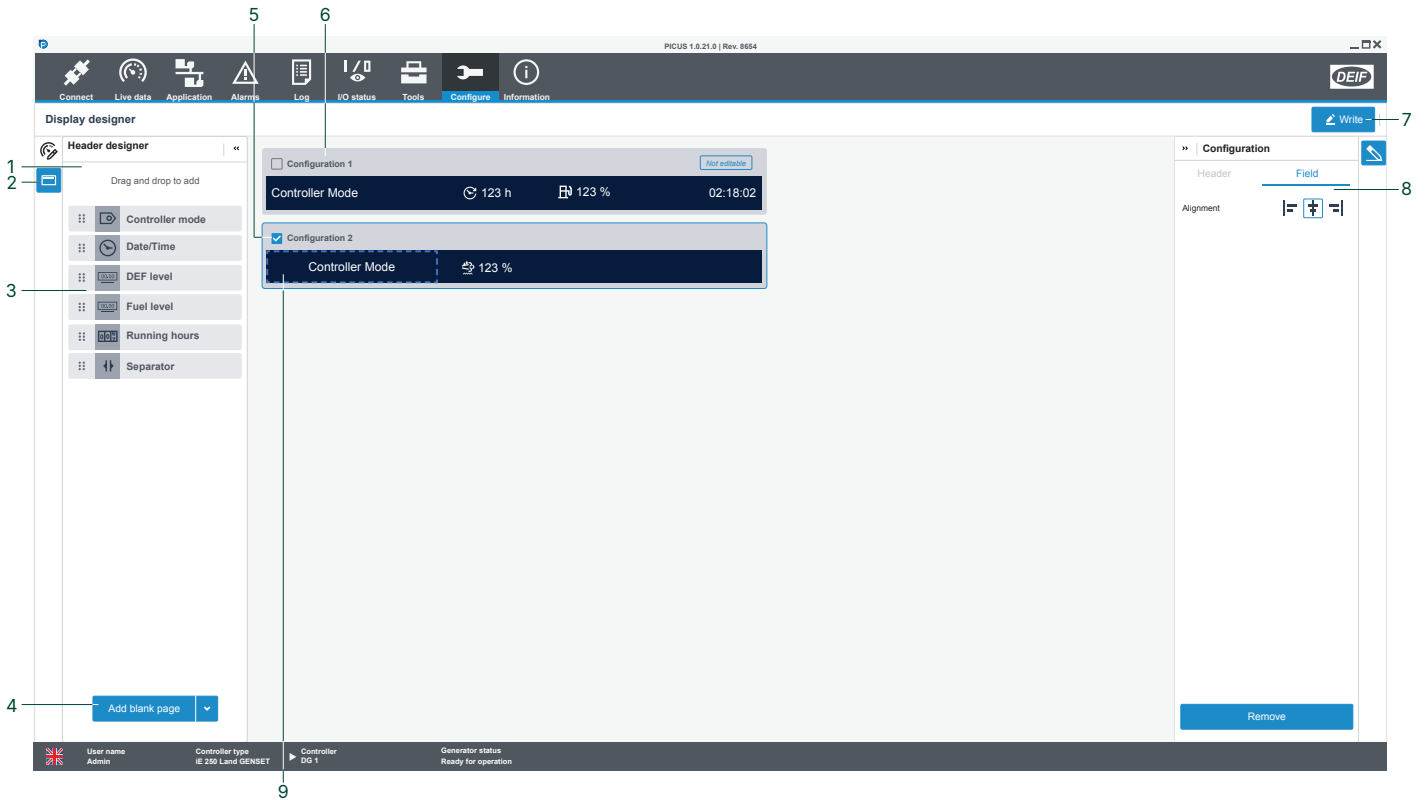

No.	Item	Notes
1	Dashboard designer	Configure the dashboard pages.
2	Header designer	Configure the header on the display.
3	Widgets	Drag and drop widgets to build your page.
4	Add page	Add either a blank page or use a page template.
5	Enable page	Enable the page on the display.
6	Page actions	See a preview of the page. Reorder the dashboard pages.
7		Write the configuration to the controller.
8	Configuration	Select a page or widget to configure it.
9	Dashboard pages	Select a page to configure. You can also enable or not enable a page from being shown.

10.3.3 Header designer



No.	Item	Notes
1	Dashboard designer	Configure the dashboard pages.
2	Header designer	Configure the header on the display.
3	Widgets	Drag and drop widgets to build your page.
4	Add header	Add a blank header.
5	Enable header	Enable the configuration as the active header.
6	Header configurations	Shows all the configurations available. Only one can be active.
7		Write the configuration to the controller.
8	Configuration	Select a page or widget to configure it.
9	Selected widget	Select a page to configure. You can also resize the widget on the header.

10.3.4 Indicator widget



Use the Indicator widget to give visual indications from a data source. This can be Commands, Parameters, I/O functions *, Priorities, signals from other controllers, regulator status, controller text status, or Counters.

NOTE To use the I/O function as a source you must first configure the function in the [Input/output configuration](#).

Simply drag and drop the Indicator widget to the page and configure the settings.

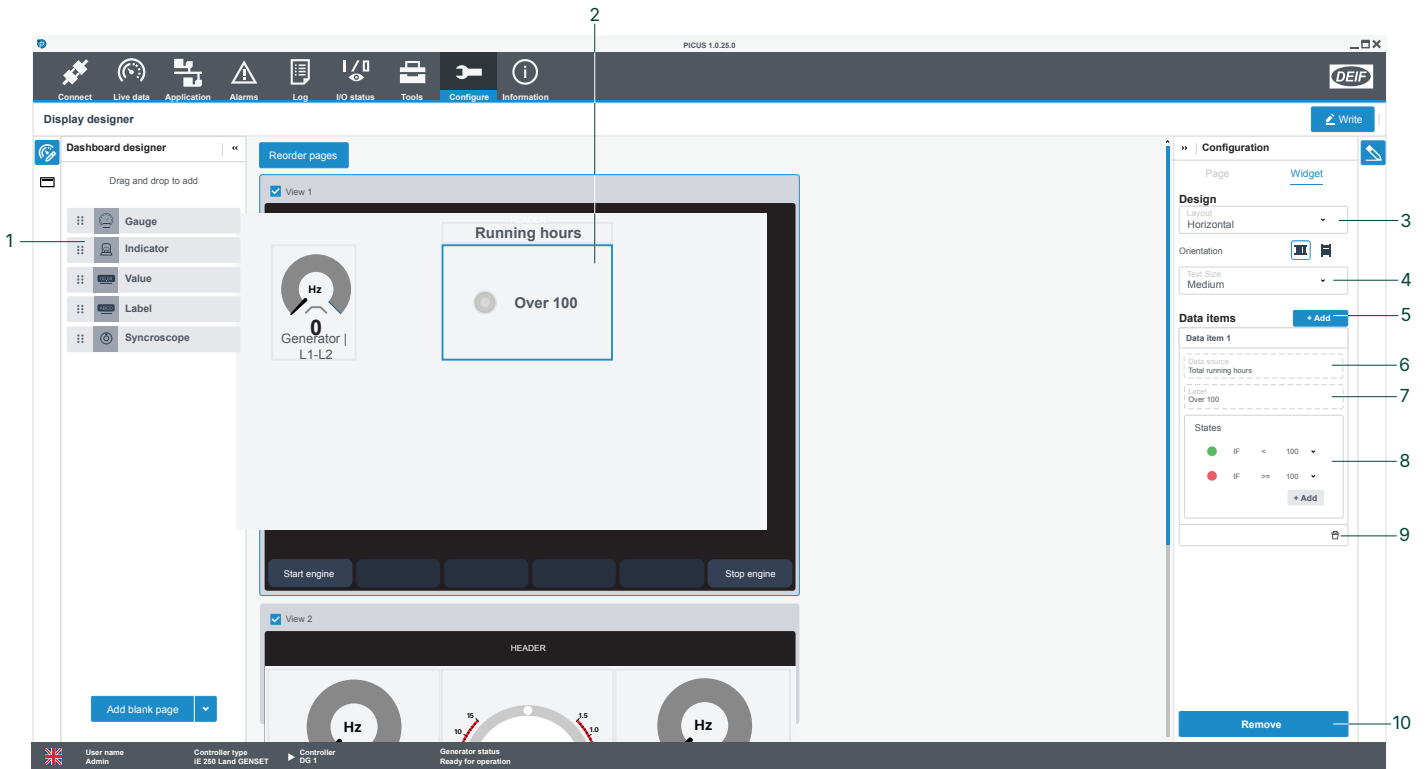

No.	Item	Notes
1	Indicator widget	Drag and drop widget to add to your page.
2	Indicator design	Shows how the indicator will be shown.
3	Layout	Configure if shown horizontal or vertical.
4	Text size	Configure the size of the text label.
5	Add data item	Adds additional data items.
6	Data source	Configure which data is used as the source.
7	Label	The label shown on the display.
8	Configuration	Assign the indication to specific data values.
9	Delete Data item	Delete the Data item, if there are several present.
10	Remove	Removes the Indicator widget from the page.

10.4 CustomLogic

10.4.1 About CustomLogic

CustomLogic can be used to create customised logical functions for your system. CustomLogic must be enabled under:

```
Local > CustomLogic > Configuration > Enable
```

Projects built with logic

CustomLogic is created from left to right on the logic grid. The logic between left and right vertical rails are called lines. A line can consist of a single input and output, or multiple inputs and outputs connected directly to each other, or connected with connectors.

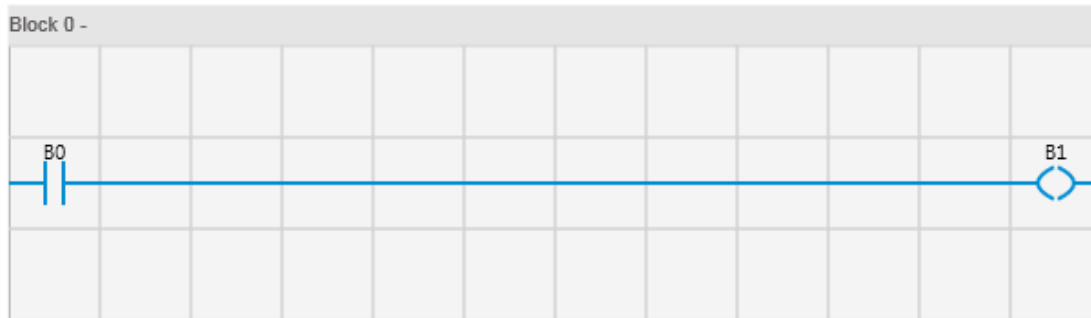

Logic can consist of several parallel lines.

A line is created of up to four element types:

- A contact (input)
- A function block (input)
- A connector
- A coil (output)

Lines are always read from the top of the block to the bottom of the block. Contacts (inputs) are always placed at the beginning of a line, and coils (outputs) always at the end. In some cases (for example, a counter block) the number of lines used as input does not match the amount of outputs.

When you build a line, it is not required to have an output. An example is a counter, since counter variables can be read directly by certain inputs and outputs.

Inputs and outputs for use in the logic

- Alarm state used as an input or used in the function COMPARE to check the actual state of the alarm.
- Controller function used as an input or set on an output.
- Digital inputs (DI) used as an input. *
- Digital outputs (DO) used as an input or set on an output. *
- Analogue inputs (AI) used in the function COMPARE to read measurement values. *
- Analogue outputs (AO) used in the functions COMPARE or OPERATE to read or change values. *
- Parameter value used in the functions COMPARE or OPERATE to read or change values.
- ICC (Inter-Controller Communication) used as an input or output. **
- Modbus used as an input.

NOTE * The input or output must be configured with a CustomLogic function before you can use it in your logic project.
** The controllers must be in the same single-line diagram, part of the same DEIF network, and have CustomLogic activated.

CustomLogic enabled state as an output (optional)

You can configure an output to use the CustomLogic state.

Function	IO	Type	Details
Local > CustomLogic > State > Is enabled	Digital output	Continuous	Activated when CustomLogic is enabled.

Variables

Variables can be used in CustomLogic instead of physical inputs and outputs to transfer the logic from one line to another. If you use variables, more of the controller's physical inputs and outputs are available for other functions. Variables are outputs that can be reused in more than one position or situation in the logic.

CustomLogic supports the use of Boolean variables. These are configured by setting the variable property to a pre-configured variable or a custom variable under:

```
Element setup > Functions
```

The value of the variable is equal to the output of the last coil in the project.

Custom variables are created by setting the variable property to "Bx" (where "x" is a number between 0 and 2147483647).

Project creation

Create your CustomLogic project in a three-step process:

1. Create a project with the required amount of sections and blocks.
2. Add the logic in the blocks with elements and functions.
3. Configure the elements and functions to represent the inputs, outputs, and variables.

10.4.2 CustomLogic constraints

- A CustomLogic project can only have one section.
- A section has a maximum of 50 blocks.
- Each block has a maximum of 96 elements.
- A project has a maximum of 600 elements.
- Logic lines **must** be connected left to right on the logic grid.

NOTE Counter, compare, operate, and timer blocks take up more than one space on the logic grid, but are considered as one element.

On PPU 300 or GPC 300 you cannot use CustomLogic if CODESYS is installed on the controller.

10.4.3 Project overview page

The screenshot displays the PICUS 1.0.21.0 software interface. The top navigation bar includes icons for Connect, Live data, Application, Alarms, Log, I/O status, Tools, Configure, and Information. The left sidebar is divided into several sections: Overview (with a 'Disabled (enable in parameters)' option), Logic Monitor, Design tools, Elements, Project (showing a tree view with 'Default Project', 'Section 0', and 'Block 0'), and Properties (with fields for Description and Name). The main workspace shows a ladder logic diagram for 'Block 0' with a 'Compare' function block and a 'B0' terminal. A vertical line with the number 10 points to the 'Compare' block in the diagram.

No.	Item	Notes
1	CustomLogic state	Shows CustomLogic parameter is Enabled or Not enabled .
2	Logic monitor	Changes to the Logic monitor page.
3	Design tools	Drag and drop tool elements .
4	Elements	Drag and drop function elements .
5	Project	Sections and blocks within the project.
6	Section or block	+ Add section or block. - Remove section or block.
7	Project actions	Open Project to load a previous project. New Project to create a blank project. Save project to your computer. Save as to create a new project on your computer.
8	Properties	Information about the selected project, section or block.
9	Actions	Read project from controller. Write project to controller.
10	Logic block	The ladder logic blocks.

10.4.4 Element setup page

The screenshot displays the 'Element setup' page in the DEIF PICUS 1.0.21.0 software. The interface is divided into several sections:

- 1**: Description of the selected element, showing a normally open contact symbol and a text description: "Normally open contact. The output of the normally open contact is the same as the activation state of the function assigned to it. For".
- 2**: Internal variables section, listing variables B0- and B1-.
- 3**: Functions section, showing a tree view with 'Alarms', 'Functions', and 'Engine' (with sub-items like 'Start engine', 'Stop engine', etc.).
- 4**: Description and variable field, with a text input for 'Description' and a dropdown for 'Variable' set to 'B0'.
- 5**: Save button, represented by a floppy disk icon.
- 6**: Actions section, with 'Read' and 'Write' buttons.
- 7**: Logic block workspace, showing a ladder logic diagram for 'Block 0' with a 'Compare' block and a variable 'B0'.

The bottom status bar shows: User name: Admin; Controller type: PPM 300 DG; Controller: [arrow]; Generator status: Switchboard control.

No.	Item	Notes
1	Description	Information about the selected element.
2	Internal variables	List of all the internal variables in the project.
3	Functions	Associated function to the element. Double click on a function to add it to the variable field of the selected element.
4	Description and variable	Information for the element and the associated variable.
5	Save element information	Save element description and variable.
6	Actions	Read project from controller. Write project to controller.
7	Logic block	Shows the ladder logic block.



10.4.5 Monitor page

No.	Item	Notes
1	CustomLogic state	Shows CustomLogic parameter is Enabled or Not enabled .
2	Logic creator	Change to the Logic creation .
3	Element state	Shows state of configured elements: <input type="checkbox"/> FALSE <input checked="" type="checkbox"/> TRUE
4	Actions	Read project from controller. Write project to controller.
5	Logic block *	Shows the logic block and state: TRUE FALSE

NOTE * When CustomLogic is enabled, the logic monitor shows the state of the logic being processed in the controller. If CustomLogic is not enabled, the grid is faded and displays the state of the logic when CustomLogic was last enabled. The logic block has a refresh rate of 500 milliseconds.

10.4.6 Elements and functions

Connectors





Symbol	Name	Description
	Horizontal connector	A normal connector used to complete lines.
	Vertical connector	A connector used to connect parallel lines. This allows for parallel functions or multiple inputs. The connector is created in the upper left corner of the position where it is placed. The vertical connector can be placed over other elements if required. For example, it can be placed over a coil to create parallel outputs. If the element under the vertical connector is moved, the vertical connector is deleted.
	Long horizontal connector	Connects the position where the connector is placed horizontally with the next element to the right of the position or the end of the line.

Miscellaneous elements

Symbol	Name	Description
	Eraser	The eraser element can be dragged onto an existing element in the ladder diagram to delete that element from the ladder.

Contacts

Contacts (inputs) are normally on the left vertical rail. Contacts could be placed anywhere on the logic grid, except for the right-most position.

Symbol	Name	Description	Output for TRUE input
	Normally open contact	The output of the normally open contact is the same as the activation status.	TRUE
	Normally closed contact	The output of the normally closed contact is the opposite of the activation status.	FALSE
	Rising edge contact	The output of the rising edge contact is the same as the activation status for one scan of the contact. After the contact is scanned, the output changes to FALSE until it is activated again.	TRUE (one scan)
	Falling edge contact	The output of the falling edge contact is the opposite of the activation status for one scan of the contact. After the contact is scanned, the output changes to TRUE until it is activated again.	FALSE (one scan)

Coils

Coils (outputs) are always next to the right vertical rail. One exception is the Operate function block which also acts as an output.

Symbol	Name	Description	Output for TRUE input
	Normally open coil	The output of the normally open coil is the same as the input.	TRUE
	Normally closed coil	The output of the normally closed coil is the opposite of the input.	FALSE
	Set coil	The output of the set coil changes to TRUE when the input is TRUE. The output remains TRUE until a reset coil is activated (even if the input is no longer TRUE).	TRUE (continuously)
	Reset coil	The output of the reset coil changes to FALSE when the input is TRUE. The output remains FALSE until a reset coil is activated (even if the input is no longer TRUE).	FALSE (continuously)
	Jump coil	This type of coil jumps to another block in the ladder logic. The remainder of the vertically scanned rung block, in which the jump coil appears and all the rung blocks up until the destination rung block, are not executed.	TRUE
	Operate block *	This block is an internal output instruction in the ladder logic and can be used to assign a value to a variable. Parameter values that are set with the Operate function MUST be within the accepted parameter range. See the accepted range for each parameter under <code>Configure > Parameters</code> .	TRUE

NOTE * All variables used in the OPERATE block must have the same unit of measure.

Functions

Symbol	Name	Description
	Timer block	When the input to a timer block goes to TRUE, the timer starts to count from zero to a pre-configured value. There are three different timer modes: 1. Timer on (TON) 2. Timer off (TOF) 3. Timer pulse (TP). See Function blocks for more information.
	Counter block	The counter block functions as a counter between 0 and 9999, and can store one preset value. A counter block consists of four inputs which operate the counter and three outputs which give the current status of the counter. See Function blocks for more information.
	Compare block	The compare element can be used to compare variables and/or expressions with each other. If the expression is true, the output of the compare block is also true. These comparisons can be used: <ul style="list-style-type: none"> > "greater than" >= "greater than or equal to" < "less than" <= "less than or equal to" <> "different to" = "equal to" See Function blocks for more information.

10.4.7 Function blocks

Timer block properties

Properties	Range	Default	Description
ID		TM0	The name of the timer. When specifying timer variables, the variable is preceded by the timer ID.
Mode	TON, TOF, TP	TON	<p>When TON is selected: After the timer reaches the preset value, the timer output changes from FALSE to TRUE.</p> <p>When TOF is selected: After the timer reaches the preset value, the timer output changes from TRUE to FALSE.</p> <p>When TP is selected: After the timer reaches the preset value, the timer output will change from TRUE to FALSE. The timer starts counting when the input is TRUE (pulse or constant), and continues to count until it reaches the preset value.</p>
Preset	0 to 9999	0	The preset value where the timer stops and the output is changed.
Unit	Minutes, seconds, 100 milliseconds	Minutes	<p>The unit of time used for the count.</p> <p>If the timer is set to 200 ms or less, it will run out after one scan due to the CustomLogic scanning frequency.</p>

After changing the *ID* or the *Preset* properties, select **Save**  to apply the new value to the element.

Timer block variables

Variables	Range	Description
TMxx.Q *	TRUE, FALSE	The variable value is the same as the timer output.

NOTE * **TMxx** should be substituted by the timer ID when referring to the variable.

Counter properties

Properties	Range	Default	Description
ID		C0	The name of the counter. When specifying counter variables, the variable is preceded by the timer ID.
Preset	0 to 9999	0	The preset value is a target value to which the counter counts.

After changing the *ID* or the *Preset* properties, select **Save**  to apply the new value to the element.

Counter inputs and outputs

Properties	Type	Description
R	Input	When this input is TRUE, the count is reset to 0.
P	Input	When this input is TRUE, the count is set to the preset value.
U	Input	When this input is TRUE, the count is increased by one.
D	Input	When this input is TRUE, the count is decreased by one.
E	Output	This output registers count under flow. The output will change from FALSE to TRUE when the counter rolls back from 0 to 9999.

Properties	Type	Description
D	Output	This output (<i>Done</i>) registers when the count has reached the preset value. When the count does not equal the preset value, the output is FALSE. When the count is equal to the preset value, the output is TRUE.
F	Output	This output registers count over flow. The output will change from FALSE to TRUE when the counter rolls over from 9999 to 0.

Counter variables

Variables	Range	Description
Cxx.D *	TRUE, FALSE	TRUE if the count equals the preset value. FALSE otherwise.
Cxx.E *	TRUE, FALSE	TRUE if the count changed from 0 to 9999. FALSE otherwise.
Cxx.F *	TRUE, FALSE	TRUE if the count changed from 9999 to 0. FALSE otherwise.

NOTE * Cxx should be substituted by the counter ID when referring to the variable.

Compare

The compare function block sets the output depending on the logical expression in the block.

When the input is FALSE, the output will always be FALSE.

When the input is TRUE, the block will check if the logical expression is true. If the logical expression is true, then the output is TRUE. If the logical expression is false, the output remains FALSE.

Compare logical operators

Operator	Output
$X > Y$	TRUE if X is greater than Y
$X \geq Y$	TRUE if X is greater than or equal to Y
$X < Y$	TRUE if X is less than Y
$X \leq Y$	TRUE if X is less than or equal to Y
$X \neq Y$	TRUE if X is different from Y
$X = Y$	TRUE if X is equal to Y

10.4.8 Configure a CustomLogic project

Create a project

- Select  **New**
 - If you create a new project it clears the logic shown, but the previous project remains on the controller until the new project is written to the controller.
- Select the project and configure the properties:

Properties	
Author	DEIF A/S
Target	ML300
Version	1.1
Name	New project

3. Select **+** **Add** to add a section.

4. Select the section and configure the properties:

Properties	
Description	Main logic
Type	Main
Name	Section 0

5. Select **+** **Add** to add a block to the section.

6. Select the block and configure the properties:

Properties	
Description	First logic set
Name	Block 0

7. Add additional sections and blocks as required.

8. Select **Write** to save the project to the controller.

Add elements or functions

1. Drag and drop elements from the elements to a location on the logic grid:

- Contacts and all function blocks can be placed in columns 1 to 11 of the logic grid:



- Coils can only be placed in column 12.



2. Add and connect elements on the logic grid by drag-and-drop from the Design tools menu.

- Elements can be moved around on the grid. It is not possible to move an element from one block to another block.

3. All elements on the logic grid must have a connection to the left vertical rail.

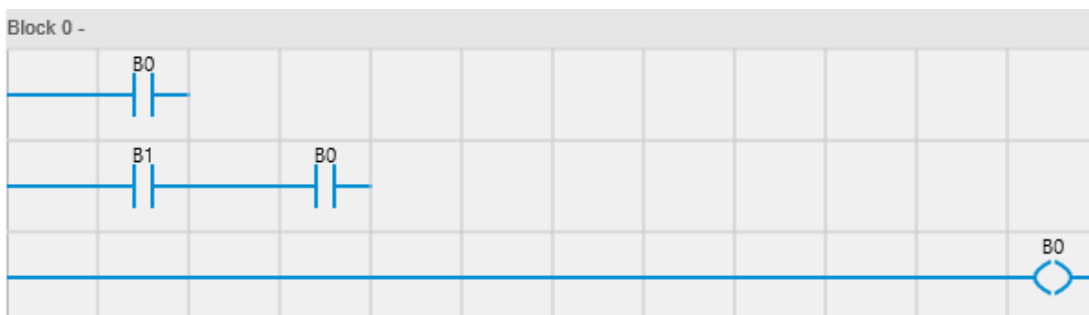



4. Select  **Write** to save the project to the controller.

Configure element or function

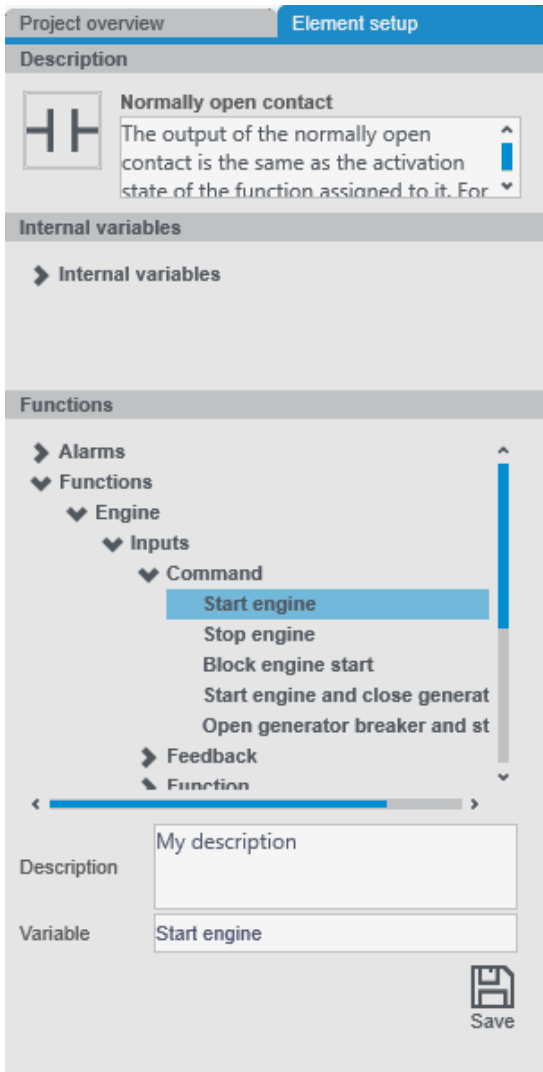
1. Select an element on the logic grid.
2. Select Element setup.
3. Configure the properties:



4. Select  **Save** to update the configuration.
5. Select  **Write** to save the project to the controller.

10.4.9 Logic gate examples

All outputs use a normally open coil, the output of which reflects the input. Element names are a letter and a number, for example "B1".

AND example

Two normally open contacts connected in series. For the output of a normally open coil to be TRUE, the inputs of both normally open contacts must be TRUE. This logic can be extended to be used with more than two normally open contacts connected in series.

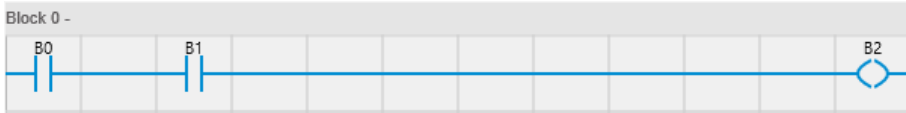

B0	B1	B2
FALSE	FALSE	FALSE
FALSE	TRUE	FALSE
TRUE	FALSE	FALSE
TRUE	TRUE	TRUE

OR example

Two normally open contacts connected in parallel. For the output of the normally open coil to be TRUE, one, or both of the normally open inputs must be TRUE. This logic can be extended to be used with more than two normally open contacts connected in parallel.

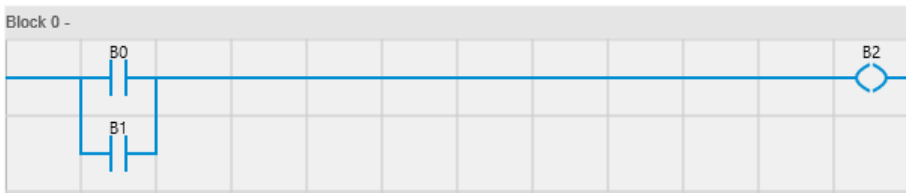

B0	B1	B2
FALSE	FALSE	FALSE
FALSE	TRUE	TRUE
TRUE	FALSE	TRUE
TRUE	TRUE	TRUE

NOT example

One normally closed contact. The output of a normally open coil will always be the opposite of the input of the contact.

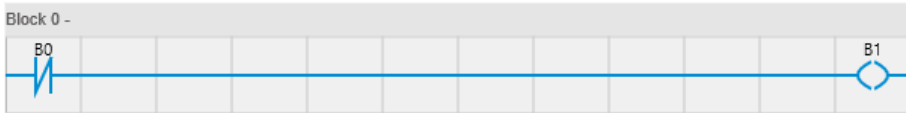

B0	B1
FALSE	TRUE
TRUE	FALSE

NAND example

Two normally closed contacts connected in parallel. This operation is the opposite of the AND operation. The output of a normally open coil is TRUE, until the input of both normally closed contacts is TRUE. This logic can be extended to be used with more than two normally closed contacts in parallel.

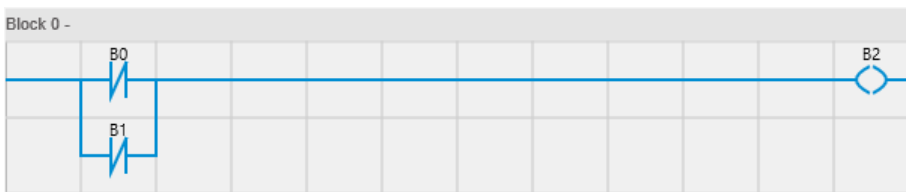

B0	B1	B2
FALSE	FALSE	TRUE
FALSE	TRUE	TRUE
TRUE	FALSE	TRUE
TRUE	TRUE	FALSE

NOR example

Two normally closed contacts connected in series. This operation is the opposite of the OR operation. The output of a normally open coil is TRUE, until the input of one or both normally closed contacts is TRUE.

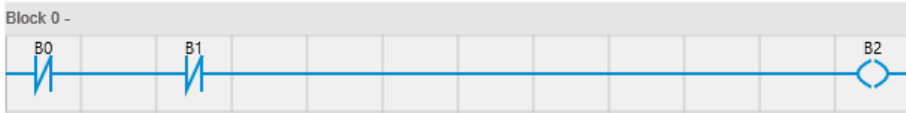

B0	B1	B2
FALSE	FALSE	TRUE
FALSE	TRUE	FALSE
TRUE	FALSE	FALSE
TRUE	TRUE	FALSE

XOR example

A normally open contact and normally closed contact connected in series, connected in parallel to a normally closed contact and normally open contact that are connected in series. For the output of the normally open coil to be TRUE, either B0 or B1 must be TRUE, but not at the same time.

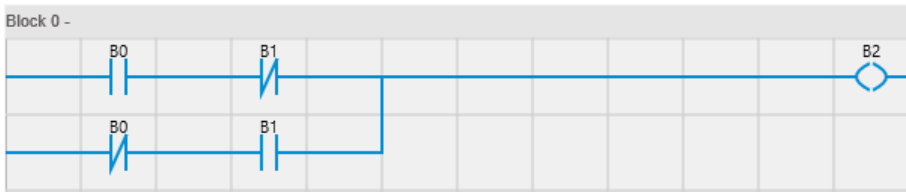



B0	B1	B2
FALSE	FALSE	FALSE
FALSE	TRUE	TRUE
TRUE	FALSE	TRUE
TRUE	TRUE	FALSE

10.5 Modbus

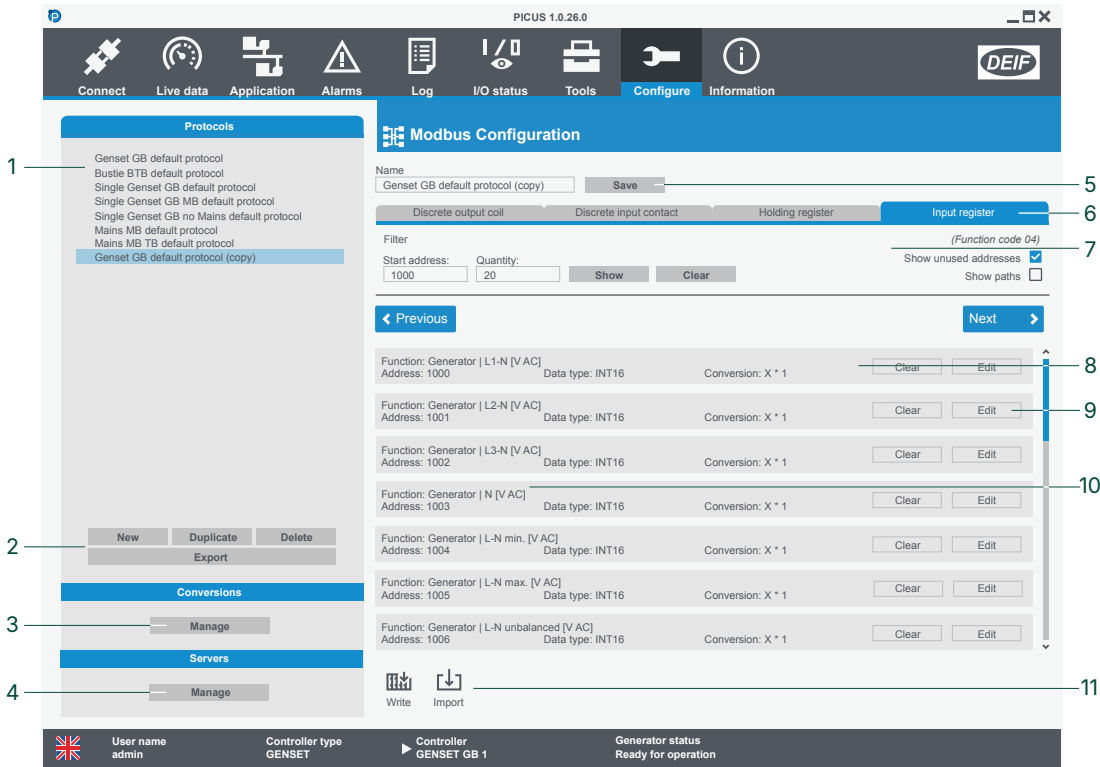
10.5.1 Protocols page



No.	Item	Notes
1	Protocol list	Shows the protocols on the controller.
2	Commands	New protocol.
		Duplicate the selected protocol.
3	Conversions page	Delete the selected protocol.
		Export the protocol.
4	Servers page	Change to the Modbus servers page.
5	Protocol name	Name of Modbus protocol.
6	Supported Modbus functions	Discrete output coil : Read and write addresses in binary data.
		Discrete input contact : Read only addresses in binary data.
7	Address filter	Holding register : Read and write addresses in boolean, 16 and 32-bit integer, float or bit map data.
		Input register : Read only addresses in boolean, 16 and 32 bit integer, float or bit map data.
8	Modbus address details	Unused address : A function can be assigned if a duplicated protocol.
		Reserved address : Function assigned is not configurable. The function cannot be restored if it is cleared.
		Function : Controller path of the function assigned.
9	Address configuration commands (Default protocols cannot be edited)	Address : Modbus address of the function.
		Conversion : Scaling or conversion associated. *
9	Address configuration commands (Default protocols cannot be edited)	Set : function to an unused address.
		Edit : function assigned to the selected address.
9	Address configuration commands (Default protocols cannot be edited)	Clear : function assigned to the selected address.

No.	Item	Notes
10	Function path	Full function path displayed by default.
		Collapse: the function name. ...: expand the function path.
11	Modbus function commands	 Write changes to the selected function to the controller.  Import a Modbus function to replace the selected function.

NOTE * Only available in the Holding and Input registers. Scaling is not available for binary values.

10.5.2 Create, edit, or export a protocol

The controller default protocol cannot be edited or removed.

Create a new protocol

1. Select **New**.
2. Enter a name:

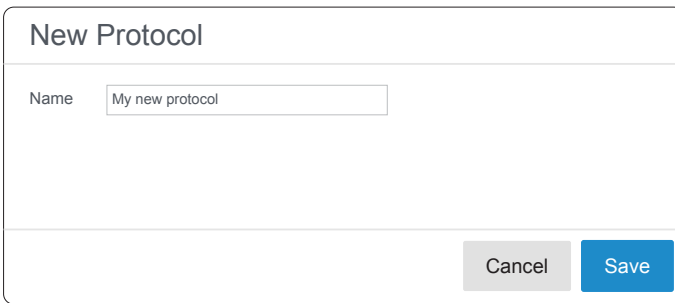

3. Select **Save**.
4. Select the new protocol to access the Modbus functions.
5. Select a Modbus function to configure.
6. Configure Modbus addresses individually with the filter and **Set** address configuration command, or import an existing Modbus function.

Duplicate an existing protocol

1. Select a Modbus protocol to duplicate.
2. Select **Duplicate**.
3. Enter a name:

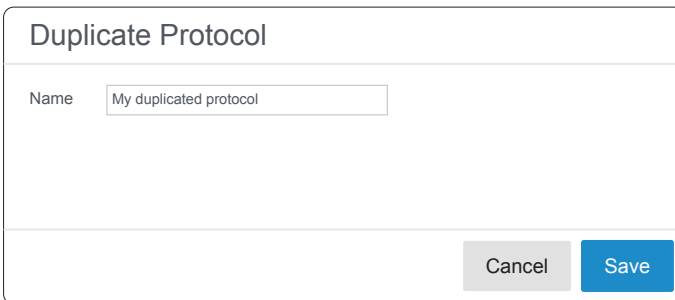

4. Select **Save**.
5. Select the new protocol to access the Modbus functions.
6. Select a Modbus function to configure.
7. Configure Modbus addresses individually with the filter and **Set** address configuration command, or import an existing Modbus function.

Edit a protocol

Edit a used address

1. Select the protocol to configure from the protocol list.

2. Select the Modbus function to configure.
3. Use the filter to select the address range to configure.
 - Type in the start address and the number of addresses (including the Start address) to read from the controller.
 - If Show Unused Addresses is **not enabled**, then only configured addresses are shown.
 - The amount of addresses shown can be less then the value entered in Quantity.
4. Select **Edit** to configure the selected address.
5. Select  **Write** to write the changes to the controller.

Clear a used address

1. Select the protocol to configure from the protocol list.
2. Select the Modbus function to configure.
3. Use the filter to select the address range to configure.
 - Type in the start address and the number of addresses (including the Start address) to read from the controller.
 - If Show Unused Addresses is **not enabled**, then only configured addresses are shown.
 - The amount of addresses shown can be less then the value entered in Quantity.
4. Select **Clear** to remove the function associated to the address.
5. Select  **Write** to write the changes to the controller.

Set a function to an unused address

1. Select the protocol to configure from the protocol list.
2. Select the Modbus function to configure.
3. Use the filter to select the address range to configure.
 - Type in the start address and the number of addresses (including the Start address) to read from the controller.
 - Show Unused Addresses must be **enabled** to see empty addresses.
4. Select **Set** to open the Function Editor.
5. Select the function to associate to the Modbus address:

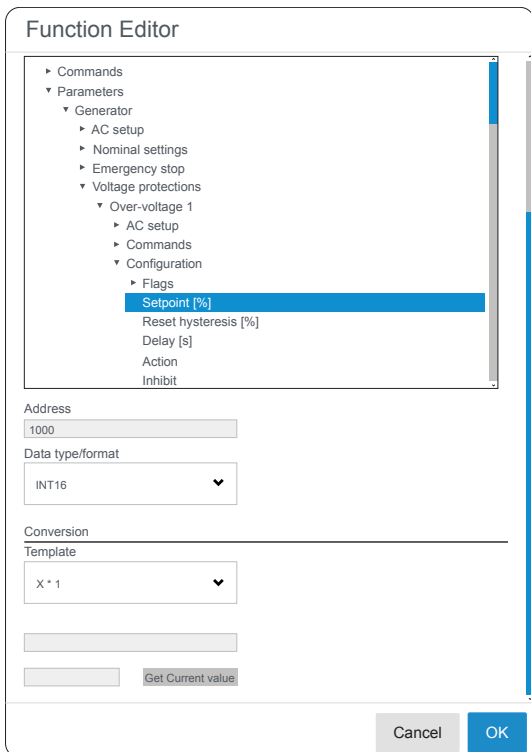

- Functions that don't match the Data type/format for the address cannot be selected.
- The Data type/format can be selected for register addresses.
- A conversion formula must be selected for register addresses.
- Test the selected conversion with **Get Current value**.

6. Select **OK**.
7. Select  **Write** to write the changes to the controller.

Import a protocol

If you import a function it overwrites existing data without a warning notification.

1. Select the protocol to import.
 - The controller only accepts Modbus functions that use the correct xml-format.
 - Only custom protocols or copies of default protocols can be imported.
2. Select the Modbus function to import data to.
3. Select  **Import**.
4. Select the file to import and select **Open**.
5. Select **Dismiss** to close the confirmation window when the import is complete.

Export a protocol

Exported protocols are saved as four xml files (one for each function).

1. Select the protocol to export from the protocol list.
2. Select **Export** to open the location selection window.
3. Select a location to store the Modbus functions.
4. Select **Select folder**.
5. The protocol is exported to the folder you selected.
 - Example: *

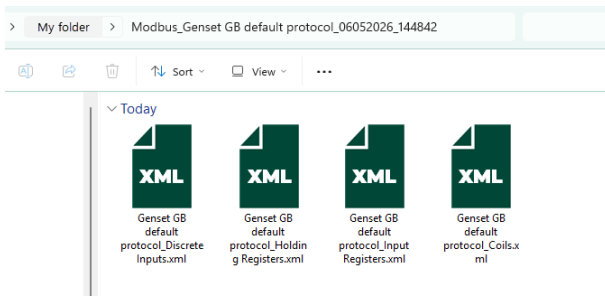

NOTE * The XML files are named for your product, the above example is for iE 250.

10.5.3 Conversions page

The screenshot displays the 'Modbus Configuration' interface. On the left, a 'Conversions' list contains various scaling and unit conversion options. The main area shows the configuration for 'New conversion 1', including a formula field set to '10*x', a reverse formula dropdown set to 'New conversion 1', and a test conversion input of '2' which outputs '= 100'. A table of allowed characters and their descriptions is provided below the configuration form. The bottom status bar indicates the user is 'Admin', the controller is 'PPM 300 DG', and the generator status is 'Switchboard control'.

No.	Item	Notes
1	Protocol page	Change to the Modbus protocols page.
2	Conversions list *	Shows the conversions (scaling and unit) on the controller.
3	Commands	New conversion.
		Delete the selected conversion.
4	Servers page	Change to the Modbus servers page.
5	Conversion label	Name of a custom conversion.
6	Formula **	The conversion formula applied when you read a Modbus address.
7	Reverse formula	Conversion formula applied when you write a value to a Modbus address. The Reverse formula is always selected from the existing conversions.
8	Conversion test	Select a value for x to test the result of the Formula.
9	Modbus function commands	Write the conversion to the controller.

NOTE * The controller default conversions cannot be edited or removed.

** The Formula is a function of x, where x represents the raw value of the Modbus address.

10.5.4 Create or edit a conversion

Create a new conversion

Allowed characters	Description
X x	Input variable
0123456789	Digital numbers used for fixed and floating values.
.	Dot, used for floating values, E.g. '1.5' or '0.5'
+ -	Addition and subtraction, E.g. 'x + 5' or 'x - 3' Can also be used as sign, E.g. '-1 + x' or 'x - +4'
* /	Multiply and division, E.g. 'x * 2 + 10' or 'x / 5 - 3'
^	Power of, E.g. 'x^2' or 'x^(-1 + x * 5 + 3)'
()	Parenthes brackets, E.g. 'x^2 * (x - 4)' or '((x+3) * 4) ^2'
E e	Exponent, E.g. '1E3' = 1000 or '2E-3' = 0.002

1. Select **New**.
2. Enter a name for the conversion.
3. Type the formula for the conversion as a function of x .
 - The Formula is the conversion used when you read the data.
 - "x" is the value read by the controller for the function assigned to the address.
4. Select the Reverse formula from the list of existing formulae.
 - The Reverse formula is the conversion used when you write the data.
 - If the Reverse formula is not available, then a new conversion must be created where the Formula contains the desired Reverse formula.
5. Optional: Type a number in the Test conversion field and select **Test conversion** to see an example of the result of your new conversion (Formula).
6. Select **Write** to write the changes to the controller.

If there is an error with the Formula or Reverse formula, then the conversion defaults to $x*1$ for both the Formula and Reverse formula.

Duplicate a conversion

1. Select the conversion to duplicate and select **Duplicate**.
2. Optional: Enter a new name.
3. Select **Write** to write the changes to the controller.

Edit a conversion

1. Select the conversion to edit.
 - Default conversions cannot be edited.
2. Make the desired changes.
3. Select **Write** to write the changes to the controller.

10.5.5 Servers page

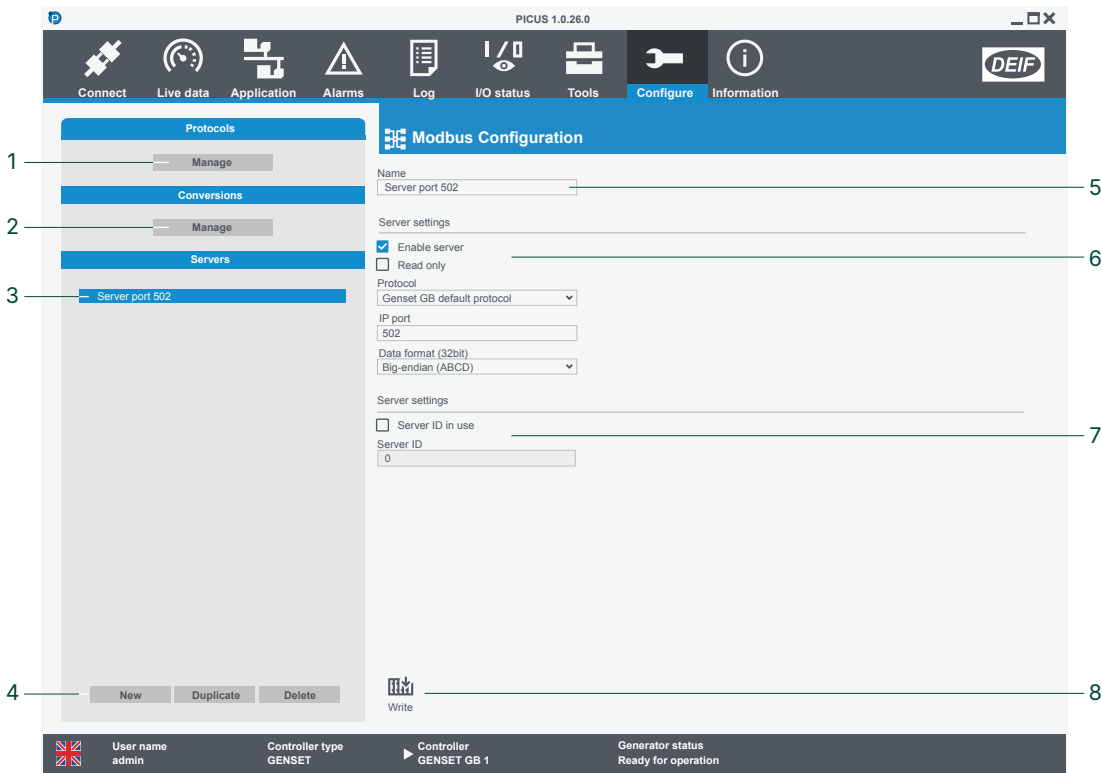

No.	Item	Notes
1	Protocol page	Change to the Modbus protocols page.
2	Conversions page	Change to the Modbus conversions page.
3	Server list	Shows the servers on the controller.
4	Commands	New server.
		Delete the selected server.
5	Server name	Name of selected server.
6	Server settings	Enable server: Enable the selected server as active on the controller.
		Protocol: Select the Modbus protocol that is associated with the server.
		Data format (32bit): Byte order of the data sent with Modbus.
7	Server settings	Read only: Enable all of the Modbus addresses as read only addresses and function codes 05, 06, 15 and 16 do not respond.
		IP port: The communication port for the server. *
7	Server settings	Server ID in use: Enabled the server uses the specified Server ID. If multiple servers are enabled and use the same IP port, then this parameter must be enabled.
		Server ID: The unique Server ID associated with the Modbus server. If Server ID in use is not enabled, then the Server ID is 0.
9	Server commands	 Write the server to the controller.

NOTE * The default Modbus port is port 502. If multiple servers are active and use the same port, then each server must have a unique Server ID.

10.5.6 Create or edit a server

Create a new server

1. Select **New**.
2. Enter a name for the server.
3. Configure the Server settings section:
 - **Enable server**: Activate or deactivate the server.
 - **Read only**: If **Enabled** then all of the Modbus addresses are read-only addresses.
 - **Protocol**: The Modbus protocol used on the server. Select from a list of existing protocols.
 - **IP port**: The communication port for Modbus communication. If more than one active server uses the same IP port, a Slave ID must be configured for all servers.
 - **Data format (32bit)**: Select the data format for 32-bit addresses (32-bit integer, float).
4. Optional: Configure the Slave settings section.
 - **Slave ID in use**: Only **Enable** this if you have multiple enabled servers that use the same communication port.
 - **Slave ID**: Select the ID number for the slave unit. ID number must be unique for every server that use the same communication port.
5. Select  **Write** to write the changes to the controller.

Duplicate a server

1. Select the server to duplicate.
2. Select **Duplicate**.
3. Optional: Enter a new name.
4. Select  **Write** to write the changes to the controller.

Edit a server

1. Select the server to edit.
2. Configure the settings.
3. Select  **Write** to write the changes to the controller.

10.6 Counters

10.6.1 About Counters

Specific events are recorded as counters. You can view or reset the counters recorded on the Counters page. The actual recorded counters can vary by product.

Examples include:

- Application counters
- Start attempts
- Total running hours and minutes
- Trip running hours and minutes
- Generator breaker operations and trips
- Energy export (active and reactive)
- Custom counters from CODESYS



More information

See **Counters** in the **Designer's handbook** for information about the counters available under each controller type.

10.6.2 Counters page

The screenshot shows the 'Counters' page in the PICUS 1.0.21.0 software. The interface is organized into several sections:

- Start attempts:** A table with columns 'Name', 'Value', and 'Pre-set value'. Rows include 'Total' (0), 'Since reset' (0), and 'Faults' (0).
- Operation time:** A table with columns 'Name', 'Value', and 'Pre-set value'. Rows include 'Total running hours' (0 h), 'Total running minutes' (0 min), 'Running hours since reset' (0 h), and 'Running minutes since reset' (0 min).
- Production counters:** A table with columns 'Name', 'Value', and 'Pre-set value'. Rows include 'Active energy export' (0 kWh) and 'Reactive energy export' (0 kvarh).
- Generator breaker:** A table with columns 'Name', 'Value', and 'Pre-set value'. Rows include 'Close operations' (0), 'Close operations since reset' (0), 'Failed operations' (0), and 'Trips' (0).

Numbered callouts (1-10) indicate specific UI elements: 1 (Filter menu), 2 (Filter list), 3 (Write button), 4 (More options icon), 5 (Expand/Collapse all icons), 6 (Write button for a counter), 7 (Expand/Collapse icon for a group), 8 (Pre-set value input field), 9 (Write button for a pre-set value), and 10 (Reset icon for a pre-set value).

No.	Item	Notes
1	Collapse/expand menu	Open/close the Filter menu.
2	Filter select	Select all counters or a specific group of counters.
3	Write	Write all values to the controller.
4	More options	Show or hide paths for the counters.
5	Expand all/Collapse all	Expand all : Expands all items in the list. Collapse all : Collapses all items in the list.
6	Write	Write values for the current group to the controller.
7	Expand/collapse	Expand or collapse the group menu.
8	Value	Change a pre-set value for the counter.
9	Write	Write the new value to the controller.
10	Reset	Reset the value.

10.7 Fieldbus configuration

10.7.1 About Fieldbus

Use Fieldbus to supervise or configure Fieldbus connections to the controller. The hardware modules in the controller, extension racks, and ECU are handled as Fieldbus connections.

 [Fieldbus configuration](#) Allows you to prepare the controller for hardware changes and confirm changes made.

 [Fieldbus supervision](#) Allows you to troubleshoot the conflicts in the controller.

10.7.2 Fieldbus configuration page

The screenshot shows the DEIF PICUS 1.0.25.0 Fieldbus configuration page. The interface includes a top navigation bar with icons for Connect, Live data, Application, Alarms, Log, I/O status, Tools, Configure, and Information. The main content area is divided into several sections:



- 1:** Fieldbus configuration sidebar, including 'Drag I/O extension unit to fieldbus' (listing DEIF Extension units, DEIF 7-slot rack, DEIF 4-slot rack), 'Controller Information', 'Configuration', 'CAN C', and 'Actions'.
- 2:** Controller Information section showing details like Controller label (SINGLE 1), ID (1), IPv4 (11.10.102.107), IPv6 (fe80::226:77ff:fe01:bd0), and Racks (3 of 11).
- 3:** Configuration section for the selected rack (IE 250), including Rack type (DEIF IE 250) and Topology (Single connection).
- 4:** CAN C configuration section, including EIC (Generic J1939), Source address (0), DAVR (DEIF DVC 550), and Source address (144).
- 5:** Actions section with icons for Modules, Scan fieldbus, and Write.
- 6:** Controller information section showing details for the selected controller (SINGLE 1).
- 7:** Selected fieldbus element (DEIF 7-slot rack).
- 8:** Delete icon for the selected extension rack.
- 9:** Fieldbus diagram showing the configuration of the extension unit and rack.

The bottom status bar displays: User name (Admin), Controller type (Land SINGLE_GENSET), Controller (SINGLE 1), and Generator status (Not ready for operation).

No.	Item	Notes
1	Fieldbus elements	Drag and drop elements to the diagram.
2	Controller information	Shows the communication information of the controller, the number of extension units used and the information of the selected extension unit.
3	Rack and topology configuration	Configuration information for the rack and topology.
4	CAN bus configuration	Configure CAN protocol and source address for: <ul style="list-style-type: none"> EIC (ECU) DAVR (if supported)
5	Actions	Modules to configure the modules in the selected rack. Scan fieldbus to scan the configuration. Write changes to controller.
6	Controller	Summary information for the connected and logged on controller.
7	Selected fieldbus element	The rack that the Modules action and information are linked to.
8	Delete	Delete the extension rack.
9	Fieldbus diagram	Shows the Fieldbus configuration. *



NOTE * When an ECU or DAVR is configured these are not shown on the diagram.

10.7.3 Detect setup

1. Select  **Scan fieldbus**.
2. Select **Confirm**.
3. Select  **Write** to write the changes to the controller.

10.7.4 Add extension racks

Automatically add extension racks

1. Select  **Scan fieldbus**.
2. Select **Confirm**.
3. Select  **Write** to write the changes to the controller.

Manually add extension racks

1. Drag and drop the required extension rack to the fieldbus diagram.

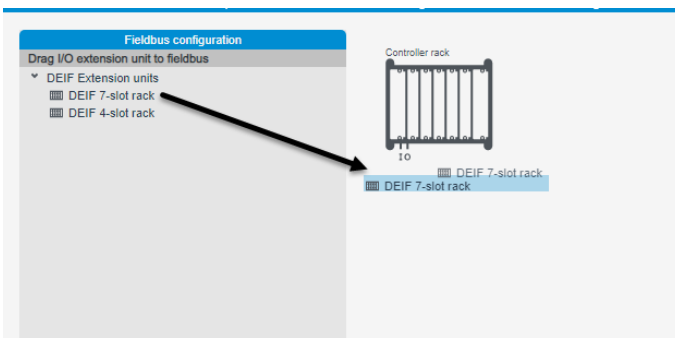

2. Select the new rack.
3. Select  **Modules**.
4. Select the modules in the rack from the selection box:

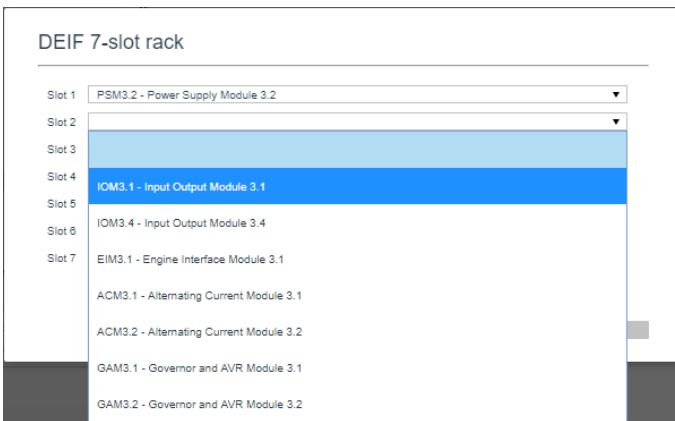

5. Select **Accept**.
6. Optional: Enter the Label with a unique name for the new rack.
7. Select  **Write** to write the changes to the controller.

10.7.5 Add an ECU

1. Select the controller to configure.
2. Select the CAN protocol from the selection list.
3. Change the source address if needed, the default is address **0**.
4. Select  **Write** to write the changes to the controller.

The controller can now connect to the ECU for control, reading information, assigning functions in input/output, I/O status, Live data, alarms, and logs.



More information

See the **Engine interface communication** manual for information about the supported engines and protocols.

10.7.6 Add a DVAR

1. Select the controller to configure.
2. Select the DAVR from the selection list.
3. Change the source address if needed.
4. Select  **Write** to write the changes to the controller.

10.7.7 Configure fieldbus

Change connection topology

1. Select the topology from the selection.
 - **Redundancy connection**
 - A network ring connection between the controller and extension racks.
 - The last rack in a network chain is connected back to the controller.
 - **Single connection**
 - A network chain connection between the controller and extension racks.
 - A single connection from one rack to the next.
2. Select  **Write** to write the changes to the controller.

Change modules

1. Select the rack to configure.
2. Select  **Modules**.
3. Select the modules in the rack from the selection box:

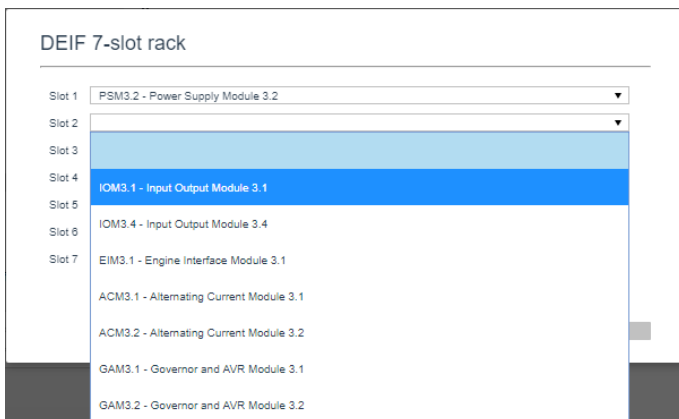

4. Select  **Write** to write the changes to the controller.

Change rack name

1. Select the rack to configure.
2. Select the Label field and enter the new name for the rack.
 - The default name for the rack is written in grey text if the rack does not have a custom name.
3. Select  **Write** to write the changes to the controller.

Change rack type

1. Select the rack to configure.
2. Select the Rack type from the selection.
3. Select  **Write** to write the changes to the controller.

10.8 Fieldbus supervision

10.8.1 Fieldbus supervision page

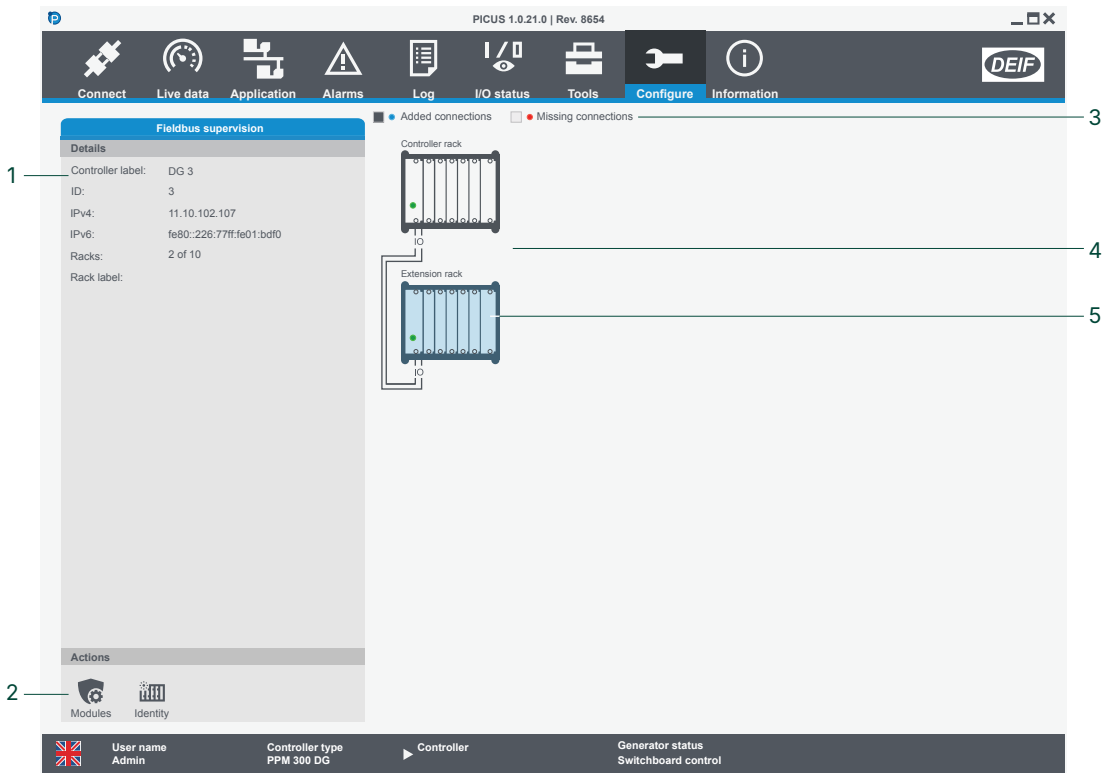

No.	Item	Notes
1	Details	Shows the communication information of the controller, the number of extension units used and the information of the selected extension unit.
2	Actions	Modules to show the modules in the selected rack. Identify supported controller.
3	Show or hide connections	Added connections: <input type="checkbox"/> Hide added connections. <input checked="" type="checkbox"/> Show added connections.
		Missing connections: <input type="checkbox"/> Hide missing connections. <input checked="" type="checkbox"/> Show missing connections.
4	Fieldbus diagram	Shows the Fieldbus configuration.
5	Selected fieldbus element	The rack that the Modules action and information are linked to.

10.8.2 Identify hardware

1. Select the controller or extension rack that you want to identify.
2. Select **Identify**.
 - The controller or extension rack now performs an identification cycle.
 - The identification LED now flashes.
 - The LED repeats a cycle of fast, medium, and slow flashing.
 - The flashing ends after 30 seconds.

10.9 Time settings

10.9.1 About Time settings

The correct date and time settings are important for operation and for the recorded events. You can configure the date and time settings manually, or use a Network Time Protocol (NTP) server to synchronise the time settings.



More information

See **Date and time** in the **Designer's handbook** for how the time settings and NTP servers work.

10.9.2 Time settings page

The screenshot displays the 'Time settings' configuration page in the DEIF PICUS 1.0.21.0 software. The interface includes a top navigation bar with icons for Connect, Live data, Application, Alarms, Log, I/O status, Tools, Configure, and Information. The main content area is titled 'Time settings' and contains three primary sections:

- Date & time:** Includes 'Date settings' with fields for 'Date format' (YYYY-MM-DD) and 'Date' (2023-08-14).
- Time settings:** Includes 'Time zone' (Etc/UTC), 'Time format' (24 hour), and 'Time' (11:03:02).
- Network time protocol settings:** Includes 'Server 1' and 'Server 2' with 'Host' and 'Mode' (Unicast) fields.

A right-hand pane provides 'Information' and 'Help' details. The 'Information' section shows: Date (2022-03-21), Time (08:58:34), Time zone (Etc/UTC), Daylight savings (Not activated), and Server connection status. The 'Help' section explains that settings are broadcasted and synchronized, and that daylight savings is applied for the selected time zone. A 'Write' button is located at the top right of the settings area. A bottom status bar displays system information: User name (Admin), Controller type (PPM 300 DG), Controller (DG 1), and Generator status (Switchboard control).

No.	Item	Notes
1	Date settings	Settings to change date format and date.
2	Time settings	Settings to change time zone, time format, and time.
3	Network time protocol settings	Settings to change the network time protocol servers.
4	Write	Writes and broadcasts the settings to the controller(s).
5	Information	Show or hide the parameter information.
6	Controller date and time	Current date and time from the controller or offline project.

10.10 Communication

10.10.1 About communication

The controller can use either IPv6 or IPv4 addresses to communicate over the Ethernet connection. Some products can configure the Ethernet ports for specific types of connection. The network mode can also be configured for the network topology.

You can run an identification of the controller to help you identify the connected controller rack.

Configure settings for:

- Controller ID.
- IPv4 address.
- DNS servers.
- Network mode.
- Ethernet ports.

Changes to the communication settings require the controller to be powered off and on.



DANGER!

Controller power supply / Access to installation



The power to the controller must be powered off and on. Only authorised personnel who understand the risks with accessing the controller power supply or installation area should do this.

Take extreme care in the enclosure next to the AC terminals. Make sure the controller is not running and in operation. The controlled breaker must be open before you power off and on the controller.

NOTICE



Cybersecurity

The DEIF controllers do not include a firewall or other Internet security measures.

It is the customer's own responsibility to protect the network. DEIF therefore recommends only connecting the controllers to local networks.



More information

See **DEIF Ethernet network** in the **Designer's handbook** for network .

10.10.2 Communication - Ethernet settings

No.	Item	Notes
1	Controller list	List of all logged on and connected controllers.
2	Actions	Write changes to the controller.
		Expand all : Expands all items in the list.
		Collapse all : Collapses all items in the list.
		Refresh : Reload communication settings.
3	IPv6	The IPv6 address of the selected controller.
4	Static IPv4	<input checked="" type="checkbox"/> Enabled uses IPv4 address settings. <input type="checkbox"/> Not enabled .
5	IPv4 settings	IPv4 address for the controller. Subnet mask address. Default gateway address.
6	DNS server settings	Preferred DNS address (primary). Alternate DNS address (secondary).
7	Controller ID	The controller ID of the selected controller.
8	Additional actions	Use Identify to start the identification of the controller. Use Reset to clear any unwritten changes.

10.10.3 Communication - Port settings

The screenshot displays the 'Port settings' configuration page in the DEIF PICUS 1.0.21.0 software. The interface is organized into several sections:

- Units (1):** A list of units on the left, including 'HYBRID 1' and 'DG 1'.
- Port settings:** The main configuration area on the right, containing:
 - Network mode settings (3):** A dropdown menu for 'Network mode' set to 'Standard node (sub-ring)'.
 - Port mode (4):** Five dropdown menus for 'Port 1' through 'Port 5', all set to 'Automatic'.
 - Diagram (5):** A visual representation of the controller with 'Front view' and 'Side view' showing the physical locations of ports 1 through 5.
- Actions (2):** A toolbar at the top right with icons for 'Write', expand/collapse, and refresh.
- Status Bar:** A bottom bar showing 'User name: Admin', 'Controller type: PPM 300 DG', 'Controller: DG 1', and 'Generator status: Switchboard control'.

No.	Item	Notes
1	Controller list	List of all logged on and connected controllers.
2	Actions	<p>Write changes to the controller.</p> <p> ⌵ Expand all : Expands all items in the list. ⌶ Collapse all : Collapses all items in the list. </p> <p> 🔄 Refresh : Reload communication settings. </p>
3	Network mode	Select the network mode for the connection in the network topology.
4	Port mode	Select the port mode for each Ethernet port.
5	Connections	Diagram shows where the Ethernet ports are located on the controller.

10.10.4 Identify controller

If you need to identify the controller rack that you are connected to, you can locate the controller rack by using **Identify**. This flashes either the Status or Power LED depending on the controller product.

To run the identification cycle

1. Select the controller from the controller list.

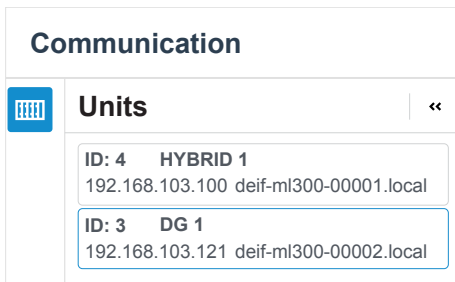

2. Select **Identify**.

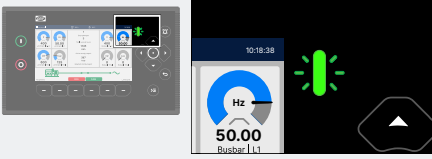
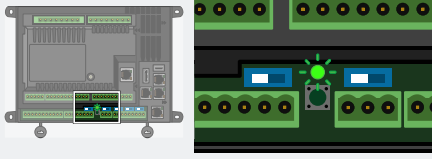
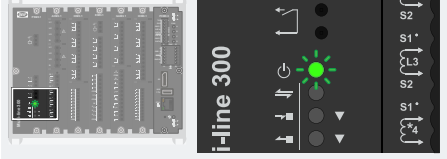
For iE 250		For iE 350 or ML 300
Panel mount	Surface mount	Surface mount
Status LED flashes	Status LED flashes	PSM Power LED flashes
		
The LED repeats a cycle of fast, medium, and slow flashing. The cycle ends after 30 seconds.		

10.10.5 Configure communication settings

Configure IP address settings

Use **Static** for IPv4 address communication.

Configure **IPv4 address**, **Subnet mask**, and **Default gateway**.

You can configure a **Preferred DNS** or **Alternate DNS** server.

Configure controller ID

The controller must be configured with the same **Controller ID** as used on the application.

Configure the **Controller ID** from the range 1 to 64.

Configure network mode

You can select the necessary network mode:

For iE 250 or iE 350	For ML 300
<ul style="list-style-type: none"> • Standard node (sub-ring) 	<ul style="list-style-type: none"> • Standard node (sub-ring) • Interconnection node (major-ring)



More information

See the **Designer's handbook** and **Installation instructions** for the supported network topologies.

Configure Ethernet port settings

For each Ethernet port you can assign the type of connection.

For iE 250 or iE 350	For ML 300
<ul style="list-style-type: none">• Automatic• External network/PICUS• Stand-alone - External configured• RSTP External• Disabled *	<ul style="list-style-type: none">• Automatic• Standard (sub-ring)• Interconnection (major-ring)• External network/PICUS• Disabled *

NOTE * One port must always remain active.

Update communication settings

Use **Write** to update the controller's communication settings.

The controller rack must be powered off and on for the changes to take effect.

11. Information

11.1 About page



The About page provides information about PICUS, the operating system, and connected controllers. It can also be useful if you need to contact DEIF support for assistance.

The screenshot shows the 'Information' page of the PICUS software. The top navigation bar includes icons for Connect, Live data, Application, Alarms, Log, I/O status, Tools, Configure, and Information. The main content area is organized into several sections:

- PICUS Information:** Displays the software version (1.0.21.0) and the REST version (1.0.5.0).
- General OS Information:** Provides details about the operating system, including the OS name (Microsoft Windows 11 Pro), platform (Windows), architecture (Intel x64), and application compilation details.
- Controller Information:** A table listing connected controllers with columns for Name, Type, Label, and CPU Load. A 'Link' is provided for the CPU Load column.
- DEIF A/S:** Contains contact and support information, including the company address, online support link, phone support number, and a copyright notice.

The bottom status bar displays the following information:

- User name: Admin
- Controller type: IE 250 GENSET
- Controller: GENSET 1
- Generator status: Ready for operation

No.	Item	Notes
1	PICUS Information	PICUS version. Highest version of REST supported by PICUS.
2	General OS information	Shows details of your computer's operating system.
3	Controller information	Shows details for the connected and logged on controllers.
4	Contact and support	Shows DEIF's contact and support information, with a direct link to the DEIF helpdesk.
5	List controls	 Expand all : Expands all items in the list.  Collapse all : Collapses all items in the list.
6	CPU Load Link	Links to a web page with an overview of the CPU load.
7	Support Link	Links to the DEIF Online Helpdesk.

12. Troubleshooting

12.1 Troubleshooting

General troubleshooting

Problem	Cause	Solution
PICUS cannot see any controllers on the Connect page.	Ethernet cable is not connected between PICUS and the controller.	Connect an Ethernet cable between your PC and the controller.
	Ethernet cable is damaged.	Replace the Ethernet cable.
	<i>Bonjour</i> is not installed.	See Apple's support page about <i>Bonjour</i> , for information and downloading: https://support.apple.com/ *
	<i>Bonjour</i> is not running.	<ol style="list-style-type: none"> 1. Open Task manager 2. Under Services, locate the Bonjour service 3. Select Start.
	<i>Bonjour</i> is running but not working.	<ol style="list-style-type: none"> 1. Open Task manager 2. Under Services, locate the Bonjour service. 3. Select Stop. 4. Select Start.
	IPv6 not enabled on PC Ethernet adapter	Open Ethernet adapter settings and enable IPv6.
	IPv6 restricted	Make sure there are no restrictions on IPv6 on your connection/network.
	Incorrect controller port settings	Check the Ethernet port settings, see Communication settings .
PICUS cannot see some controllers on the Connect page.	Duplicate IPv4 address	<ol style="list-style-type: none"> 1. Make sure there are no duplicate IPv4 addresses on other controllers or in your network. 2. Isolate the missing controller from all other Ethernet connections 3. Connect your PC directly to the controller. 4. Configure the Communication settings. 5. Power cycle the controller.
PICUS cannot connect to controllers listed on the Connect page.	Ethernet cables are not connected between PICUS and the controllers.	Connect an Ethernet cable between your PC and the controller.
	Ethernet cable is damaged.	Replace the Ethernet cable.
	IP address configured incorrectly.	Check the Ethernet port settings, see Communication settings .
	Old version of PICUS	Make sure you are running the latest version of PICUS, download the latest version from: https://www.deif.com/software/multi-line-300-picus-ver-1-x-x/ .
PICUS notifications are not shown on the display.	The computer has been locked and then unlocked.	<ul style="list-style-type: none"> • Press and hold Alt, then press Tab to cycle through open windows. • Press Windows + D to cycle through open windows.

Problem	Cause	Solution
Firmware update fails to complete.	Firmware update prerequisites are not met.	<ol style="list-style-type: none"> 1. Power off and on the controller rack. 2. Make sure all prerequisites are met. 3. Update the firmware again.
	Firmware update failed or got stuck.	<ol style="list-style-type: none"> 1. Power off and on the controller rack. 2. Launch PICUS, and with the controller selected, use the Initial DL option to update the firmware.
PICUS unable to locate previously saved files.	Files were saved on a network drive.	Move the files to a local drive.
A broadcast failed.	Ethernet cables are not connected between PICUS and the controllers.	Connect the Ethernet cables correctly.
	Ethernet cable is damaged.	Replace the Ethernet cable.

NOTE * DEIF is not responsible for external links or content.

Fieldbus troubleshooting

Problem	Cause	Solution
Fieldbus connection is missing	The cable between two racks is plugged into the same port type.	Change the <i>Topology</i> field to <i>Single connection</i> .
	Fieldbus <i>Topology</i> is set to <i>Redundancy connection</i> , but the wiring is a single connection.	Change the <i>Topology</i> field to <i>Single connection</i> .
	The cable for the highlighted missing connection is unplugged.	Connect the cable.
	The cable for the highlighted missing connection is damaged.	Replace the cable.
Fieldbus conflict	Fieldbus <i>Topology</i> is set to <i>Single connection</i> , but the wiring is a redundant connection.	Change the <i>Topology</i> field to <i>Redundant connection</i> .
	Hardware modules are removed from the unit.	Correct the fieldbus configuration.
	Hardware modules failed.	Correct the fieldbus configuration.
Fieldbus connection missing, and Fieldbus conflict	Hardware modules added to the unit.	Correct the fieldbus configuration.
	The module power supply is not connected.	Connect the power supply correctly.
	The module power supply is damaged.	Replace the power supply.
	Single connection topology: The cables are unplugged.	Connect the cables correctly.
	Single connection topology: The cables are damaged.	Replace the cables.
Fieldbus config. changed.	The controller powered up before the extension unit powered up.	Remove the controller power, then restore the controller power.
	A new extension unit was connected to the controller.	Update the fieldbus configuration to include all the connected extension units.
Fieldbus config. changed.	The hardware modules were swapped and I/O configuration - Module parameter was set to <i>Locked to position</i> .	<ol style="list-style-type: none"> 1. Place the hardware modules correctly in the rack. 2. Correct the fieldbus configuration.

Problem	Cause	Solution
Fieldbus configuration exceeded maximum I/O configuration	The number of inputs and outputs in the Fieldbus configuration exceeds the maximum for the unit.	Correct the fieldbus configuration.
AC protections not running, and System not OK	A new EtherCAT connection was plugged into the EtherCAT port while the controller did not have power.	Acknowledge the alarms and reset the latch on the <i>System not OK</i> alarm. The controller should now operate normally. Optional: To find the new EtherCAT connection for configuration, use Configure > Fieldbus configuration > Scan fieldbus .
	A new Ethernet connection was plugged into the EtherCAT port while the controller did not have power.	<ol style="list-style-type: none"> 1. Remove the Ethernet connection from the EtherCAT port. 2. Wait about one minute. 3. Acknowledge the alarms and reset the latch on the <i>System not OK</i> alarm. The controller should now operate normally.